

Remote Control System RC-100

All Sport Operation Manual

ED-15133

Rev 10 – 31 May 2016

ED-15133
Product 1110
Rev 10 – 31 May 2016

DAKTRONICS, INC.

Copyright © 2007-2016

All rights reserved. While every precaution has been taken in the preparation of this manual, the publisher assumes no responsibility for errors or omissions. No part of this book covered by the copyrights hereon may be reproduced or copied in any form or by any means – graphic, electronic, or mechanical, including photocopying, taping, or information storage and retrieval systems – without written permission of the publisher.

All Sport®, DataTime®, and OmniSport® are trademarks of Daktronics, Inc. All other trademarks used in this manual are the property of their respective owners.

Table of Contents

Section 1:	Introduction.....	1
1.1	Resources.....	1
1.2	Daktronics Exchange and Repair & Return Programs.....	2
	Exchange Program.....	2
	Before Contacting Daktronics.....	2
	Repair & Return Program.....	3
	Shipping Address.....	3
	Daktronics Warranty and Limitation of Liability.....	3
Section 2:	RC-100 System Overview.....	5
Section 3:	RC-100 Base Station.....	7
3.1	Function Setting.....	7
	Selecting Functions.....	8
	All Sport Scoreboard Controller Function.....	8
	Gen I Operation.....	8
3.2	Channel Setting.....	9
3.3	Synchronizing Multiple Base Stations and Channel Selection.....	10
	Installations with a Central Base Station.....	11
	Installations with Base Station Groups.....	12
3.4	Server/Client Mode Setting.....	13
3.5	Wireless Base Station LEDs.....	14
	LED Error Diagnostics.....	15
Section 4:	RC-100 Handheld Controller.....	17
4.1	Powering the Controller On and Off.....	17
	Using the Keypad.....	17
	Using External Power.....	17
4.2	Battery Operation.....	17
	Idle Time.....	17
4.3	Battery Recharging.....	17
4.4	Operation Modes.....	18
	Config Mode.....	18
	Setting Default Radio Channel Number.....	18
	Setting LCD Contrast.....	18
	Setting Power Save Mode.....	19
	Connect Mode.....	19
	Switching to Connect Mode.....	19
	Signal Strength Indicator.....	20
4.5	Common Keys.....	20
	Alternate Function Keys.....	21
Section 5:	All Sport Applications.....	23
5.1	Selecting All Sport Applications (Code Numbers).....	23
5.2	Keypad Inserts.....	24
	Keypad Insert Operation Concepts.....	24
5.3	Common All Sport Application Keys.....	25

	New Code (Alternate Function)	25
	New Game (Alternate Function)	25
	Start	26
	Stop	26
	Set Time	26
	UP/DN (Alternate Function).....	27
	Dim (Alternate Function)	27
	Manual Horn.....	28
	Auto Horn	28
Section 6:	Clock/Score Operation	29
6.1	Clock Score Keys	29
	Home/Guest Score +1, -1	29
	Period +1	29
	Set TOD (Alternate Function).....	29
Section 7:	Volleyball Operation	31
7.1	Volleyball Keys.....	31
	Home/Guest Score +1, -1	31
	Home/Guest Won +1, -1	31
	Reset Game Score	32
	Game +1, -1	32
Section 8:	Baseball Operation	33
8.1	Baseball Keys	33
	Home/Guest Score +1, -1	33
	Out +1, Inning +1	33
	Ball, Strike, Clear Ball & Strike	33
	Hit, Error	34
	Time, At Bat, H/E (Alternate Function).....	34
	Time/At Bat.....	34
Section 9:	Play Clock & Pitch Timer Operation.....	35
9.1	Play Clock & Pitch Timer Keys.....	35
	Set Reset 1, Set Reset 2	35
	Reset 1, Reset 2.....	35
Section 10:	Segment Timer Operation	37
10.1	Segment Timer Information.....	37
10.2	Segment Timer Keys	37
	First/Last Segment.....	37
	Segment Number/Time	38
	Interval Time.....	38
	Copy Range	39
	Auto Stop.....	39
	Warning Time	40
	Current Segment +1	40
	Reset Current Segment	40
	Reset to First Segment.....	40

Section 11:	Tennis Operation	41
11.1	Court Selection	41
11.2	Tennis Keys.....	41
	Serve.....	41
	Game +1	42
	Point.....	42
	Reset Game	42
	Tie Break.....	42
	TOD/Game.....	43
	Set +1.....	43
	Matches Won (Alternate Function).....	43
	Reset Match (Alternate Function)	43
	Next Match (Alternate Function - DakTennis Only)	44
	Winner (Alternate Function - DakTennis Only).....	44
Section 12:	Sand Volleyball Operation	45
12.1	Court Selection	45
12.2	Sand Volleyball Keys.....	45
	Serve.....	45
	Point.....	46
	Set +1.....	46
	Reset Game/Reset Match.....	46
	TOD/Game.....	47
	Matches Won (Alternate Function).....	47
	Game +1, Tie Break, Next Match, Winner	47
Section 13:	Basketball Operation.....	49
13.1	Basketball Keys.....	49
	Home/Guest Score +1, +2, (+3, -1)	49
	Fouls +1	49
	Possession.....	50
	Period +1	50
	Set TOD (Alternate Function).....	50
	1/10 SEC (Alternate Function)	50
	Bonus (Alternate Function).....	51
Section 14:	Football Operation.....	53
14.1	Football Keys	53
	Home/Guest Score +1, +6, (+3, -1)	53
	Ball On	53
	Down +1	54
	TOL -1	54
	To Go.....	54
	Possession (Alternate Function)	54
	QTR +1.....	55
Section 15:	Remote Start/Stop Operation	57
15.1	Remote Start/Stop Keys.....	57
	Start	57
	Stop	57

	Manual Horn/Reset.....	57
Section 16:	Goal Judge Operation.....	59
16.1	Goal Judge Keys	59
	Goal Light On/Off	59
Section 17:	CAN Handheld Operation	61
17.1	Common CAN Handheld Operation	61
17.2	Diving & Synchronized Swimming Operations.....	61
17.3	Rodeo Operations.....	61
Section 18:	Troubleshooting.....	63
18.1	Handheld Controller Error Messages.....	63
18.2	Base Station Errors	64
	IN RANGE LED On Start-up.....	64
	General Base Station Failures	64
	Obtaining Base Station Status Information.....	65
18.3	Replacing Handheld Battery.....	65
Appendix A:	Reference Drawings.....	67
Appendix B:	Sport Inserts	69
Appendix C:	Daktronics Warranty and Limitation of Liability	71

Section 1: Introduction

This manual is designed to explain the operation of the Daktronics RC-100 Remote Control System for All Sport® applications. For additional information regarding the safety, installation, operation, or service of this system, refer to the telephone numbers listed in **Section 1.2**.

Important Safeguards

- Read and understand all instructions, both general and for specific applications.
- Do not drop the control console or allow it to get wet.
- Do not disassemble control equipment or electronic controls of the display; failure to follow this safeguard will make the warranty null and void.
- Always turn off and/or unplug the control equipment when it is not in use. Never yank the power cord to pull the plug from the outlet. Grasp the plug and pull to disconnect.
- Do not let any power cord touch hot surfaces or hang over the edge of a table that would damage or cut the cord.
- If an extension cord is necessary, a three-pronged, polarized cord should be used. Arrange the cord with care so that it will not be tripped over or pulled out.
- Inspect console for shipping damage such as rattles and dents, and verify that all equipment is included as itemized on the packing slip. Immediately report any problems to Daktronics; save all packing materials if exchange is necessary.

1.1 Resources

Figure 1 illustrates a Daktronics drawing label. The drawing number is located in the lower-right corner of a drawing. This manual refers to drawings by listing the last set of digits and the letter preceding them. In the example, the drawing would be referred to as **Drawing C-325405**.

THE CONCEPTS EXPRESSED AND DETAILS SHOWN IN THIS DRAWING ARE CONFIDENTIAL AND PROPRIETARY. DO NOT REPRODUCE BY ANY MEANS, INCLUDING ELECTRONICALLY, WITHOUT THE EXPRESSED WRITTEN CONSENT OF DAKTRONICS, INC. COPYRIGHT 2008 DAKTRONICS, INC.			
DAKTRONICS, INC. BROOKINGS, SD 57006			
PROJ: DAKTRONICS UNIVERSITY			
TITLE: SYSTEM RISER DIAGRAM			
DES. BY: AORMESH		DRAWN BY: AORMESH	
DATE: 15 JAN 08			
REVISION	APPR BY-	14963-R01C-325405	
00	SCALE: NONE		
Drawing Number			

Figure 1: Daktronics Drawing Label

Reference Drawing:

System Riser Diagram **Drawing C-325405**

Daktronics identifies manuals by an ED or DD number located on the cover page of each manual. For example, this manual would be referred to as **ED-15133**.

1.2 Daktronics Exchange and Repair & Return Programs

Exchange Program

The Daktronics Exchange Program is a service for quickly replacing key components in need of repair. If a component fails, Daktronics sends a replacement part to the customer who, in turn, returns the failed component to Daktronics. This decreases equipment downtime. Customers who follow the program guidelines explained below will receive this service.

Before Contacting Daktronics

Identify these important numbers:

Assembly Number: _____
Job/Contract Number: _____
Date Manufactured/Installed: _____
Daktronics Customer ID Number: _____

To participate in the Exchange Program, follow these steps.

1. Call Daktronics Customer Service.

Market Description	Customer Service Number
Schools (including community/junior colleges), religious organizations, municipal clubs and community centers	877-605-1115
Universities and professional sporting events, live events for auditoriums and arenas	866-343-6018

2. When the new exchange part is received, mail the old part to Daktronics.

If the replacement part fixes the problem, send in the problem part being replaced.

- a. Package the old part in the same shipping materials in which the replacement part arrived.
- b. Fill out and attach the enclosed UPS shipping document.
- c. Ship the part to Daktronics.

3. The defective or unused parts must be returned to Daktronics within 5 weeks of initial order shipment.

If any part is not returned within five (5) weeks, a non-refundable invoice will be presented to the customer for the costs of replenishing the exchange parts inventory with a new part.

Daktronics reserves the right to refuse parts that have been damaged due to acts of nature or causes other than normal wear and tear.

Repair & Return Program

For items not subject to exchange, Daktronics offers a Repair & Return Program. To send a part for repair, follow these steps:

- 1. Call or fax Daktronics Customer Service:**
Refer to the appropriate market number in the chart listed on the previous page.
Fax: 605-697-4444
- 2. Receive a case number before shipping.**
This expedites repair of the part.
- 3. Package and pad the item carefully to prevent damage during shipment.**
Electronic components, such as printed circuit boards, should be placed in an antistatic bag before boxing. Daktronics does not recommend using packing 'peanuts' when shipping.
- 4. Enclose:**
 - name
 - address
 - phone number
 - the case number
 - a clear description of symptoms

Shipping Address

Daktronics Customer Service
[Case #]
201 Daktronics Drive, Dock E
Brookings, SD 57006

Daktronics Warranty and Limitation of Liability

The Daktronics Warranty and Limitation of Liability is located in **Appendix C**. The Warranty is independent of Extended Service agreements and is the authority in matters of service, repair, and display operation.

Section 2: RC-100 System Overview

The RC-100 system allows wireless control of multiple scoring and display applications. This system is made up of two distinct hardware components: the RC-100 wireless handheld controller, and the RC-100 wireless Base Station.

The RC-100 wireless handheld controller (**Figure 2**) includes a 4x4 keypad and a 97x32 liquid crystal display (LCD). The RC-100 wireless handheld controller is used to enter information to be displayed on a scoreboard or display. The handheld operates using a 900 MHz radio with internal antenna and comes with a rechargeable Ni-MH (Nickel Metal Hydride) 2000 mAh battery which provides 8-10 hours of operation. An RC-100 system may include multiple RC-100 wireless handheld controllers.

The RC-100 wireless Base Station processes information received from the wireless handheld controllers and sends this information to the scoreboard or another external controller. Based on the application, an RC-100 wireless receiver may be mounted inside the display (**Figure 3**), or placed in an external tabletop enclosure (**Figure 4**). An outdoor enclosure is also available for certain applications.



Figure 2: RC-100 Wireless Handheld Controller

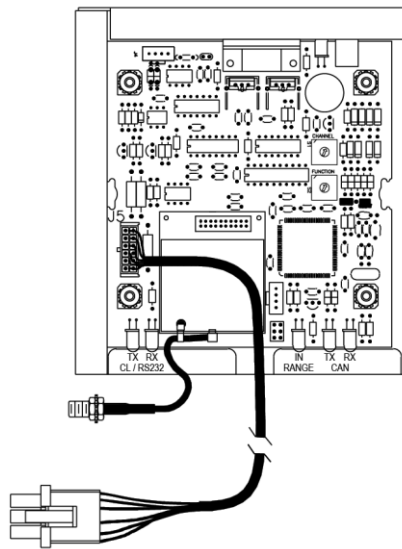

Figure 3: Internal RC-100 Receiver



Figure 4: External RC-100 Base Station (Tabletop Enclosure)

Important Installation Range Considerations

The wireless Base Station must be located at least 10' (3 m) from the wireless handheld controller and no more than 500' (152 m) away. If the wireless handheld is used outside this range, the wireless handheld signal may drop out. Ideally, the handheld controller should have a clear line-of-sight to the Base Station antenna. Make sure the Base Station antenna is pointed straight up for best reception (it should look like a capital "L" when viewed from the side).

Section 3: RC-100 Base Station

The RC-100 wireless Base Station is used to communicate with all RC-100 wireless handheld controllers on the same channel setting. The RC-100 wireless Base Station also is used to update connected displays based with information entered on the wireless handheld controller.

The wireless Base Station includes two switches that must be set to specify the function number and channel of operation. Refer to **Section 3.1** and **Section 3.2**, respectively. In addition, the Base Station includes a server/client jumper that must be set to “Client Mode” in some scenarios that feature multiple displays. Refer to **Section 3.4** for more information.

3.1 Function Setting

The desired RC-100 system function must be configured in the wireless Base Station. A list of possible current functions is shown below, along with the corresponding Function Setting.

Function Setting	Function (Base Station Server Mode*)	Function (Base Station Client Mode*)
0	Default Function (last power up function)	All Display Groups
1	CAN Handheld (Judges') Console	Display Group 1
2	GEN I All Sport Scoreboard Controller	Display Group 2
3	DataTime/Data Master Display Control	Display Group 3
4	Reserved	Display Group 4
5	GEN II All Sport Scoreboard Controller	Display Group 2
6	Reserved	
7	Reserved	
8	Reserved	
9	Reserved	
A	Reserved	
B	Reserved	
C	Reserved	
D	Reserved	
E	Reserved	
F	Reset Memory/Test**	Reset Memory/Test**

* The function of the Base Station depends on whether it is in Server or Client mode. For a server Base Station, the Function switch sets up the desired application. For a client Base Station, the Function switch sets up the display group to which this display belongs.

**Function Setting “F” is a special setting which resets all saved memory parameters back to defaults. This can be used for situations such as when a password needs to be reset. To use this function, cycle power to the wireless Base Station with the switch in this position and leave on for 10 seconds. Remove power, change to the desired function and continue. All saved memory parameters will be set back to default.

Selecting Functions

Refer to **Figure 5** for the wireless Base Station circuit board assembly drawing.

To access the circuit board:

- For external Base Station enclosures, remove the two screws securing the top cover, and lift it off.
- For internal Base Stations, refer to the scoreboard/display manual for component location and access instructions.

After exposing Base Station circuit board, use a small flathead screwdriver to turn the “S2” rotary switch labeled “FUNCTION” to the desired Function Setting.

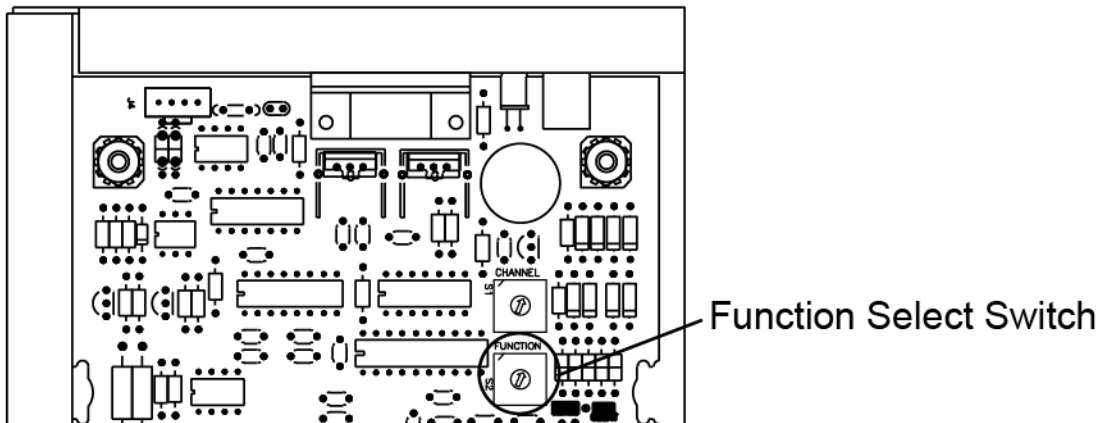

Figure 5: Function Select Switch (Internal Receiver)

After 5 seconds, the wireless Base Station Server will change its function to match the new switch setting. (Any connected wireless handheld controllers should change as well.)

When the wireless Base Station Server is turned off and back on, it will always default to the function set on the switch.

All Sport Scoreboard Controller Function

The All Sport Scoreboard Controller will normally operate with the Function Setting “5” selected. However, to support legacy products, Gen I mode of operation may be selected by switching the Function Setting to “2”.

Gen I Operation

Function Setting “2” allows Daktronics Gen I handheld controllers to communicate with Gen II Base Stations.

Gen II handheld controllers will recognize which generation Base Station they are communicating with. On first time power-up, the initialization of the radio will take a little longer while it attempts to recognize which generation Base Station is present.

After a successful connection, the handheld controller will recognize and connect immediately with that generation of Base Station.

Keep in mind the following when using the Gen I mode of operation:

- Gen I handheld controllers or Base Stations will not operate in Function “5”.
- All Base Stations operating at the same location must be set to the same Function.
- Gen I handheld controllers display ED14905 Version 1.6 or lower on the LCD at power-up. Gen I Base Stations are labeled ED14906 Version 2.1 or lower.
- Gen II handheld controllers display ED14905 Version 2.2 or higher on the LCD at power-up. Gen II Base Stations are labeled ED14906 Version 2.2 or higher.

3.2 Channel Setting

The wireless Base Station and wireless handheld device use internal radio modules to communicate. The radios on both the wireless handheld and wireless Base Station device can be set to any channel ranging from 1-15. “Channel 1” is the default channel used by Daktronics for single base-station installations.

Refer to **Figure 6** for the wireless Base Station circuit board assembly drawing. To access the circuit board:

- For external Base Station enclosures, remove the two screws securing the top cover, and lift it off.
- For internal Base Stations, refer to the scoreboard/display manual for component location and access instructions.

After exposing Base Station circuit board, use a small flathead screwdriver to turn the “S1” rotary switch labeled “CHANNEL” to the desired channel.

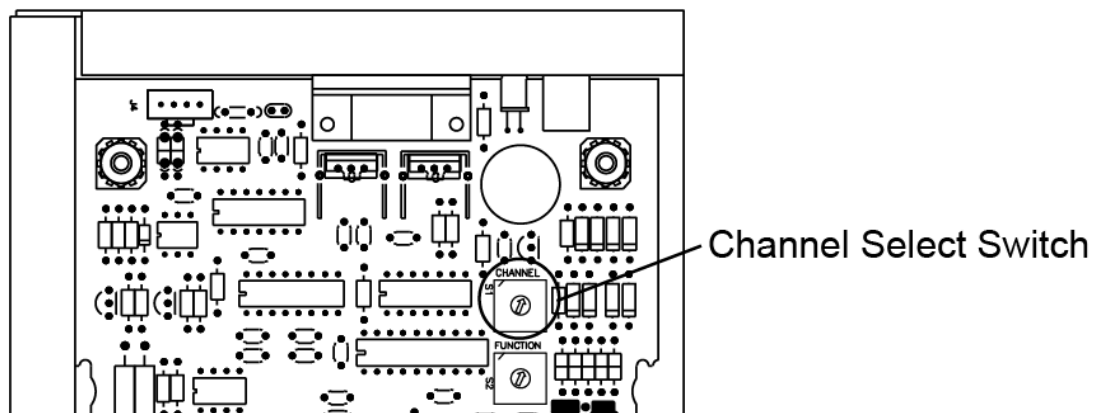

Figure 6: Channel Select Switch (Internal Receiver)

Note: The wireless handheld and Base Station must be set to the same channel in order to communicate. To select the channel in the wireless handheld controller, refer to **Section 4.1**.

Two server Base Stations cannot be powered up in the same area with the same channel setting, or they will interfere with each other. To avoid this, on power-up the server Base Station checks to see if there are any other servers located nearby. If another server is detected, the “IN RANGE” LED (**Figure 10**) will flash quickly to indicate interference, and continue to flash until the channel is changed or the conflicting Base Station is turned off.

3.3 Synchronizing Multiple Base Stations and Channel Selection

If two or more server Base Stations need to operate at the same time in the same location, they must each be set to an independent channel and synchronized accordingly.

The RC-100 wireless system uses frequency-hopping technology to maximize range and minimize interference from other systems. When multiple server Base Stations are installed within range of each other (approximately 2000 feet), Base Stations must be able to synchronize with one another to ensure their hop sequences do not interfere with each other.

This is accomplished by the use of sync groups. A list of the sync groups and their corresponding channel numbers and channel groups are shown in the table below.

Sync Group	Channel Number	Primary Channel Group	Extended Channel Group
1	0	All	
2	1	2, 3, 4, 5	7, 8, 9, 10, 12(C), 13(D), 14(E), 15(F)
3	6	7, 8, 9, 10	12(C), 13(D), 14(E), 15(F)
4	11(B)	12(C), 13(D), 14(E), 15(F)	

The “Channel Number,” “Primary Channel Group”, and “Extended Channel Group” entries correspond to the settings on the CHANNEL rotary switch (**Figure 6**) and handheld settings that pertain to the “Sync Group” shown on the same line. Each “Primary Channel Group” lists the channels that will attempt to synchronize to this sync channel as a first choice. If any Base Stations set to these “Primary Channels” are within range of a Base Station set to the corresponding sync channel number, the two Base Stations will sync. The “Extended Channel Group” lists channels that attempt to synchronize to the corresponding sync channel as a second or third choice. When these channels are not within range of their primary sync channel, they will attempt to synchronize to the corresponding sync channel.

When a Base Station is synchronized to a Sync Group, the “IN RANGE” LED (**Figure 10**) will flash briefly approximately every 5 seconds with the number of times flashed corresponding to the sync group: 1 = Channel 0, 2= Channel 1, 3=Channel 6, 4= Channel 11 (B).

Any Base Stations set to channels in the “Channel Groups” section will continuously scan for sync Base Stations whenever no handheld controllers are connected. This will allow these boards to be powered up in any sequence and still obtain network synchronization.

Installations with a Central Base Station

If the installation includes a central Base Station located approximately 3000' (914 m) or closer to all other Base Stations, a Base Station set on channel 1 may be installed in this location. All other Base Stations may be set to values in the primary and extended channel groups for this channel number to avoid interference within the channels. **Figure 7** shows an example of a baseball facility with 9 diamonds, each having its own server Base Station.

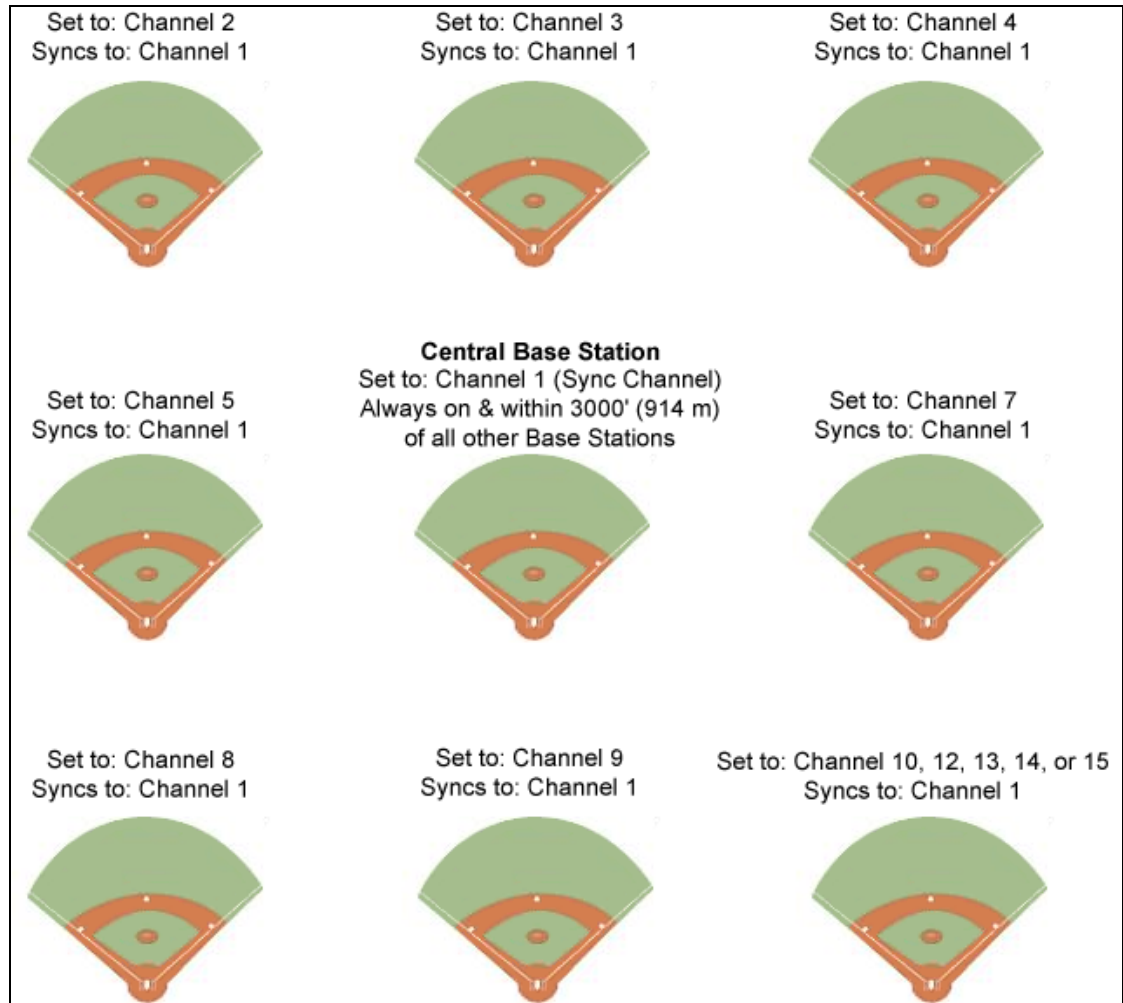

Figure 7: Multiple Base Stations w/ Central Location

Note: In order to remain synchronized with one another, no Base Station in the area may be set to channel 6 or 11. Also, the central Base Station must remain on at all times during the operation of any other Base Station.

Installations with Base Station Groups

If the installation does not include a central location as described above, or if groups of Base Stations will be powered down at times, other groups will need to be active and using Sync Groups 3 and 4 (channels 6 and 11).

An operator may use Sync Groups 3 and 4 (channels 6 and 11) as synchronizing channels for two other independent groups of scoreboards that may or may not be in range of any other groups. **Figure 8** shows an example of a baseball facility that also has 9 diamonds; however, in this setup there is no central location and instead uses 3 independent channel groups.

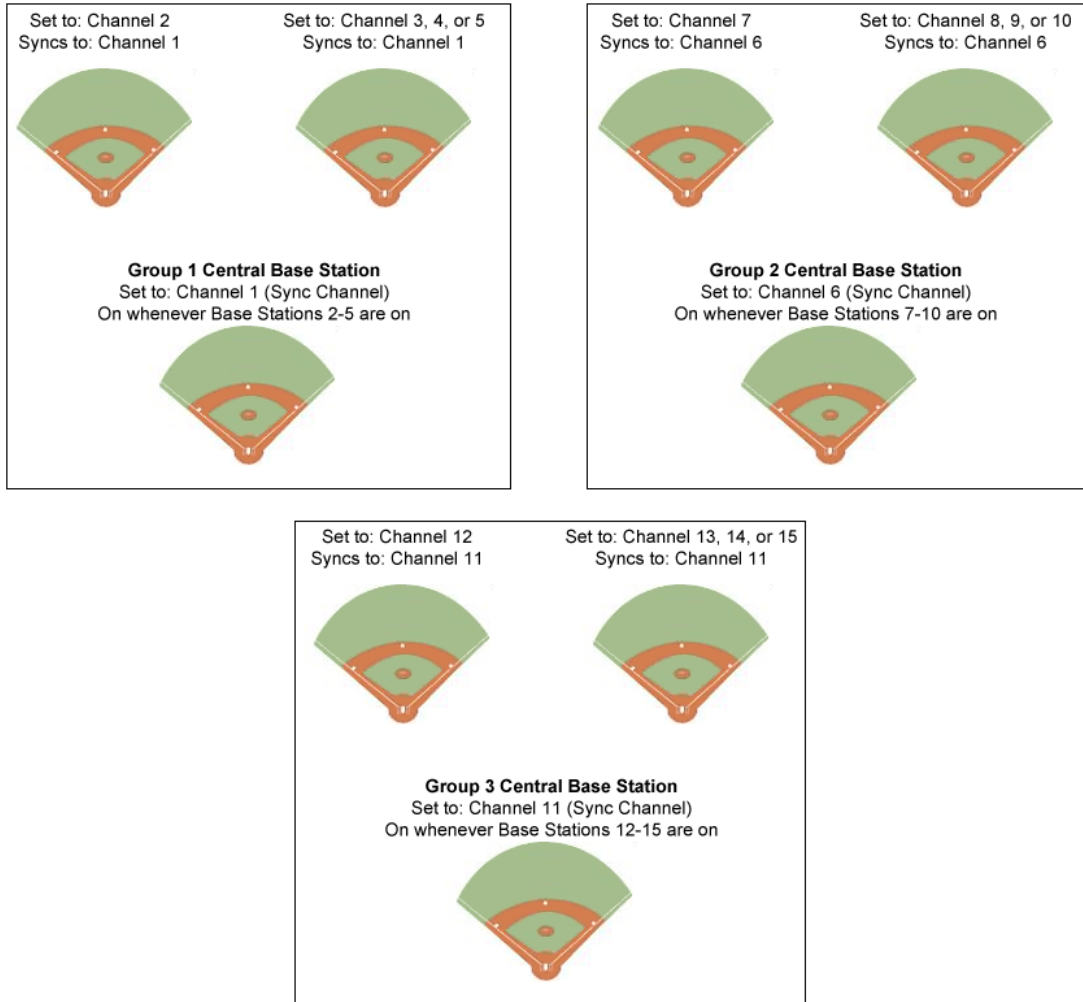

Figure 8: Multiple Base Station Groups

Note: An important limitation exists for channels 1, 6, and 11. Since other channels use these channels for synchronization purposes, Base Stations on these channels cannot scan during normal operation, only at power-up. For this reason, these Base Stations must be powered up in-order (1 first, then 6, then 11) in order to maintain overall network synchronization in the case where it is needed to have Channels 1, 6, and 11 all powered up at the same time.

3.4 Server/Client Mode Setting

The RC-100 wireless Base Station can operate in either Server Mode or Client Mode, depending on application requirements. For most applications, the wireless Base Station will operate in Server Mode, and no change from the default setting will be necessary.

In **Server Mode**, the wireless Base Station controls all wireless handheld devices, either through an onboard program (i.e. All Sport® or DataTime®), or by acting as a router to pass data back and forth between wireless handheld devices and an external control system (such as an OmniSport® 2000 console). An RC-100 network (on a single channel) contains **one and only one** server Base Station device.

In **Client Mode**, a wireless Base Station relies on another server Base Station to supply it with data. This client Base Station will typically provide data for a second wireless scoreboard or display, as needed for All Sport or DataTime functions. Since the Function Select switch is not needed to select a function when the Base Station is in Client Mode, the function switch selects the display group instead. For more information refer to **Section 3.1**.

Refer to **Figure 9** for the wireless Base Station circuit board assembly drawing. To access the circuit board:

- For external Base Station enclosures, remove the two screws securing the top cover, and lift it off.
- For internal Base Stations, refer to the scoreboard/display manual for component location and access instructions.

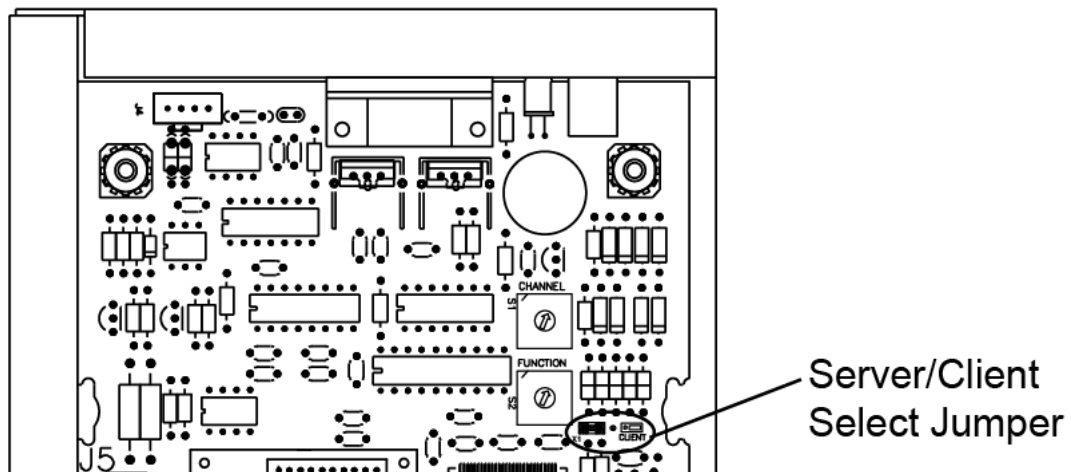

Figure 9: Server/Client Select Jumper (Internal Receiver)

Wireless Base Station Server/Client Mode is selected via the “X1” Server/Client Jumper. Insert the jumper over the top two posts as shown in the “CLIENT” label on the circuit board to put the wireless Base Station in Client Mode. For Server Mode, leave the jumper over the bottom two posts (factory default).

Drawing A-317837 in **Appendix A** shows an example of how a server/client system is used to operate two game timers at opposite ends of a football field.

3.5 Wireless Base Station LEDs

The wireless Base Station circuit board includes several light-emitting diodes (LEDs) for diagnostic purposes, as shown in **Figure 10** and described in the table that follows.

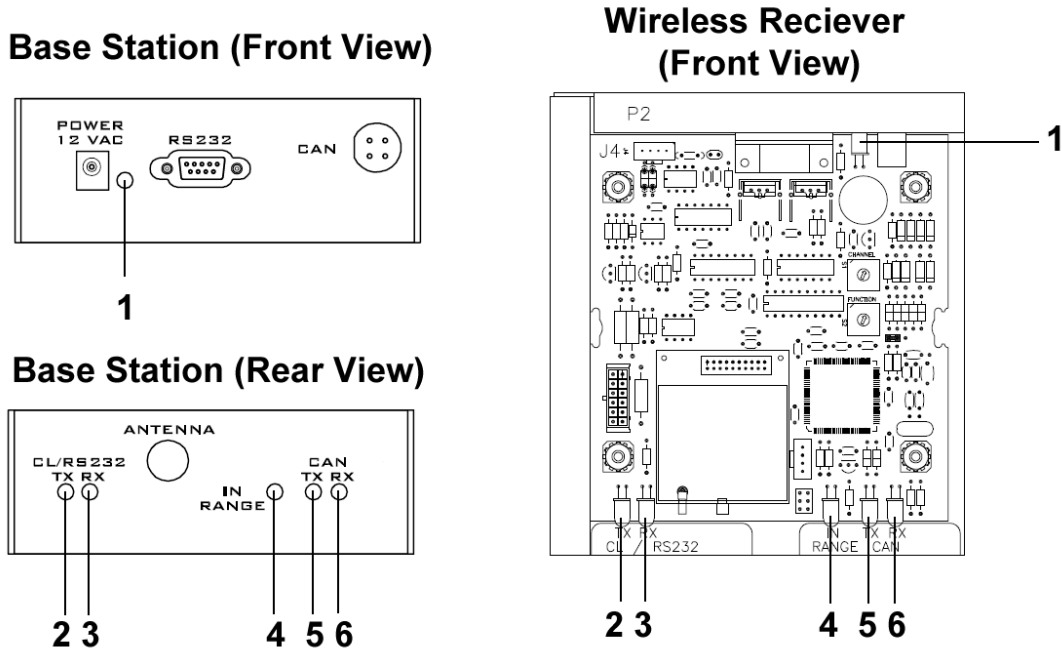

Figure 10: Wireless Base Station LEDs

#	LED	Color	Function
1	POWER	Green	This LED illuminates when the Base Station or receiver is connected to a power source.
2	CL/RS232 TX	Red	This LED flashes when the Base Station transmits Current Loop (CL) or RS-232 data via wire: <ul style="list-style-type: none"> • Current Loop output is used to control scoreboards. • RS-232 output is used to communicate with external devices, such as a computer with DakTennis™.
3	CL/RS232 RX	Green	This LED flashes when the Base Station receives Current Loop (CL) or RS-232 data from another device via wire.
4	IN RANGE	Amber	On a server Base Station, this LED flashes several times at start-up to indicate that it is searching for other server Base Stations on the same channel within range. If one is found, this LED flashes continuously to indicate that only one server Base Station is allowed on a given channel. Once in operation mode, this LED will either be on or off to indicate whether or not one or more handheld devices are currently connected to the Base Station. On a client Base Station, this LED is on whenever it is connected to a server Base Station. This LED also shows sync status. Refer to the Section 3.3 .

5	CAN TX	Green	This LED flashes when Controller Area Network (CAN) data is transmitted to a connected device, such as the OmniSport 2000 console.
6	CAN RX	Red	This LED flashes when Controller Area Network (CAN) data is received from a connected device, such as the OmniSport 2000 console.

LED Error Diagnostics

The CL/RS232 TX, CL/RS232 RX, IN RANGE, and CAN TX LEDs are also used to display errors that can occur in wireless Base Station operation. Refer to **Section 18** for more information about these errors.

Section 4: RC-100 Handheld Controller

4.1 Powering the Controller On and Off

Using the Keypad

- Press and hold the <ON/OFF> key momentarily to power on the controller. If the LCD does not display text within a few seconds, the internal battery is most likely dead and will need to be recharged (refer to **Section 4.3**).
- Press and hold the <ON/OFF> key for 5 seconds to power off the controller. The LCD will display a power down message.

Using External Power

Plugging the wireless handheld controller into an external power source via the power connector on top of the unit will turn it on (and charge its internal batteries). The wireless handheld will not turn off if connected to external power. When connected to external power, the top line of the LCD will show a power plug (**Figure 11**).

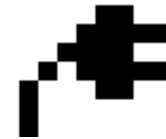

Figure 11: External Power Detect Status

When external power is removed and charging is complete, the handheld will power down after a 5 second prompt to conserve battery power. Press any key during the prompt after disconnecting external power to keep the handheld controller powered on.

4.2 Battery Operation

When the controller is powered on, an indicator on the top line of the LCD shows the current battery status (**Figure 12**). The three segments within the battery will gradually disappear as the battery loses its charge.



Figure 12: Battery Status

Idle Time

When using battery power, by default the controller shuts itself off or “sleeps” automatically after 45 minutes of inactivity. The idle time setting may be turned off (refer to **Section 4.4**), but to increase battery life, be sure to manually turn the console off when it will be inactive for a long period of time.

4.3 Battery Recharging

A charger is contained inside the wireless handheld controller for re-charging the batteries. To recharge the batteries when not in use, simply connect an external power source to the power connector on top of the unit. A completely discharged battery will take approximately 1.5 hours of fast charging to recharge. For information on battery replacement, see **Section 18.3**.

A 12 VAC wallpack transformer (Daktronics part # T-1118) is included with the wireless handheld controller for recharging the batteries and providing external power. Daktronics also offers a charging station capable of recharging up to 6 units at a time. Refer to **Drawing A-231674** in **Appendix A** for more information on charging station operation.

4.4 Operation Modes

The RC-100 wireless handheld controller (**Figure 2**) always operates in one of two modes: Config or Connect.

Config Mode

Config (“configuration”) mode (**Figure 13**) is used when a wireless server Base Station is not controlling a wireless handheld. Config mode is used to set up operational settings in the wireless handheld controller.

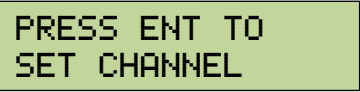
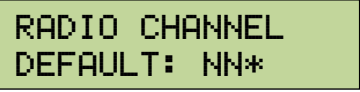

Figure 13: Config Mode LCD Icon

If the wireless handheld has not yet been configured for a specific channel, the Config mode will start automatically when the device is first powered on. If it has been previously configured, the wireless handheld will attempt to connect at the last connected channel.

- Configuration mode may be entered at any time by pressing and holding the <CONFIG> key for 5 seconds.
- Use the <↑> and <↓> arrow keys to move through the possible configuration items.

Setting Default Radio Channel Number

Display	Action
	Press <ENTER> to set the default radio channel number.
 <p>NN = Current Channel Number (Default: 1)</p>	Use the number keys to enter the desired channel number. Press <ENTER> again to save the setting. Note: The channel number should match the setting on the desired wireless Base Station to connect to on power-up. Refer to Section 3.2 for more information on setting the Base Station channel number.

Setting LCD Contrast

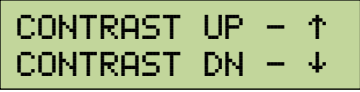
Display	Action
	Press <ENTER> to set the contrast level.
	Use the up or down arrow keys on the keypad to set the desired contrast. Press <ENTER> again to save the setting.

Setting Power Save Mode

Display	Action
<p>PRESS ENT TO SET PWR ON TIME</p>	<p>Press <ENTER> to set the power off (idle) time. With this setting enabled, the controller will turn off automatically after 45 minutes of inactivity.</p>
<p>Power Save: ON ↑ or ↓ to Set</p>	<p>Use the up or down arrow keys on the keypad to turn the power save mode ON or OFF.</p> <p>Press <ENTER> again to save the setting.</p>

Connect Mode

Connect mode (Figure 14) is used when the wireless handheld is connected to a wireless server Base Station. In Connect mode, the wireless Base Station determines the operation of the handheld, and all operation is specific to the wireless Base Station Function selected.



Figure 14: Connect Mode LCD Icon

Switching to Connect Mode

After all initialization and configuration is complete, the wireless handheld controller will be ready to connect to a wireless Base Station.

Display	Action
<p>INITIALIZING RADIO</p>	<p>Press <CONNECT> to create a connection to an available wireless Base Station on the channel shown.</p>
<p>CONNECTING VIA CHANNEL NN*</p> <p>NN = Channel Setting</p>	<p>Note: The Wireless Base Station must be powered on and must be set to the specified channel.</p> <ul style="list-style-type: none"> • If a connection was made, the wireless handheld will be operating in Connect mode. Refer to the application-specific sections for operation details. • If a connection could not be made, refer to Section 18 for information about how to resolve the problem.

Signal Strength Indicator

Once a connection has been made, the top line of the LCD will show the signal strength (**Figure 15**). This indicator shows the approximate signal strength of the network connection. Each successive bar indicates an additional level of signal strength between the handheld and Base Station.



Figure 15: Signal Strength

When no bars or 1 bar is visible, the connection to the wireless network is likely to be limited, and the console may occasionally fail to respond. To improve signal strength, move within range of the Base Station, and remove any obstacles located between the Base Station and handheld controller if possible. For more information, refer to **Section 2**.

4.5 Common Keys

Several keys on the default keypad layout are common to multiple wireless handheld applications. These keys are noted in **Figure 16**. For a description of the function of keys for a particular application, refer to the application-specific sections of this manual.

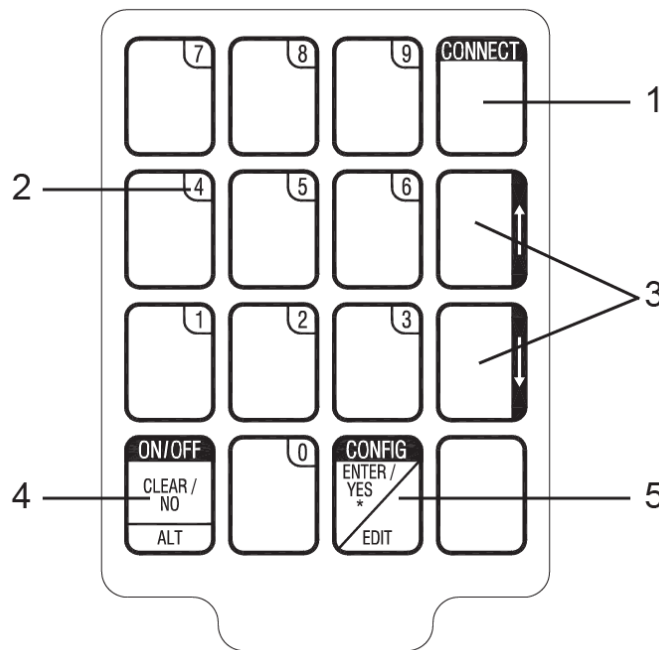

Figure 16: Common RC-100 Keys

#	Key	Function
1	CONNECT	This key is used to connect to a wireless Base Station. Refer to Section 4.4 for more information. Pressing <ALT> followed by <CONNECT> when a connection is made to a wireless Base Station will show Base Station synchronization and revision information. Refer to Section 18.2 for more information.
2	Numbers	These keys are used for numeric entry functions. While a particular key may normally be assigned to application-specific functions, in an Edit routine, they are also used to enter the number shown in the corner of the key.

3	Up/Down Arrows	These keys are used to navigate through menu choices and make certain selections. Arrows may also be assigned to application-specific functions.
4	ON/OFF CLEAR/NO ALT	<p>The ON/OFF operation of this key is described in Section 4.1.</p> <p>The CLEAR operation of this key pertains to editing and data entry routines. When editing a value, press <CLEAR> to remove that value. The CLEAR operation may also be used to escape out of an editing function. If a key was pressed inadvertently, or if the value being edited should not be changed, pressing <CLEAR> twice exits the editing routine without modifying the value.</p> <p>The NO operation of this key also pertains to editing and data entry routines. When a question prompt is shown on the LCD, press this key to answer the question with a “No.”</p> <p>The ALT operation of this key selects alternate actions for certain application keys. Press this key before pressing another key to activate a secondary function. Refer to the section following this table for more information.</p>
5	CONFIG ENTER/YES EDIT	<p>The CONFIG operation of this key is described in Section 4.4.</p> <p>The ENTER function of this key pertains to editing and data entry routines. After editing a value, press <ENTER> to save the change.</p> <p>The YES function of this key also pertains to editing and data entry routines. When a question prompt is shown on the LCD, press this key to answer the question with a “Yes.”</p> <p>The EDIT function of this key is used to edit the data associated with a particular key. For instance, pressing <EDIT> followed by a “+1” key will allow the operator to manually type in a new value using the number keys. Refer to the application-specific sections for more information about which keys have EDIT functionality.</p>

Alternate Function Keys

An alternate function of a key, if applicable, will be shown on the bottom the key below a horizontal line. Refer to **Figure 17** for an example.

- Press the key once to run the primary function.
- Press **<ALT>** followed by the key to run the alternate function.

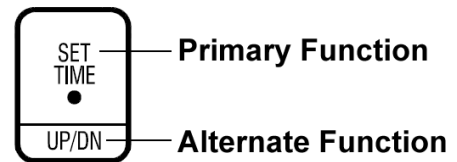

Figure 17: Key with ALT Functionality

Section 5: All Sport Applications

This section provides information about the “All Sport” function of the RC-100 wireless Base Station. Refer to the sections following this section for sport-specific operation.

5.1 Selecting All Sport Applications (Code Numbers)

To select a specific All Sport application (such as baseball, tennis, etc.) the “All Sport” function must first be set in the wireless Base Station (refer to **Section 3.1**).

Once the All Sport *function* has been selected, an All Sport *application* may be selected by entering a specific code number on the wireless handheld controller. This number is typically located on the bottom center of the keypad insert. These numbers are also listed in **Section 5.2** and in the application-specific sections.

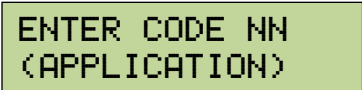
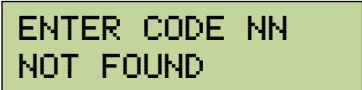
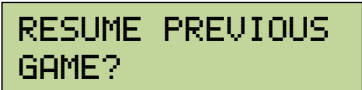
Display	Action
 <p>ENTER CODE NN (APPLICATION)</p> <p>NN = current setting</p>	<p>Enter the code number corresponding to the application using the number keys on the keypad. When the code number is correctly selected, a short description will be shown on the bottom line of the LCD.</p> <p>Note: Since the wireless Base Station is typically used with a single application, once the code number has been set, the wireless Base Station will continue to use the same code number each time power is reset. To change code numbers, use the <NEW CODE> key on the wireless hand-held. Refer to Section 5.3 for more information.</p>
 <p>ENTER CODE NN NOT FOUND</p>	<p>“NOT FOUND” is shown on bottom line of the LCD if the specified code number was not available. This typically means either the code was entered incorrectly, or the Base Station firmware does not support it. If this is a new code number that is not supported, the Base Station will need to be either replaced or reprogrammed. Contact Daktronics Customer Service. Refer to Section 1.2.</p>
 <p>RESUME PREVIOUS GAME?</p>	<p>If the handheld controller is powered down and powered back on, the question at left will appear. Press <YES> to retain the previously-entered settings, or press <NO> to start a new game under the last code entered.</p>

Note: For RC-100 systems using a Controller Area Network (CAN), it will not be necessary to enter a sport code. Instead, the RC-100 will automatically detect the operation mode when it is correctly connected to a controller (typically an OmniSport 2000 console).

5.2 Keypad Inserts

Keypad inserts allow a single console to control multiple sports and applications. Select the proper insert from the chart below and slide it into the opening on the bottom of the controller until it stops. To remove an insert, pull on the tab that extends from the controller.

If an insert is lost or damaged, a copy of the sport insert drawing, located in **Appendix B**, can be used until a replacement can be ordered.

Sport/Application	Insert Number	Code
Clock/Score	LL-2613	01
Volleyball	0G-239304	02
Baseball	LL-2605	03, 23
Play Clock / Pitch Timer	LL-2653	05
Segment Timer	LL-2613	06
Tennis	LL-2607	08
Sand Volleyball	LL-2607	09
Basketball	LL-2632	10
Football	0G-1031603	61, 62
Remote Start/Stop	0G-319079	98
Goal Judge	LL-2663	99
Judge's Console (CAN)	LL-2606	N/A
Rodeo (CAN)	LL-2608	N/A

Keypad Insert Operation Concepts

A keypad insert identifies the keys required for normal operation of a specific sport or application. In most cases, pressing a key immediately changes the scoreboard/display. Keys that require entry of additional information are marked by a dot, (such as **<SET TIME •>**). This additional information is usually a number followed by the **<ENTER>** key.

Some keys are labeled **+1**. Pressing one of these keys once “increments”, or increases, the corresponding field on the scoreboard by one (such as score or period). A key with **-1** “decrements”, or decreases, by one.

On some inserts, certain keys have been grouped together under the heading **HOME** or **GUEST**. These keys are **team** keys and work the same for both teams. They affect the statistics only for that one team. Keys not under one of these headings are **Game** keys. They are general keys for the progress of the game (such as period or quarter). Other keys may be grouped in a similar way to emphasize that they work together.

5.3 Common All Sport Application Keys

Several All Sport applications provide keys with the same functionality, as described below.

Note: For other common wireless handheld keys, refer to **Section 4.5**.

New Code (Alternate Function)

The New Code key (**Figure 18**) is used to select a new code number and change the current All Sport application.

Applies to: Baseball, Basketball, Clock/Score, Football, Goal Judge, Play Clock/Pitch Timer, Segment Timer, Tennis, Volleyball, Sand Volleyball

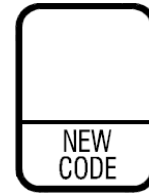

Figure 18: New Code Key

Display	Action
PRESS ENT TO SELECT NEW CODE	<p>This key is typically implemented as an alternate function. Press <ALT> followed by <NEW CODE>.</p> <p>Press <ENTER> to select a new code number. Refer to Section 5.1.</p> <p>Note: All data for the current application will be lost.</p> <p>Press <CLEAR> to cancel and resume normal operation.</p>

New Game (Alternate Function)

The New Game key (**Figure 19**) is used to reset all current game data for a specific application. Use it to prepare for a new game by removing all data from the display.

Applies to: Baseball, Basketball, Clock/Score, Football, Volleyball

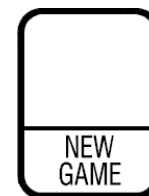

Figure 19: New Game Key

Display	Action
PRESS ENT TO SELECT NEW GAME	<p>This key is typically implemented as an alternate function. Press <ALT> followed by <NEW GAME>.</p> <p>Press <ENTER> to start a new game.</p> <p>Note: All data for the current or last game in progress will be lost.</p> <p>Press <CLEAR> to cancel and resume normal operation.</p>

Start

Press <START> (Figure 20) to start the main clock.

Applies to: Baseball, Basketball, Clock/Score, Football, Play Clock/Pitch Timer, Remote Start/Stop, Sand Volleyball, Segment Timer, Tennis

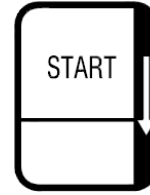

Figure 20: Start Key

Stop

Press <STOP> (Figure 21) to stop the main clock.

Applies to: Baseball, Basketball, Clock/Score, Football, Play Clock/Pitch Timer, Remote Start/Stop, Sand Volleyball, Segment Timer, Tennis



Figure 21: Stop Key



Set Time

The Set Time key (Figure 22) is used to set or adjust the game time after the game clock has been stopped (or before it has started).

Applies to: Basketball, Clock/Score, Football, Play Clock/Pitch Timer, Sand Volleyball, Segment Timer, Tennis

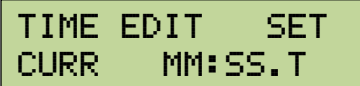

Figure 22: Set Time Key

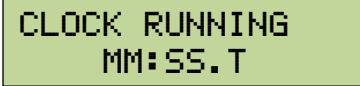
Display	Action
 <p>TIME EDIT SET CURR MM:SS.T</p>	<p>Press <SET TIME •> to display the current clock time. To change the time, enter the desired value the using the number keys on the keypad and press <ENTER>.</p>
 <p>TIME EDIT SET PERIOD MM:SS.T</p> <p>MM:SS.T = minutes, seconds, tenths of a second</p>	<p>Press <SET TIME •> twice to display the Period time. To change the time, enter the desired value the using the number keys on the keypad and press <ENTER>. This replaces the Current time and becomes the default Period time for new games.</p>
 <p>CLOCK RUNNING MM:SS.T</p> <p>(Only basketball supports tenths of a second; baseball supports hours, minutes, and seconds)</p>	<p>Press <CLEAR> twice to cancel any changes and return to the game.</p> <p>If the clock is running when the <SET TIME •> key is pressed, the message at left will appear briefly. This feature may be used to view the current clock time on the controller.</p>

UP/DN (Alternate Function)

The UP/DN key (Figure 23) is typically the alternate function of the Set Time key. This key lets the operator select whether the game clock counts up to the set time or counts down from the set time.

Applies to: Basketball, Clock/Score, Football, Play Clock/Pitch Timer, Sand Volleyball, Segment Timer, Tennis

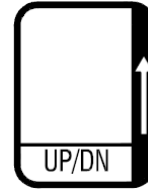

Figure 23: UP/DN Key

Display	Action
	<p>This key is typically implemented as an alternate function. After the main clock has been stopped, press <ALT> followed by <UP/DN> to set the direction of the clock.</p> <p>Press <1> or <2> to select UP or DOWN (default). The current direction of the clock is shown by an arrow on the LCD.</p>

Dim (Alternate Function)

The Dim key (Figure 24) sets the dimming level (brightness) of the display.

Applies to: Baseball, Basketball, Clock/Score, Football, Play Clock/Pitch Timer, Sand Volleyball, Segment Timer, Tennis, Volleyball

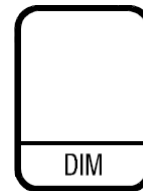

Figure 24: Dim Key

Display	Action
<p>NN = current level NONE = bright <0> 90% = <1> 80% = <2> 70% = <3> 60% = <4> 50% = <5> 40% = <6> 30% = <7> 20% = <8> 10% = <9></p>	<p>This key is typically implemented as an alternate function. Press <ALT> followed by <DIM> to view the current dimming level.</p> <p>Press <0> through <9> to change the dimming level. Press <ENTER> to save.</p> <p>Press <CLEAR> to cancel and resume normal operation.</p>

Manual Horn

Press the <MANUAL HORN> key (Figure 25) to sound the horn. The horn sounds as long as the key is pressed and stops sounding when the key is released.

Applies to: Basketball, Clock/Score, Football, Remote Start/Stop, Sand Volleyball, Segment Timer, Tennis



Figure 25: Manual Horn Key

Auto Horn

Use the Auto Horn key (Figure 26) to set whether the horn sounds automatically when the main clock reaches 0:00.

Applies to: Basketball, Clock/Score, Football, Segment Timer

Note: For Football, the Auto Horn is an alternate function.

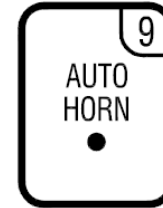

Figure 26: Auto Horn Key

Display	Action
	Press <AUTO HORN> and then press <1> or <2> to select ON (default) or OFF.

When Auto Horn is enabled, a small 'h' will appear under the clock direction arrow on the LCD. Figure 27 shows an example where the clock is counting down and the auto horn is enabled.



Figure 27: Auto Horn Indicator

Section 6: Clock/Score Operation



Sport Insert: LL-2613

Code: 01 (Use Code 11 for optimized server/client operation.)

The sport insert drawing is located in **Appendix B**. If an insert is lost or damaged, a copy of the insert drawing can be used until a replacement arrives. Refer **Section 4.1** for information on starting the console and **Section 5.3** for additional All Sport application keys.

6.1 Clock Score Keys

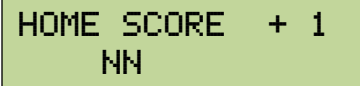
Home/Guest Score +1, -1

Display	Action
	Press the appropriate HOME or GUEST <SCORE +1> or <SCORE -1> key to increment or decrement the total number of points for the team.
 NN = current setting	To manually change values, first press <EDIT> then either <SCORE +1> or <SCORE -1> to display the current setting. Enter the correct number using the keypad and press <ENTER> to save.

Period +1

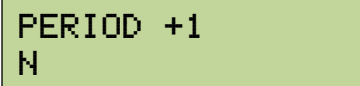
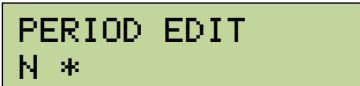
Display	Action
	Press <PERIOD +1> to increment the current period number.
 NN = current setting	To manually change values, first press <EDIT> then <PERIOD +1> to display the current setting. Enter the correct number using the keypad and press <ENTER> to save.

Set TOD (Alternate Function)

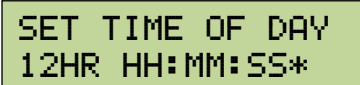
Display	Action
 HH:MM:SS = hours, mins, secs	Press <ALT> followed by <SET TOD> to set the Time of Day. Enter the correct number using the keypad and press <ENTER> to save. The time of day clock is now displayed, if the scoreboard has that capability.

Section 7: Volleyball Operation

Sport Insert: 0G-239304

Code: 02

The sport insert drawing is located in **Appendix B**. If an insert is lost or damaged, a copy of the insert drawing can be used until a replacement arrives. Refer **Section 4.1** for information on starting the console and **Section 5.3** for additional All Sport application keys.

7.1 Volleyball Keys

Home/Guest Score +1, -1

Display	Action
<pre>HOME SCORE + 1 NN</pre>	Press the appropriate HOME or GUEST <SCORE +1> or <SCORE -1> key to increment or decrement the total number of points for the team.
<pre>HOME SCORE EDIT NN*</pre> <p>NN = current setting</p>	To manually change values, first press <EDIT> then either <SCORE +1> or <SCORE -1> to display the current setting. Enter the correct number using the keypad and press <ENTER> to save.

Home/Guest Won +1, -1

Display	Action
<pre>HOME WON + 1 NN</pre>	Press the appropriate HOME or GUEST <WON +1> or <WON -1> key to increment or decrement the total number of games won for the team.
<pre>HOME WON EDIT NN*</pre> <p>NN = current setting</p>	To manually change values, first press <EDIT> then either <WON +1> or <WON -1> to display the current setting. Enter the correct number using the keypad and press <ENTER> to save.

Reset Game Score

Display	Action
<pre>RESET GAME? ENTER TO ACCEPT</pre>	Press <RESET GAME SCORE> followed by <ENTER> to reset both home and guest scores to zero. This key is used to clear the Game Score fields at the beginning of each match.

Game +1, -1

Display	Action
<pre>GAME # +1 N</pre>	Press <GAME +1> to increment the current game number, or press <GAME -1> to decrement the number.
<pre>GAME # EDIT N*</pre> <p>N = current setting</p>	To manually change values, first press <EDIT> then either <GAME +1> or <GAME -1> to display the current setting. Enter the correct number using the keypad and press <ENTER> to save.

Section 8: Baseball Operation



Sport Insert: LL-2605

Code: 03, 23

The sport insert drawing is located in **Appendix B**. If an insert is lost or damaged, a copy of the insert drawing can be used until a replacement arrives. Refer **Section 4.1** for information on starting the console and **Section 5.3** for additional All Sport application keys.

8.1 Baseball Keys

Home/Guest Score +1, -1

Display	Action
	Press the appropriate HOME or GUEST <SCORE +1> or <SCORE -1> key to increment or decrement the total number of runs for the team.
 NN = current setting	To manually change values, first press <EDIT> then either <SCORE +1> or <SCORE -1> to display the current setting. Enter the correct number using the keypad and press <ENTER> to save.

Out +1, Inning +1

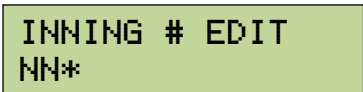
Display	Action
 NN = current setting	Press <OUT +1> or <INNING +1> to increment the total outs or innings, respectively. The numbers will immediately update on the LCD. To manually change values, first press <EDIT> then <OUT +1> or <INNING +1> to display the current setting. Enter the correct number using the keypad and press <ENTER> to save.

Ball, Strike, Clear Ball & Strike

- Press **<BALL +1>** or **<STRIKE +1>** to increment the ball and strike digits. The respective numbers will immediately update on the LCD.
- Press **<CLEAR BALL & STRIKE>** to clear the digits to zero.

Note: If the ball count value is 4 when **<BALL +1>** is pressed, the value is blanked out. If the strike count value is 3 when **<STRIKE +1>** is pressed, the value is blanked out.

Hit, Error

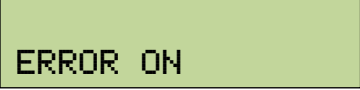
Display	Action
	Press the <HIT> or <ERROR> key to turn on the Hit or Error indicator or digits. The message at left will appear briefly.

Time, At Bat, H/E (Alternate Function)

The <TIME>, <AT BAT>, and <H/E> alternate function keys are used to select what is shown on the two time digits. First press the <ALT> key and then one of the above keys to select what is displayed on the two time digits. If <TIME> is selected, they will show two digits of time. If <AT BAT> is selected, they will show the player At Bat. If <H/E> is selected, they will show an 'H' or an 'E' on the first digit when <HIT> or <ERROR> is pressed.

Time/At Bat

If the controller is set to show the time, the <TIME/AT BAT •> key operates like the standard <SET TIME> key (refer to [Section 5.3](#)). If the controller is set to show AT BAT, it will operate as shown below.

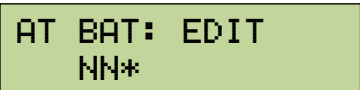
Display	Action
 NN = current setting	Press the <TIME/AT BAT •> key, enter the current batter number, and then press <ENTER>.

Section 9: Play Clock & Pitch Timer Operation

Sport Insert: LL-2653

Code: 05

The sport insert drawing is located in **Appendix B**. If an insert is lost or damaged, a copy of the insert drawing can be used until a replacement arrives. Refer **Section 4.1** for information on starting the console and **Section 5.3** for additional All Sport application keys.

9.1 Play Clock & Pitch Timer Keys

Set Reset 1, Set Reset 2

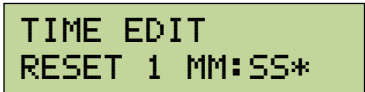
Display	Action
 MM:SS = minutes, seconds	Press <SET RESET 1 •> or <SET RESET 2 •> to set the current Reset 1 or Reset 2 value, respectively, for the play clock/pitch timer. To change the time, enter the desired value the using the number keys on the keypad and press <ENTER> .

Reset 1, Reset 2

- Press **<RESET 1>** to return the timer to the **Reset 1** value configured above.
- Press **<RESET 2>** to return the timer to the **Reset 2** value configured above.

For more information about play clock setups featuring server/client Base Stations, refer to **Drawing A-317837** in **Appendix A**.

Section 10: Segment Timer Operation

Sport Insert: LL-2613

Code: 06

The sport insert drawing is located in **Appendix B**. If an insert is lost or damaged, a copy of the insert drawing can be used until a replacement arrives. Refer **Section 4.1** for information on starting the console and **Section 5.3** for additional All Sport application keys.

10.1 Segment Timer Information

The segment timer is used to time events such as practice sessions. The operation of the segment timer is determined by 40 segments of pre-programmed length. The segment timer will count down starting at the segment number that is set as **First Segment**. When the first segment is completed, the segment timer will count the **Interval Time** and proceed with the next segment. The timer will continue counting segments until the segment number that is set as **Last Segment** is counted down. It then will reset to the segment saved as the **First Segment** and will either begin counting down or pause for the **<START>** key to be pressed, depending on the **Auto Stop At Last Seg** setting. To stop the timer after each segment is completed, use the **Auto Stop** feature.

The **First Segment** and **Last Segment** values can be used to set up specific practice sessions. For example, the practice session for one sport could be programmed to use segments 1-10, while another might use segments 11-20. Set the **First Segment** and **Last Segment** values to the desired segment numbers for the session, and the console will count down each of the segments in order, either stopping on the last segment or looping through included segments again, based on the **Auto Stop At Last Seg** setting.

The default **First Segment** value is 1. The default value for the **Last Segment** is 40.

10.2 Segment Timer Keys

First/Last Segment

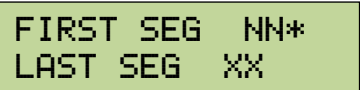
Display	Action
 <p>First/Last Segment display showing 'FIRST SEG NN*' and 'LAST SEG XX'. NN = current first segment XX = current last segment</p>	<p>Press the <FIRST/LAST SEGMENT> key. This setting determines the first and last segment in a range of segments to run when <START> is pressed.</p> <p>Enter the First Segment value and press <ENTER>.</p> <p>Enter the Last Segment and press <ENTER> to exit.</p> <p>The controller will be reset to the segment saved as First Segment when the <RESET TO 1ST SEGMENT> key is pressed.</p> <p>The controller automatically resets to the segment saved as First Segment after the segment saved as Last Segment is completed.</p>

Segment Number/Time

Display	Action
<pre>SEGMENT: NN TIME EDIT MM:SS*</pre>	<p>Press <SEG. NO. • TIME •> to set individual segment times.</p> <p>Enter the segment to be edited using the number keys on the keypad and press <ENTER>.</p>
<pre>SEGMENT: NN* TIME EDIT</pre> <p>NN = segment number MM:SS = minutes, seconds</p>	<p>Enter the time for the segment using the number keys on the keypad and press <ENTER> to accept the time and move to the next segment time.</p> <p>Press <ENTER> again to exit the function.</p>

Interval Time

The interval time is the time between each segment.

Display	Action
<pre>INTERVAL TIME: MM:SS*</pre> <p>MM:SS = minutes, seconds</p>	<p>Press <INTERVAL TIME •> to display the current value of interval time on the bottom line of the LCD. Enter the interval time using the number keys on the keypad and press <ENTER> to accept the time.</p> <p>If the interval time is set to 00:00, no interval time will be counted.</p>
<pre>DISPLAY INTERVAL 1-YES 2*NO</pre> <p>* = current setting</p>	<p>This setting determines whether the interval count will be displayed on the scoreboard.</p> <p>Press <1> to display the interval time on the scoreboard. Press <2> to disable interval time display. The interval time will be displayed only on the controller.</p> <p>Notes: Regardless of this setting, the value saved in interval time will be counted down between segments. Set the interval time to 0:00 if no interval between segments is desired.</p> <p>When the interval time is being displayed, the segment number on the scoreboard flashes to indicate that the time displayed is interval time.</p>

Copy Range

This key sets a range of segments to a specific time value.

Display	Action
<pre>COPY: MM:SS * SEG XX TO YY</pre> <p>MM:SS = minutes, seconds XX = starting segment value YY = ending segment value</p>	<p>Press <COPY RANGE >, enter the time to be copied using the number keys on the keypad, and then press <ENTER> to move to the next field.</p> <p>Enter the first and last segments that will have this time. When the last segment in the copy range is set, the menu will be exited.</p> <p>Once completed, all segments from XX to YY (inclusive) will be set to the specified time.</p>

Auto Stop

This key is the auto stop function of the console.

Note: To set the console to stop after the last segment in the series is completed, the auto stop at each segment setting must be set to **NO**.

Display	Action
<pre>STOP AT EACH SEG 1-YES 2*NO</pre> <p>* = current setting</p>	<p>Press <AUTO STOP> to enter this menu.</p> <p>Press <1> to set the controller to stop after each segment is completed and wait for the <START> key to proceed with the next segment.</p> <p>Press <2> to set the controller to automatically begin the next segment when each segment is completed. The controller will prompt for the auto stop at last segment setting:</p>
<pre>STOP AT LAST SEG 1*YES 2-NO</pre> <p>* = current setting</p>	<p>Press <1> to set the controller to stop when the last segment has been completed.</p> <p>Press <2> to set the controller to start over at the first segment when the last segment is completed.</p>

Warning Time

Display	Action
<div style="border: 1px solid black; background-color: #d9ead3; padding: 5px; margin-bottom: 5px;"> <p>WARNING TIME MM:SS*</p> </div> <p>MM:SS = minutes, seconds</p>	<p>Press <WARNING TIME >, enter the time in minutes and seconds and press <ENTER>.</p> <p>Enter 00:00 for no warning time (default).</p> <p>When the warning time is reached, the segment number flashes until the main clock reaches zero.</p>

Current Segment +1

Display	Action
<div style="border: 1px solid black; background-color: #d9ead3; padding: 5px; margin-bottom: 5px;"> <p>CURRENT SEGMENT: EDIT NN*</p> </div> <p>NN = current setting</p>	<p>Press <CURRENT SEGMENT +1> to increment the segment number. The segment number and segment time will immediately update on the LCD.</p> <p>To manually change values, first press <EDIT> then <CURRENT SEGMENT +1> to display the current setting. Enter the correct number using the keypad and press <ENTER> to save.</p>

Reset Current Segment

Press **<RESET CURRENT SEGMENT>** to reset the segment time to the value specified by the current segment. The segment number will remain at the current value.

Reset to First Segment

Press **<RESET TO FIRST SEGMENT>** to reset the segment number and segment time to the values saved as the first segment.

Note: The **Reset to First Segment** function is disabled while the clock is running.

Section 11: Tennis Operation

Sport Insert: LL-2607

Code: 08

The sport insert drawing is located in **Appendix B**. If an insert is lost or damaged, a copy of the insert drawing can be used until a replacement arrives. Refer **Section 4.1** for information on starting the console and **Section 5.3** for additional All Sport application keys.

11.1 Court Selection

Multiple wireless handheld controllers may be connected to a single wireless Base Station in the Tennis application. Each connected handheld controller will operate a specific court, and the controller number for the handheld is selected when powered up.

Display	Action
<div style="border: 1px solid black; background-color: #d9ead3; padding: 5px; margin-bottom: 5px;"> ENTER CONTROLLER NUMBER NN* </div> <p>NN = current setting</p>	<p>Enter the controller number for the court that this particular handheld will operate and then press <ENTER>.</p> <p>Typically, controller 1 would run court 1, controller 2 would run court 2, and so on. Some systems may be set up differently.</p>
<div style="border: 1px solid black; background-color: #d9ead3; padding: 5px; margin-bottom: 5px;"> ERROR - NUMBER TAKEN </div> <div style="border: 1px solid black; background-color: #d9ead3; padding: 5px;"> ERROR - INVALID NUMBER </div>	<ul style="list-style-type: none"> • If the controller number entered has already been selected, the error message at left will display. Select another number. • If the controller number entered is too high, the error message at left will display. Select another number.

11.2 Tennis Keys

Serve

Display	Action
<div style="border: 1px solid black; background-color: #d9ead3; padding: 5px;"> TOP SERVE ON </div>	<p>Press the appropriate TOP or BOTTOM <SERVE> key to turn the serve indicators ON or OFF for the respective player/team.</p>

Game +1

Display	Action
<pre>GAMES WON +1 SET X TOP Y</pre>	Press the appropriate TOP or BOTTOM <GAME +1> key to increment the number of games won in the current set for the respective player/team.
<pre>GAMES WON EDIT SET X TOP Y</pre> <p>X = current set Y = current games won</p>	To manually change values, first press <EDIT> then <GAME +1> to display the current setting. Enter the correct number using the keypad and press <ENTER> to save.

Point

Display	Action
	Press the appropriate TOP or BOTTOM <POINT> key to increment the total points for the respective player/team. The current point values will immediately update on the LCD. The points will increment as 15, 30, 40 AD or GA. If Tie Break scoring mode is selected, the points will increment by 1.
<pre>TOP=NN* BOT= EDIT TOP</pre> <p>NN = current setting</p>	To manually change values, first press <EDIT> then <POINT> to display the current setting. Enter the correct number using the keypad and press <ENTER> to save.

Reset Game

Press **<RESET GAME>** to reset the player points values for the current game.

Tie Break

Press **<TIE BREAK>** to set the mode of scoring to **Tie Break** mode. In **Tie Break** scoring mode, points for each player are incremented by one when the **<POINTS>** key is pressed.

Note: Tie Break scoring mode may only be selected when both player point values are 0. To change scoring mode back to normal, use the **<RESET GAME>** key.

TOD/Game

This key toggles the controller between displaying **Game Time** or **Time of Day (TOD)**. It also allows the user to change the time of day.

Display	Action
<pre>SET TIME OF DAY 12HR HH:MM:SS*</pre> <p>HH:MM:SS = hours, mins, secs</p>	<p>Press <TOD/GAME> to set the Time of Day. Enter the correct number using the keypad and press <ENTER> to save. The time of day clock is now displayed, if the scoreboard has that capability.</p>

Set +1

Display	Action
<pre>SET EDIT NN</pre> <p>NN = current setting</p>	<p>Press <SET +1> to increment the current set number. The new set number and games won values will immediately update on the LCD.</p> <p>To manually change values, first press <EDIT> then <SET +1> to display the current setting. Enter the correct number using the keypad and press <ENTER> to save.</p>
<pre>INVALID SET PLEASE RE-ENTER</pre>	<p>If the set number entered is invalid, the error message at left will display. Enter another set number.</p>

Matches Won (Alternate Function)

Display	Action
<pre>MATCHES WON EDIT TOP NN*</pre>	<p>Press <ALT> and then the appropriate TOP or BOTTOM <MATCHES WON> key to edit the matches won for the respective player/team. Enter the correct number using the keypad and press <ENTER> to save.</p>

Reset Match (Alternate Function)

Display	Action
<pre>PRESS ENT TO START NEW MATCH</pre>	<p>Press <ALT> and then <RESET MATCH>. Press <ENTER> to confirm resetting the current match.</p> <p>All set scores and the current game score will be cleared, and the set number will be set to 1.</p>

Next Match (Alternate Function – DakTennis Only)

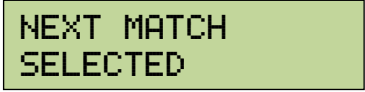
Display	Action
	Press <ALT> and then <NEXT MATCH> to tell the DakTennis™ software to switch to the next match. The LCD will show that the next match was selected.

Winner (Alternate Function – DakTennis Only)

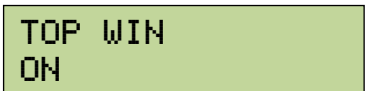
Display	Action
	Press <ALT> and then <WINNER> for the respective TOP or BOTTOM player to tell the DakTennis™ software to set the player as the winner if currently off or clear the winner if currently on. The LCD will show the status of the winner being set ON or OFF.

For more information, refer to the **DakTennis Version 3 Installation & Operation Manual (DD1965926)**, available online at www.daktronics.com/manuals.

Section 12: Sand Volleyball Operation

Sport Insert: LL-2607

Code: 09

The sport insert drawing is located in **Appendix B**. If an insert is lost or damaged, a copy of the insert drawing can be used until a replacement arrives. Refer **Section 4.1** for information on starting the console and **Section 5.3** for additional All Sport application keys.

12.1 Court Selection

Multiple wireless handheld controllers may be connected to a single wireless Base Station in the Sand Volleyball application. Each connected handheld controller will operate a specific court, and the controller number for the handheld is selected when powered up.

Display	Action
<div style="border: 1px solid black; background-color: #d4edda; padding: 5px; margin-bottom: 5px;"> <p>ENTER CONTROLLER NUMBER NN*</p> </div> <p>NN = current setting</p>	<p>Enter the controller number for the court that this particular handheld will operate and then press <ENTER>.</p> <p>Typically, controller 1 would run court 1, controller 2 would run court 2, and so on. Some systems may be set up differently.</p>
<div style="border: 1px solid black; background-color: #d4edda; padding: 5px; margin-bottom: 5px;"> <p>ERROR - NUMBER TAKEN</p> </div> <div style="border: 1px solid black; background-color: #d4edda; padding: 5px;"> <p>ERROR - INVALID NUMBER</p> </div>	<ul style="list-style-type: none"> • If the controller number entered has already been selected, the error message at left will display. Select another number. • If the controller number entered is too high, the error message at left will display. Select another number.

12.2 Sand Volleyball Keys

Note: On the sport insert and LCD, "TOP" = HOME and "BOT" = GUEST on a scoreboard.

Serve

Display	Action
<div style="border: 1px solid black; background-color: #d4edda; padding: 5px;"> <p>TOP SERVE ON</p> </div>	<p>Press the appropriate TOP or BOTTOM <SERVE> key to turn the serve indicators ON or OFF for the respective team.</p>

Point

Display	Action
<pre>TOP= 1 SET BOT= 0 1</pre>	<p>Press the appropriate TOP or BOTTOM <POINT> key to increment the total points for the respective team in the currently selected set. The current point values will immediately update on the LCD. The points will increment by 1.</p>
<pre>SCORE EDIT TOP NN*</pre> <p>NN = current setting</p>	<p>To manually change values, first press <EDIT> then <POINT> to display the current setting. Enter the correct number using the keypad and press <ENTER> to save.</p>

Set +1

Display	Action
<pre>TOP=21 0 SET BOT=18 0 2</pre>	<p>Press <SET +1> to increment the current set number. The new set number will immediately update on the LCD. The scores will be set to 0 for each team, if they do not already have points entered for the set.</p>
<pre>SET EDIT NN</pre> <p>NN = current setting</p>	<p>To manually change values, first press <EDIT> then <SET +1> to display the current setting. Enter the desired number using the keypad and press <ENTER> to save. After selecting a previous set number, use the <POINT> keys to edit that set's scores.</p>
<pre>INVALID SET PLEASE RE-ENTER</pre>	<p>If the set number entered is invalid, the error message at left will display. Enter another set number.</p>

Reset Game/Reset Match

Display	Action
<pre>PRESS ENT TO START NEW MATCH</pre>	<p>Press <RESET GAME> followed by <ENTER> to confirm resetting the current match. This is typically performed after completion of the final set.</p> <p>All scores will be cleared, and the Set number will go back to 1.</p>

TOD/Game

This key toggles the controller between displaying **Game Time** or **Time of Day (TOD)**. It also allows the user to change the time of day.

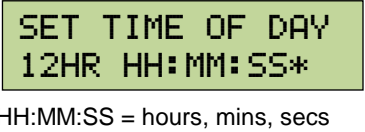
Display	Action
 <p>SET TIME OF DAY 12HR HH:MM:SS* HH:MM:SS = hours, mins, secs</p>	Press <TOD/GAME> to set the Time of Day. Enter the correct number using the keypad and press <ENTER> to save. The time of day clock is now displayed, if the scoreboard has that capability.

Matches Won (Alternate Function)

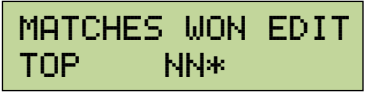
Display	Action
 <p>MATCHES WON EDIT TOP NN*</p>	Press <ALT> and then the appropriate TOP or BOTTOM <MATCHES WON> key to edit the matches won for the respective team. Enter the correct number using the keypad and press <ENTER> to save.

Game +1, Tie Break, Next Match, Winner

These keys are not used for Sand Volleyball mode.

Section 13: Basketball Operation

Sport Insert: LL-2632

Code: 10 (Use Code 20 for optimized server/client operation.)

The sport insert drawing is located in **Appendix B**. If an insert is lost or damaged, a copy of the insert drawing can be used until a replacement arrives. Refer **Section 4.1** for information on starting the console and **Section 5.3** for additional All Sport application keys.

13.1 Basketball Keys

Home/Guest Score +1, +2, (+3, -1)

Display	Action
<pre>HOME SCORE + 1 NNN</pre>	Press the appropriate HOME or GUEST <SCORE +1> or <SCORE +2> key to increment the total number of points for the respective team by the value on the key.
<pre>HOME SCORE + 3 NNN</pre>	To increment the score by 3, press <ALT> and then <SCORE +3> .
<pre>HOME SCORE - 1 NNN</pre>	To decrement the score by 1, press <ALT> and then <SCORE -1> .
<pre>HOME SCORE EDIT NNN*</pre> <p>NNN = current setting</p>	To manually change values, first press <EDIT> then any <SCORE> key to display the current setting. Enter the correct number using the keypad and press <ENTER> to save.

Fouls +1

Display	Action
<pre>HOME FOULS + 1 NN</pre>	Press the appropriate HOME or GUEST <FOULS +1> key to increment the fouls value for the respective team.
<pre>HOME FOULS EDIT NN*</pre> <p>NN = current setting</p>	To manually change values, first press <EDIT> then <FOULS +1> to display the current setting. Enter the correct number using the keypad and press <ENTER> to save.

Possession

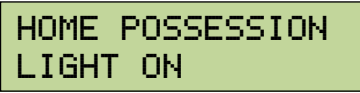
Display	Action
	Press <POSS> to light the appropriate indicator. Each press will turn on the opposite team's possession light.

Period +1

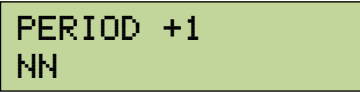
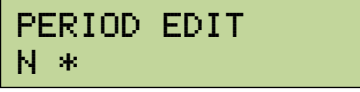
Display	Action
	Press <PERIOD +1> to increment the current period number.
 <p>NN = current setting</p>	To manually change values, first press <EDIT> then <PERIOD +1> to display the current setting. Enter the correct number using the keypad and press <ENTER> to save.

Set TOD (Alternate Function)

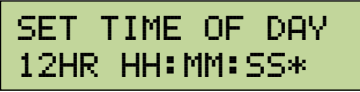
Display	Action
 <p>HH:MM:SS = hours, mins, secs</p>	Press <ALT> followed by <SET TOD> to set the Time of Day. Enter the correct number using the keypad and press <ENTER> to save. The time of day clock is now displayed, if the scoreboard has that capability.

1/10 SEC (Alternate Function)

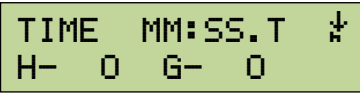
Display	Action
 <p>MM:SS.T = minutes, seconds, tenths of a second</p>	Press <ALT> followed by <1/10 SEC> to toggle the 1/10 second setting of the clock. The clock on the LCD will show time to tenths of a second.

Bonus (Alternate Function)

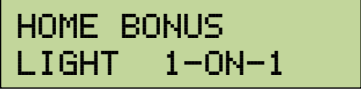
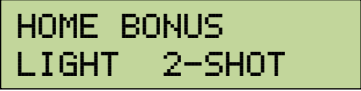
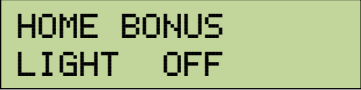
Display	Action
	Press <ALT> followed by the appropriate HOME or GUEST <BONUS> key to turn on the 1-ON-1 bonus light.
	Press <ALT> followed by the same <BONUS> key a second time to turn on the 2 SHOT bonus light.
	Press <ALT> followed by the same <BONUS> key a third time to turn on the bonus light OFF.

Section 14: Football Operation



Sport Insert: 0G-1031603

Code: 61, 62

The sport insert drawing is located in **Appendix B**. If an insert is lost or damaged, a copy of the insert drawing can be used until a replacement arrives. Refer **Section 4.1** for information on starting the console and **Section 5.3** for additional All Sport application keys.

14.1 Football Keys

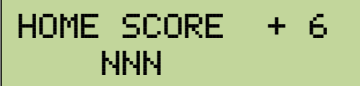
Home/Guest Score +1, +6, (+3, -1)

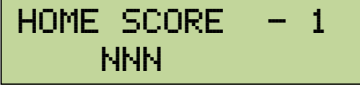
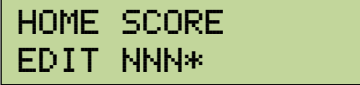
Display	Action
 <pre>HOME SCORE + 6 NNN</pre>	Press the appropriate HOME or GUEST <SCORE +1> or <SCORE +6> key to increment the total number of points for the respective team by the value on the key.
 <pre>HOME SCORE + 3 NNN</pre>	To increment the score by 3, press <ALT> and then <SCORE +3> .
 <pre>HOME SCORE - 1 NNN</pre>	To decrement the score by 1, press <ALT> and then <SCORE -1> .
 <pre>HOME SCORE EDIT NNN*</pre> <p>NNN = current setting</p>	To manually change values, first press <EDIT> then any <SCORE> key to display the current setting. Enter the correct number using the keypad and press <ENTER> to save.

Ball On

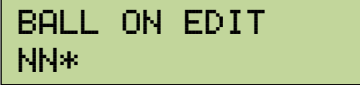
Display	Action
 <pre>BALL ON EDIT NN*</pre> <p>NN = current setting</p>	Press <BALL ON •> to set the yard line of the ball. Enter the correct number using the keypad and press <ENTER> to save.

Down +1

Display	Action
<pre>DOWN +1 N</pre>	Press the <DOWN +1> key to increment the down number. The value increments from 1 to 4 then repeats.
<pre>DOWN EDIT N*</pre> <p>N = current setting</p>	To manually change values, first press <EDIT> then <DOWN +1> to display the current setting. Enter the correct number using the keypad and press <ENTER> to save.

TOL -1

Display	Action
<pre>HOME TOL - 1 N</pre>	Press the appropriate HOME or GUEST <TOL -1> to decrement the number of Time Outs Left (TOL) for the respective team. By default, each team starts the game with 3 time outs.
<pre>HOME TOL EDIT N*</pre> <p>N = current setting</p>	To manually change values, first press <EDIT> then <TOL -1> to display the current setting. Enter the correct number using the keypad and press <ENTER> to save.

To Go

Display	Action
<pre>TO GO EDIT NN*</pre> <p>NN = current setting</p>	Press <TO GO •> to set the distance to go until first down. Enter the correct number using the keypad and press <ENTER> to save.

Possession (Alternate Function)

Display	Action
<pre>HOME POSS LIGHT ON</pre>	Press <ALT> followed by the appropriate HOME or GUEST <POSS> key to light the possession indicator for the respective team. A second press will turn the indicator off, as will turning on the opposing team's indicator.

QTR +1

Display	Action
<pre>QUARTER +1 N</pre>	Press <QTR +1> to increment the current quarter number.
<pre>QUARTER EDIT N *</pre> <p>N = current setting</p>	To manually change values, first press <EDIT> then <QTR +1> to display the current setting. Enter the correct number using the keypad and press <ENTER> to save.

Section 15: Remote Start/Stop Operation

Sport Insert: 0G-319079

Code: 98

The sport insert drawing is located in **Appendix B**. If an insert is lost or damaged, a copy of the insert drawing can be used until a replacement arrives. Refer **Section 4.1** for information on starting the console and **Section 5.3** for additional All Sport application keys.

15.1 Remote Start/Stop Keys

Start

Display	Action
<pre>REM START/STOP CLOCK OFF</pre>	When the clock is stopped, the LCD will show the clock status on the bottom line as OFF.
<pre>CLOCK START CLOCK RUN</pre>	Press <START> and the top line of the LCD will briefly show the function, and then the clock status will change to RUN.

Stop

Display	Action
<pre>REM START/STOP CLOCK RUN</pre>	When the clock is already running, the LCD will show the clock status on the bottom line as RUN.
<pre>CLOCK STOP CLOCK OFF</pre>	Press <STOP> and the top line of the LCD will briefly show the function, and then the clock status will change back to OFF.

Manual Horn/Reset

Depending on the current jack the Base Station is connected to on the All Sport 5000 controller, this key will have different functions:

- When connected to the J4 (main clock) jack, the key functions as a manual horn.
- When connected to the J7 (shot/play clock) jack, the key functions as a timer reset.

For more information about Remote Start/Stop setups, refer to **Drawing B-319037** in **Appendix A**.

Section 16: Goal Judge Operation

Sport Insert: LL-2663

Code: 99

The sport insert drawing is located in **Appendix B**. If an insert is lost or damaged, a copy of the insert drawing can be used until a replacement arrives. Refer **Section 4.1** for information on starting the console and **Section 5.3** for additional All Sport application keys.

Note: When using the RC-100 as a Goal Judge console, operators should disable the auto power off setting (Power Save Mode). Refer to **Section 4.4**.

16.1 Goal Judge Keys

Goal Light On/Off

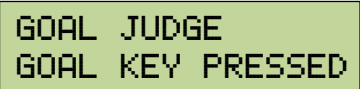
Display	Action
	Press <GOAL LIGHT ON/OFF> to turn the goal lights ON if they are off, or OFF if they are already on.

For more information about goal judge setups, refer to **Drawing A-317405** in **Appendix A**.

Section 17: CAN Handheld Operation

This section describes operation details specific to CAN (Controller Area Network) handheld operations. CAN handheld functionality is used when handheld operation is controlled by a device on the CAN network such as the OmniSport 2000 timing console. Refer to **Drawing A-230608** in **Appendix A** for typical CAN setup information.

17.1 Common CAN Handheld Operation

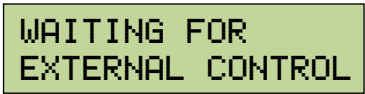
Display	Action
	<p>When the message at left is shown on the LCD, the Base Station is waiting to be connected to an external device on the CAN network.</p> <p>When a CAN device is detected, the LCD will update to show application-specific information.</p>

17.2 Diving & Synchronized Swimming Operations

Sport Insert: LL-2606

Refer to the Judge's Console section of the **OmniSport 2000 Timing Console Operations Manual (ED-13312)** for application-specific operation instructions.

17.3 Rodeo Operations

Sport Insert: LL-2608

Refer to the Judge's Console section of the **OmniSport 2000 Rodeo Timer Operations Manual (ED-14843)** for application-specific operation instructions.

Section 18: Troubleshooting

18.1 Handheld Controller Error Messages

Display	Cause/Solution
<div data-bbox="354 472 711 562" style="border: 1px solid black; background-color: #d9ead3; padding: 5px; margin-bottom: 10px;"> NO SERVER FOUND ON CHANNEL NN </div> <p data-bbox="354 577 568 609">NN = current setting</p> <div data-bbox="354 751 711 842" style="border: 1px solid black; background-color: #d9ead3; padding: 5px; margin-top: 10px;"> ENT TO RETRY CLEAR SETS CHAN </div>	<p data-bbox="743 462 1356 525">The wireless handheld could not find a server on the specified channel.</p> <ul data-bbox="787 556 1404 955" style="list-style-type: none"> • Make sure the wireless Base Station is powered on, and is set for the specified channel. • Make sure the handheld is within minimum and maximum range limits (refer to Section 2). • Press <ENTER> to retry the connection (if the handheld was just moved in range or the wireless Base Station has been correctly configured). • Press <CLEAR> to set the channel number to a different channel and retry.
<div data-bbox="354 1024 711 1115" style="border: 1px solid black; background-color: #d9ead3; padding: 5px; margin-bottom: 10px;"> NO RESPONSE ON CHANNEL NN </div> <p data-bbox="354 1129 568 1161">NN = current setting</p> <div data-bbox="354 1423 711 1514" style="border: 1px solid black; background-color: #d9ead3; padding: 5px; margin-top: 10px;"> ENT TO RETRY CLEAR SETS CHAN </div>	<p data-bbox="743 1014 1396 1077">The wireless handheld <i>did</i> find a server on the specified channel, but the server did not respond.</p> <ul data-bbox="787 1108 1404 1633" style="list-style-type: none"> • Make sure the handheld is within minimum and maximum range limits (refer to Section 2). • Cycle power to the wireless Base Station and retry the connection. • Make sure that there are no other wireless Base Stations within range on the same channel. Try a different channel if necessary. • Press <ENTER> to retry the connection (if the handheld was just moved in range or the wireless Base Station has been correctly configured). • Press <CLEAR> to set the channel number to a different channel and retry.
<div data-bbox="354 1705 711 1795" style="border: 1px solid black; background-color: #d9ead3; padding: 5px;"> ERROR - THIS CHANNEL IN USE </div>	<p data-bbox="743 1705 1372 1837">The message at left is displayed if another wireless handheld controller is currently connected to the Base Station and the application does not permit multiple handheld units.</p> <p data-bbox="743 1869 1339 1927">Power off any other unused handheld units on the same channel in the area (refer to Section 4.1).</p>

Display	Cause/Solution
	<p>Although multiple wireless handheld controllers may be connected to a single Base Station, the following applications allow only one handheld device to be connected at a time:</p> <ul style="list-style-type: none"> • Baseball • Basketball • Clock/Score • Football • Goal Judge • Play Clock/Pitch Timer • Remote Start/Stop • Segment Timer • Volleyball
<div style="border: 1px solid black; background-color: #d4edda; padding: 5px; margin-bottom: 10px;"> <p>LOW SIGNAL STRENGTH</p> </div> <div style="border: 1px solid black; background-color: #d4edda; padding: 5px;"> <p>PRESS CLEAR FOR CONFIG MENU</p> </div>	<p>The Base Station has stopped responding to the wireless handheld. This could mean any of the following scenarios are true:</p> <ul style="list-style-type: none"> • The Base Station was turned off or has lost power. • The Base Station was changed to a different channel. • The Base Station and handheld are too far away or too close (refer to Section 2). <p>If all of these problems have been checked and the handheld still shows Low Signal Strength, cycle power on both the handheld and Base Station.</p>

18.2 Base Station Errors

IN RANGE LED On Start-up

The IN RANGE LED (**Figure 10**) flashes several times at start-up while the server Base Station searches for other Base Stations on the same channel within range. If another server Base Station is found, this LED will flash continuously, indicating that only one server Base Station is allowed on a given channel.

General Base Station Failures

The wireless Base Station uses the on-board LEDs (**Figure 10**) to indicate failure status. When a failure occurs, the CL/RS232 TX, CL/RS232 RX, IN RANGE, and CAN TX LEDs all flash in a repetitive pattern to indicate the failure type. The LEDs will flash on for a long period of time, followed by a series of short flashes that give the error type. This sequence will repeat 5 times, after which the Base Station will reset.

If an error sequence is being displayed on the LEDs, first cycle power to the wireless Base Station by disconnecting power for several seconds and then reconnecting. If the problem persists, please contact Daktronics Customer Service (refer to **Section 1.2**).

Obtaining Base Station Status Information

When connected to a wireless Base Station in any All Sport function, the wireless handheld can obtain status information about the Base Station. This information includes the Base Station channel, firmware revision number and date, and whether or not the Base Station is synchronized to another Base Station in the area.

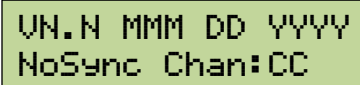
Display	Action
 <p>UN.N MMM DD YYYY NoSync Chan:CC</p> <p>N.N = firmware revision MMM = month DD = date YYYY = year CC = channel number</p>	<p>Press <ALT> followed by <CONNECT> to display Base Station status information.</p> <p>Press any key to return to normal operation.</p> <p>Note: If the Base Station is synchronized to another Base Station via a sync group, the bottom left corner of the LCD will display "Sync:" followed by the sync group number. Refer to Section 3.3.</p>

18.3 Replacing Handheld Battery

To verify the battery is replaceable, look at the assembly number (ASSY NO.) and revision number (REV) on the back of the unit (**Figure 28**).

- If the assembly number is **0A-1110-0033** and the revision number is **REV 7** or higher (after August 30, 2007), the battery may be replaced in the field. Units built before this date must be sent to Daktronics to install a new battery.
- If the assembly number is **0A-1110-0053**, the battery may be replaced in the field regardless of revision number.



Figure 28: Manufacturing Date & Revision Number

After verifying the correct numbers, follow the steps below to replace the battery.

1. Remove the two Philips screws (one on the top and one on the bottom) to separate the bottom half of the case from the top half.
2. Disconnect the 2-pin battery power cable from the main circuit board, and remove the battery from the retaining clips (**Figure 29**).
3. Install new battery (Daktronics part # BT-1032) into the retaining clips, and connect the 2-pin cable.
4. Close the case, and replace the two screws.
5. Charge the battery as needed before first use.

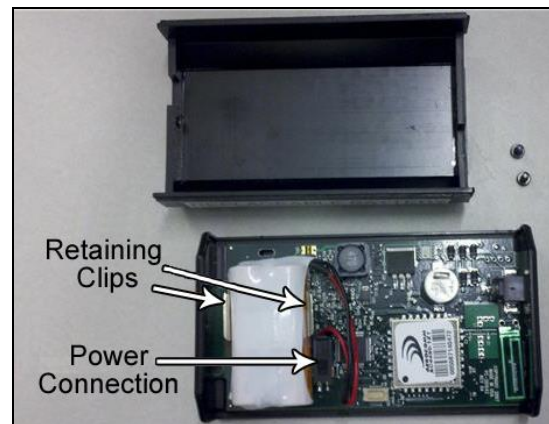

Figure 29: Handheld Unit, Cover Removed

Note: Please return used batteries to a battery recycling center or retailer for disposal.

Appendix A: Reference Drawings

<i>Drawing Title</i>	<i>Drawing Number</i>
Base Station: Indoor Installation	A-227465
System Riser Diagram; RC-100, Baseball/Tennis	A-230530
System Riser; RC-100, Rodeo/Diving/Sync Swimming	A-230608
System Riser; Tennis; Indoor Multi-Court, DakTennis, CG	B-231298
Charging Station, Specifications & Operation	A-231674
System Riser; Tennis; Multi-Court, RC-100 Direct	B-233254
Base Station: Outdoor Installation	A-236394
System Riser Diagram; DakTennis, Video Control	A-251996
System Riser; Tennis; Indoor/Outdoor Single Court, RC-100	A-252412
Base Station: DistaView Scoreboard Installation	A-266717
System Riser; Tennis; Outdoor Multi-Court DakTennis, CG	B-281236
Riser Diagram; Goal Indicator System w/ RC 100	A-317405
System Riser Diagram; RC-100 Server/Client Line	A-317837
System Riser, RC-100 Game/DOG Clock Remote St/St	B-319037
System Riser; Tennis; DakTennis & Remote Base Station	A-1040167
System Riser; Tennis. Multi-Court, DakTennis, Radio, CG	B-1077063

TOP VIEW

STEP 1 CHART

FUNCTION SETTING	FUNCTION (SERVER MODE)
0	DEFAULT FUNCTION (LAST POWER UP FUNCTION)
1	CAN HANDHELD JUDGES CONSOLE
2	ALL SPORT SCBD CONTROLLER - GEN I
3	DATA TIME MASTER DISPLAY CONTROLLER
5	ALL SPORT SCBD CONTROLLER - GEN II
F	RESET MEMORY/TEST
4, 6-E	RESERVED

STEP 1
 USING A SMALL FLAT HEAD SCREW DRIVER OR YOUR FINGERS CHANGE THE SWITCHES TO THE DESIRED CHANNEL AND FUNCTION NUMBER. (REFER TO STEP 1 VIEW AND CHART FOR CHANNEL SELECTION.)
STEP 2
 NOTE THE CHANNEL NUMBER SET FOR THIS UNIT.
STEP 3
 BASE STATION IS SET IN FACTORY FOR SERVER MODE. FOR CLIENT MODE, SET JUMPERS TO RIGHT MOST POSITION.

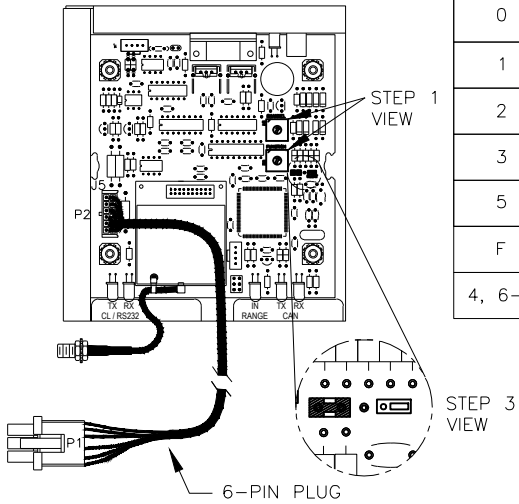

BASE STATION MOUNTING IN MOST INDOOR SCOREBOARDS. SEE DWG-1130990 FOR BASE STATION MOUNTING IN SCOREBOARDS MADE AFTER MARCH 2013

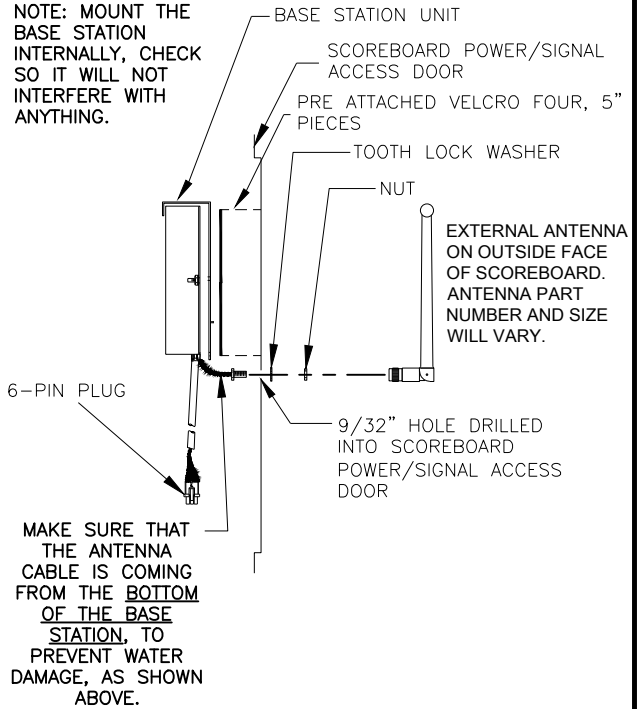

GYRUS VIEW

PLUG THE 6-PIN MALE PLUG FROM THE BASE STATION INTO THE MATING 6-PIN JACK (J21) ON THE DRIVER PCB AS SHOWN.

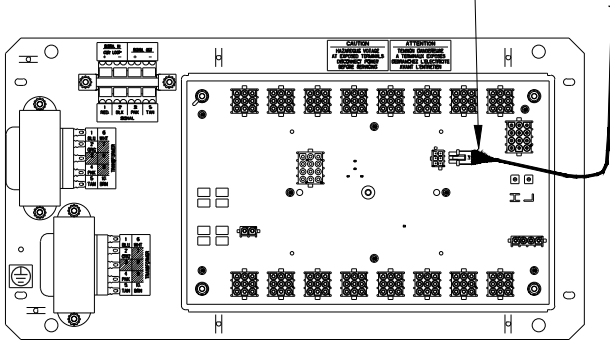

LEGACY VIEW

(BUILT PRIOR TO APRIL 2015)

WHEN REPLACING BASE STATION 0A-1110-0035 USE THE ORIGINAL CABLE IN PLACE OF W-2909. SEE VIEWS FOR DETAILS.

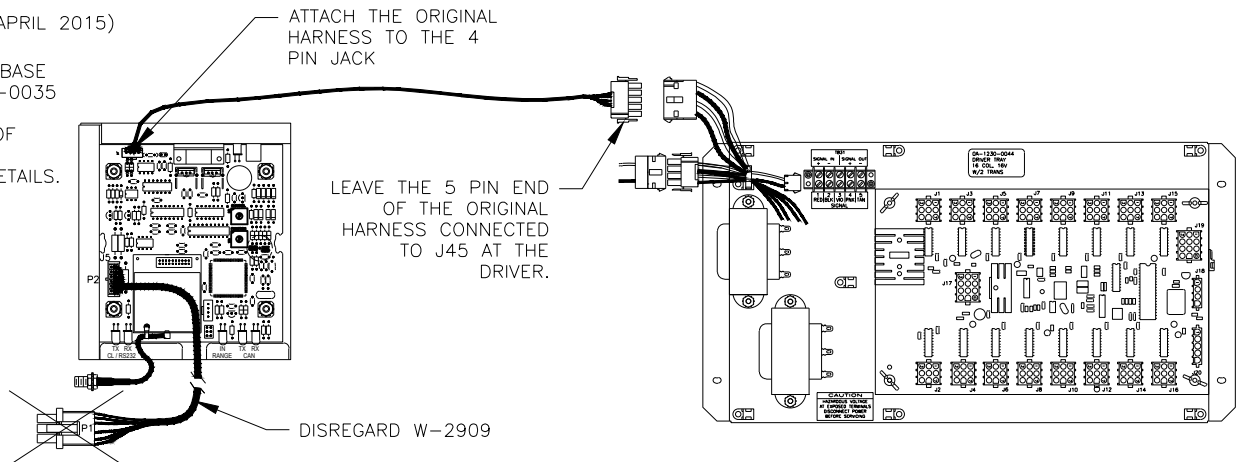

REV	DATE	DESCRIPTION	BY
05	26 JAN 16	ROTATED GYRUS DRIVER 180 DEGREES	MTR
04	17 FEB 15	UPDATED VIEWS TO INCLUDE NEW GYRUS DIGIT DRIVER AND ADAPTER HARNESS	BJG
03	24 AUG 11	UPDATED FUNCTION CHART AND TITLE BLOCK	JUL
02	18 JUN 08	ADDED STEP 1.4 AND DETAIL	AMG
01	02 MAR 05	UPDATED DRAWING FOR NEW REV METAL PARTS	DJU

DAKTRONICS, INC. BROOKINGS, SD 57006	THE CONCEPTS EXPRESSED AND DETAILS SHOWN ON THIS DRAWING ARE CONFIDENTIAL AND PROPRIETARY. DO NOT REPRODUCE BY ANY MEANS WITHOUT THE EXPRESSED WRITTEN CONSENT OF DAKTRONICS, INC. COPYRIGHT 2011 DAKTRONICS, INC.	
	DO NOT SCALE DRAWING	
Proj: RC-100		
TITLE: BASE STATION: INDOOR INSTALLATION		
DESIGN:	DRAWN: DULSCHM	DATE: 11 NOV 04
SCALE: 1 = 7		
SHEET	REV	JOB NO:
	05	P1110
FUNC-TYPE-SIZE		227465
E-07-A		

NOTE: THIS DETAIL SHOWS A BA-515. ACTUAL RC-100 SCOREBOARD RECEIVER BASE STATION MAY BE IN A DIFFERENT LOCATION DEPENDING ON DISPLAY TYPE.

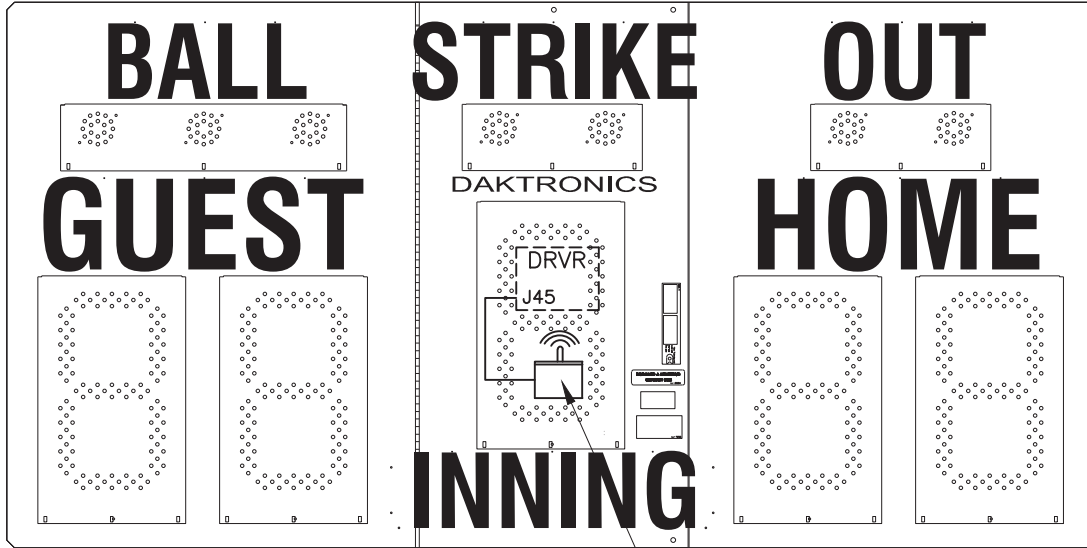

0A-1110-0035
FUNCTION SETTING = 5

NOTE: RC-100 SCOREBOARD RECEIVER BASE STATION IS LOCATED BEHIND THE FRONT ACCESS PANEL OF DISPLAY.

NOTE: THE WIRELESS BASE STATION COMES PRE-SET TO CHANNEL 1. HOWEVER, CHANNELS 1-15 CAN BE USED.

FUNCTION TABLE

FUNCTION NUMBER	DESCRIPTION
0	DEFAULT FUNCTION (LAST POWER UP FUNCTION)
1	CAN HAND HELD (JUDGES) CONSOLE
2	BASEBALL/TENNIS SCOREBOARD CONTROLLER GEN I (ALLSPORT)
3	DATETIME/DATAMASTER DISPLAY CONTROL
5	BASEBALL/TENNIS SCOREBOARD CONTROLLER GEN II (ALLSPORT)

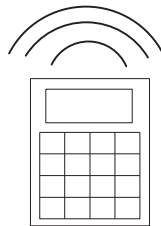

0A-1110-0053
INSERT: LL-2605 (BASEBALL) CODE 03
INSERT: LL-2607 (TENNIS) CODE 08

	DAKTRONICS, INC. BROOKINGS, SD 57006	THE CONCEPTS EXPRESSED AND DETAILS SHOWN ON THIS DRAWING ARE CONFIDENTIAL AND PROPRIETARY. DO NOT REPRODUCE BY ANY MEANS WITHOUT THE EXPRESSED WRITTEN CONSENT OF DAKTRONICS, INC. COPYRIGHT 2012 DAKTRONICS, INC.
	DO NOT SCALE DRAWING	

REV 03	DATE: 27 APR 12	UPDATED RC-100 HANDHELD PART NUMBER UPDATED BOARDER AND TITLE BLOCK	BY: JFL	
02	15 JAN 07	ADDED FUNCTION 5 GEN II	JRA	JRA
01	18 JUL 05	MODIFIED TEXT	CMG	

PROJ: RADIO LINK				
TITLE: SYSTEM RISER DIAGRAM: RC-100- BASEBALL/TENNIS				
DESIGN:		DRAWN: RTAGTOW		DATE: 29 DEC 04
SCALE: NONE				
SHEET	REV	JOB NO:	FUNC-TYPE-SIZE	230530
	03	P 1110	R - 01 - A	

SYNCHRONIZED SWIMMING



OA-1110-0053
DIVING INSERT: LL-2606
RODEO INSERT: LL-2608



OA-1110-0053
DIVING INSERT: LL-2606
RODEO INSERT: LL-2608



OA-1110-0053
DIVING INSERT: LL-2606
RODEO INSERT: LL-2608



OA-1110-0053
DIVING INSERT: LL-2606
RODEO INSERT: LL-2608

NOTE:

UP TO 18 RC-100 CONTROLLERS CAN BE USED AT ONCE (9 RC-100 CONTROLLERS PER BASE STATION).

CHANNELS 1-15 CAN BE USED, HOWEVER THE TWO BASE STATIONS MUST BE SET TO DIFFERENT CHANNELS. EACH BASE STATION AND ITS RESPECTIVE RC-100 CONTROLLERS NEED TO BE SET TO THE SAME CHANNEL.

FUNCTION TABLE

FUNCTION NUMBER	DESCRIPTION
0	DEFAULT FUNCTION (LAST POWER UP FUNCTION)
1	CAN HAND HELD (JUDGES) CONSOLE
2	BASEBALL/TENNIS SCOREBOARD CONTROLLER GEN I (ALLSPORT)
3	DATATIME/DATAMASTER DISPLAY CONTROL
5	BASEBALL/TENNIS SCOREBOARD CONTROLLER GEN II (ALLSPORT)

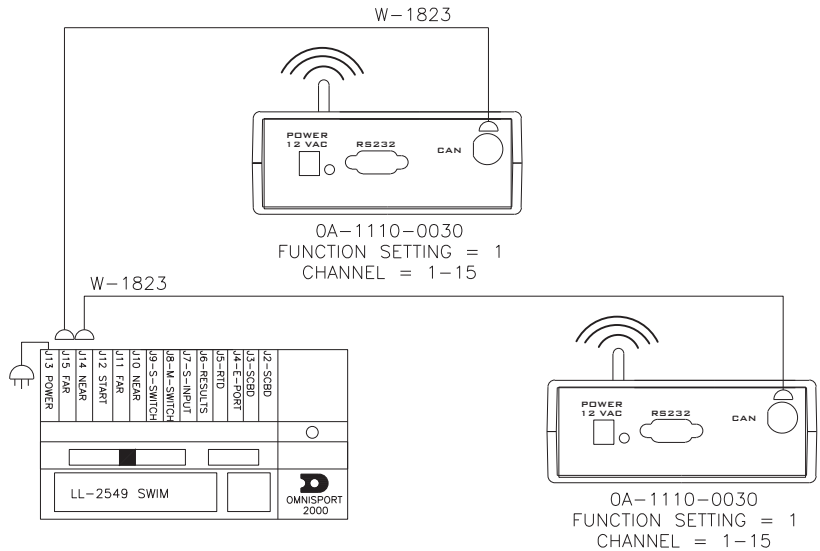

DIVING/RODEO

FUNCTION TABLE

FUNCTION NUMBER	DESCRIPTION
0	DEFAULT FUNCTION (LAST POWER UP FUNCTION)
1	CAN HAND HELD (JUDGES) CONSOLE
2	BASEBALL/TENNIS SCOREBOARD CONTROLLER GEN I (ALLSPORT)
3	DATATIME/DATAMASTER DISPLAY CONTROL
5	BASEBALL/TENNIS SCOREBOARD CONTROLLER GEN II (ALLSPORT)

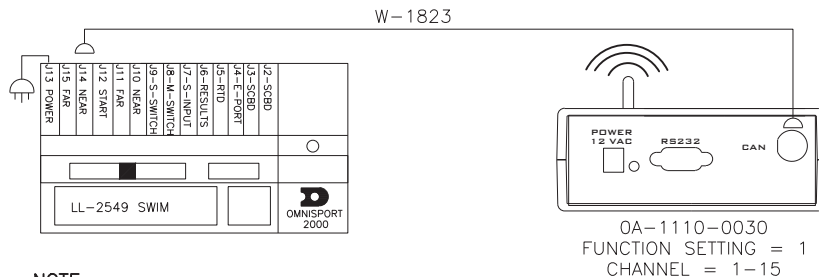

NOTE:

UP TO 9 RC-100 CONTROLLERS CAN BE USED AT ONCE.

CHANNELS 1-15 CAN BE USED, HOWEVER THE BASE STATION AND ALL RC-100 CONTROLLERS MUST BE OPERATING ON THE SAME CHANNEL.



OA-1110-0053
DIVING INSERT: LL-2606
RODEO INSERT: LL-2608



OA-1110-0053
DIVING INSERT: LL-2606
RODEO INSERT: LL-2608



OA-1110-0053
DIVING INSERT: LL-2606
RODEO INSERT: LL-2608



OA-1110-0053
DIVING INSERT: LL-2606
RODEO INSERT: LL-2608

DAKTRONICS, INC. BROOKINGS, SD 57006 DO NOT SCALE DRAWING	THE CONCEPTS EXPRESSED AND DETAILS SHOWN ON THIS DRAWING ARE CONFIDENTIAL AND PROPRIETARY. DO NOT REPRODUCE BY ANY MEANS WITHOUT THE EXPRESSED WRITTEN CONSENT OF DAKTRONICS, INC. COPYRIGHT 2012 DAKTRONICS, INC.	
	PROJ: RADIO LINK TITLE: SYSTEM RISER: RC-100- RODEO/DIVING/SYNC SWIMMING	
DESIGN:	DRAWN: RTAGTOW	DATE: 30 DEC 04
SCALE: NONE		
SHEET	REV	JOB NO:
01	02	P 1110
FUNC-TYPE-SIZE		230608
R-01-A		

REV 02	DATE: 27 APR 12	UPDATED RC-100 HANDHELD PART NUMBER UPDATED BOARDER AND TITLE BLOCK	BY: JFL	
01	15 JAN 07	FUNCTION 5 GEN II	JRA	JRA

INDOOR SCOREBOARD LAYOUT
REFER TO MANUAL FOR ALL POWER, SIGNAL AND
INSTALLATION DETAILS.

REAR VIEW

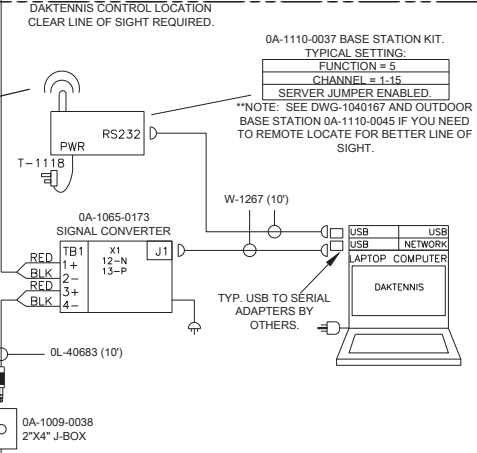
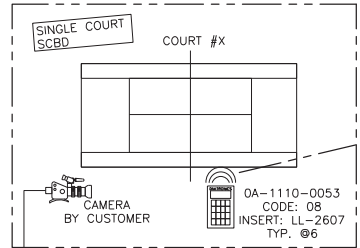
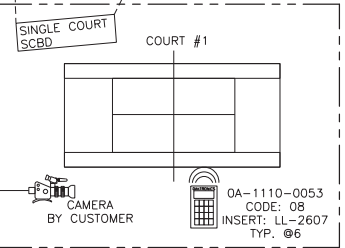
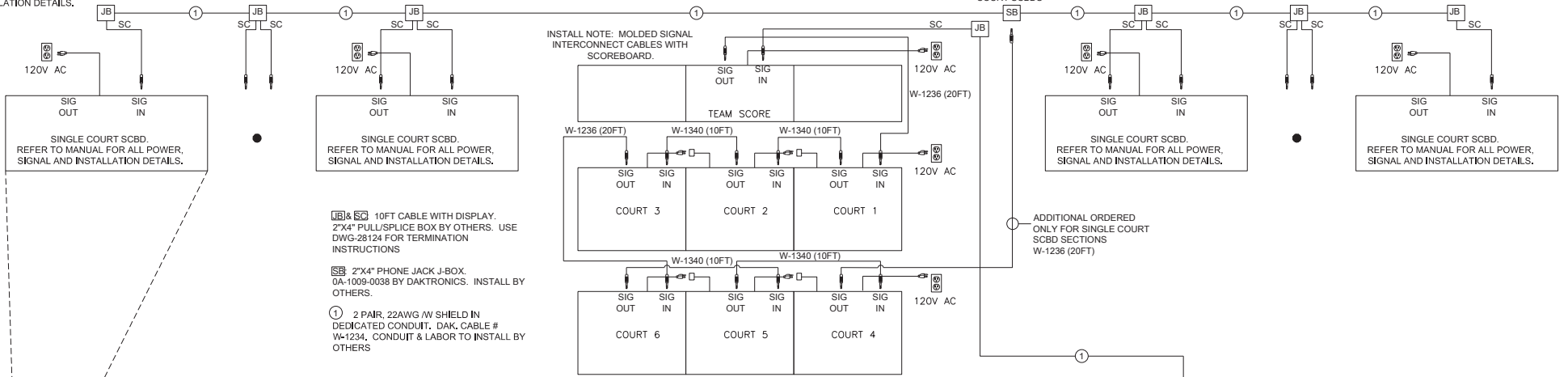

NOTE: THE 6 RC-100 CONTROLLERS USE CHANNELS 1-15. HOWEVER, THE BASE STATION AND HAND HELD CONTROLLERS MUST BE OPERATING ON THE SAME CHANNEL.

PRODUCTION LOCATION ALLSPORT CG SETUP

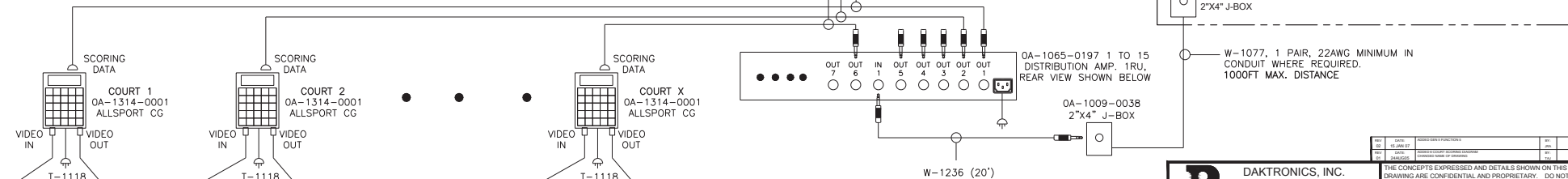

REV	DATE	DESCRIPTION	BY
06	16 OCT 15	UPDATED BASE STATION KIT # TO 0A-1110-0037	PJS
05	02 DEC 13	MOVED POWER AND SIGNAL CABLES TO THE MIDDLE SECTION OF THE TOP TEAM SCORE SCOREBOARD	ACB
04	08 OCT 12	UPDATED BOARD TO B SIZED. ADDED DETAILS TO SHOW INDOOR SCOREBOARD LAYOUT	MWM
03	27 APR 12	UPDATED RC-100 HANDHELD PARTNUMBER AND BOARDER AND TITLE BLOCK	JFL

DAKTRONICS, INC. BROOKINGS, SD 57006		THE CONCEPTS EXPRESSED AND DETAILS SHOWN ON THIS DRAWING ARE CONFIDENTIAL AND PROPRIETARY. DO NOT REPRODUCE BY ANY MEANS WITHOUT THE EXPRESSED WRITTEN CONSENT OF DAKTRONICS, INC. COPYRIGHT 2012 DAKTRONICS, INC.
DO NOT SCALE DRAWING		
PROJ: TENNIS SCOREBOARDS		
TITLE: SYSTEM RISER; TENNIS; INDOOR MULTI-COURT; DAKTENNIS, CG		
DESIGN:	DRAWN: RTAGTOW	DATE: 11 JAN 05
SCALE: NONE	REV: 07	JOB NO: P1164
SHEET	REV	JOB NO.
		FLUNC-TYPE-SIZE
		R-01-B
		231298

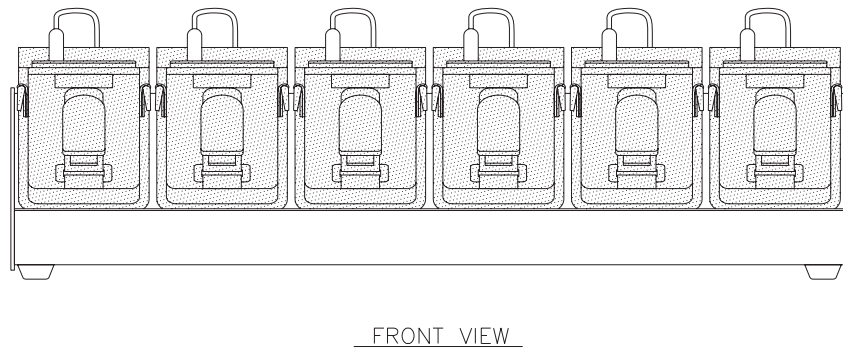
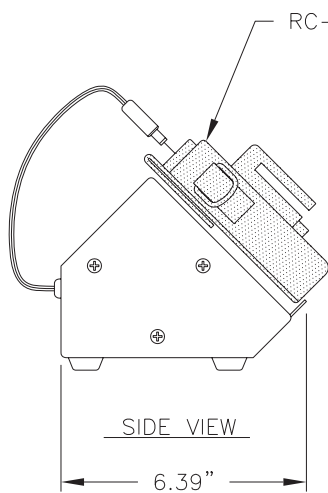
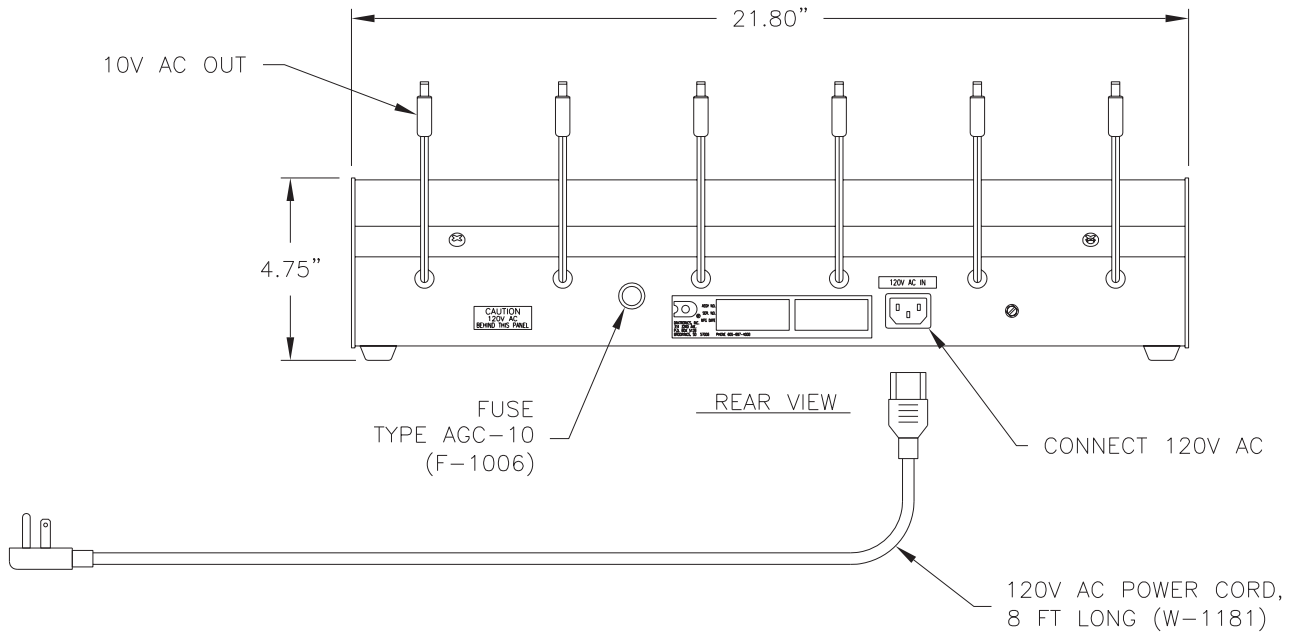

THE RC-100 CHARGING STATION WILL PROVIDE POWER TO CHARGE THE BATTERY IN UP TO SIX RC-100 CONSOLES AT ONE TIME.

PLACE RC-100 CONSOLES FACE DOWN ON THE FRONT OF THE CHARGING STATION.
 PLUG THE CORDS INTO THE POWER JACKS ON THE CONSOLES.
 CONNECT THE 120V AC POWER CORD INTO THE JACK IN THE BACK OF THE CHARGING STATION.

THE CONSOLES CAN REMAIN CONNECTED TO THE CHARGING STATION AFTER CHARGING IS COMPLETE.
 THE BATTERY IN THE RC-100 IS NOT FIELD REPLACEABLE. IF A BATTERY FAILS, CONTACT DAKTRONICS FOR REPLACEMENT SERVICE.

CHARGING STATION WEIGHT: ABOUT 10 LBS, WITHOUT RC-100 CONSOLES.
 MAX. POWER CONSUMPTION: 100 WATTS.

THE CONCEPTS EXPRESSED AND DETAILS SHOWN ON THIS DRAWING ARE CONFIDENTIAL AND PROPRIETARY. DO NOT REPRODUCE BY ANY MEANS, INCLUDING ELECTRONICALLY WITHOUT THE EXPRESSED WRITTEN CONSENT OF DAKTRONICS, INC. COPYRIGHT 2004 DAKTRONICS, INC.			
DAKTRONICS, INC. BROOKINGS, SD 57006			
PROJ: RC-100 CONSOLE			
TITLE: CHARGING STATION, SPECIFICATIONS & OPERATION			
DES. BY: AVB		DRAWN BY: A VANBEMMEL	
		DATE: 14 JAN 04	
REVISION	APPR. BY:	1110-R04A-231674	
00	SCALE: 1=5		

REV.	DATE	DESCRIPTION	BY	APPR.

INDOOR SCOREBOARD LAYOUT
REFER TO MANUAL FOR ALL POWER, SIGNAL AND INSTALLATION DETAILS.

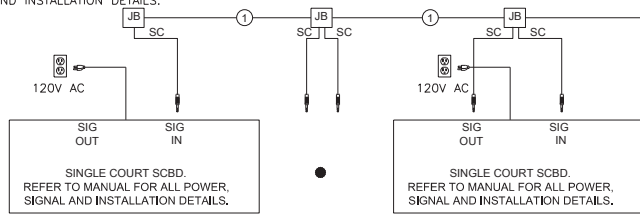

JB & SC 10FT CABLE WITH DISPLAY. 2"x4" PULL/SPLICE BOX BY OTHERS. USE DWG-28124 FOR TERMINATION INSTRUCTIONS

SB 2"x4" PHONE JACK J-BOX. 0A-1009-0038 BY DAKTRONICS. INSTALL BY OTHERS.

① 2 PAIR, 22AWG W/ SHIELD IN DEDICATED CONDUIT. DAK. CABLE # W-1234. CONDUIT & LABOR TO INSTALL BY OTHERS

REAR VIEW

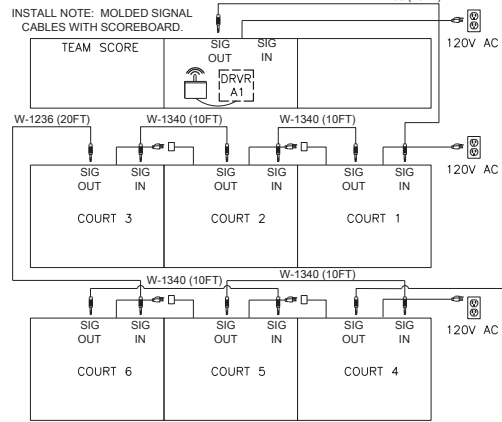

ADD ONLY FOR SINGLE COURT SCBDS

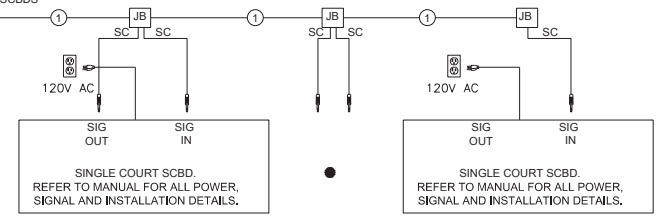

ADD ONLY FOR SINGLE COURT SCBD SECTIONS W-1236 (20FT)

OUTDOOR SCOREBOARD LAYOUT
REFER TO MANUAL FOR ALL POWER, SIGNAL AND INSTALLATION DETAILS.

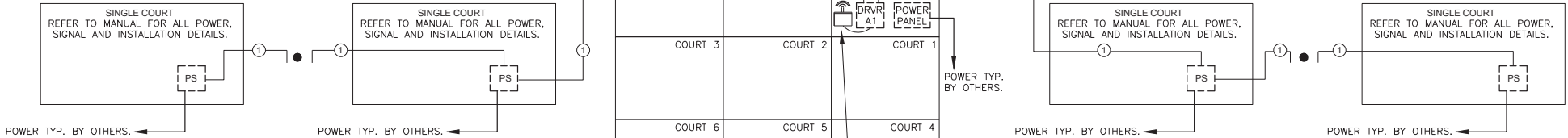

PS INTERNAL PWR/SIG. TERM LOCATION. EXACTLY LOCATION IS DETERMINED BY MODEL PURCHASED.

① 2 PAIR, 22AWG W/ SHIELD IN DEDICATED CONDUIT. DAK. CABLE # W-1234. CONDUIT & LABOR TO INSTALL BY OTHERS

REAR VIEW

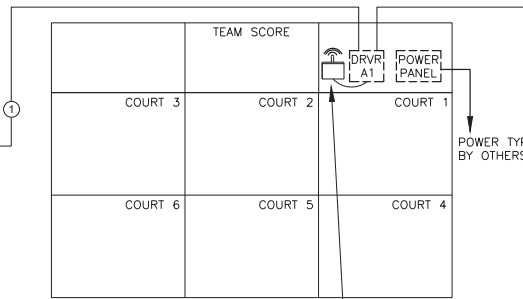

0A-1110-0035
FUNCTION SETTING = 5

NOTE: RC-100 SCOREBOARD RECEIVER BASE STATION IS TYPICALLY LOCATED BEHIND THE FRONT ACCESS LOCATION OF DISPLAY FOR BOTH INDOOR AND OUTDOOR.

RC-100 AT EACH COURT. COMMUNICATION TO MAIN MULTI-COURT RECEIVER.



0A-1110-0053
CODE: 08
INSERT: LL-2607
TYP. ⑥6

NOTE: THE 6 RC-100 CONTROLLERS USE CHANNELS 1-15. HOWEVER, THE BASE STATION AND HAND HELD CONTROLLERS MUST BE OPERATING ON THE SAME CHANNEL.

FUNCTION TABLE

FUNCTION NUMBER	DESCRIPTION
0	DEFAULT FUNCTION (LAST POWER UP FUNCTION) CAN HAND HELD (JUDGES) CONSOLE
2	BASEBALL/TENNIS SCOREBOARD CONTROLLER GEN I (ALLSPORT)
3	DATETIME/DATAMASTER DISPLAY CONTROL
5	BASEBALL/TENNIS SCOREBOARD CONTROLLER GEN II (ALLSPORT)

REV	DATE	DESCRIPTION	BY
05	02 DEC 13	MOVED POWER AND SIGNAL CABLES TO THE MIDDLE SECTION OF THE TOP TEAM SCORE SCOREBOARD	ACB
04	08 OCT 12	UPDATE BOARD TO B - SIZE. SHOW INDOOR AND OUTDOOR DETAIL UPDATES	MWM
03	27 APR 12	UPDATED RC-100 HANDHELD PART NUMBER UPDATED BOARDER AND TITLE BLOCK	JFL
02	15 JAN 07	ADDED FUNCTION 5 GEN II	JRA
01	23AUG05	ADDED 6 COURT SCORING DIAGRAM CHANGED NAME OF DRAWING	TJL

DAKTRONICS, INC.
BROOKINGS, SD 57006
DO NOT SCALE DRAWING

PROJ: TENNIS SCOREBOARDS			
TITLE: SYSTEM RISER; TENNIS; MULTI-COURT, RC-100 DIRECT			
DESIGN:	DRAWN: RTAGTOW	DATE: 02 FEB 05	
SCALE: NONE	REV	JOB NO.	FUNC-TYPE-SIZE
SHEET	05	P1164	R-01-B

233254

TOP VIEW
BASE STATION VIEW WITH FUNCTION SETTINGS CHART

STEP 1
 USING A SMALL FLAT HEAD SCREW DRIVER OR YOUR FINGERS CHANGE THE SWITCHES TO THE DESIRED CHANNEL AND FUNCTION NUMBER. (REFER TO STEP 1 VIEW AND CHART FOR CHANNEL SELECTION.)

STEP 2
 NOTE THE CHANNEL NUMBER SET FOR THIS UNIT.

STEP 3
 BASE STATION IS SET IN FACTORY FOR SERVER MODE. FOR CLIENT MODE, SET JUMPERS TO RIGHT MOST POSITION.

STEP 1 CHART

FUNCTION SETTING	FUNCTION (SERVER MODE)
0	DEFAULT FUNCTION (LAST POWER UP FUNCTION)
1	CAN HANDHELD JUDGES CONSOLE
2	ALL SPORT SCBD CONTROLLER - GEN I
3	DATA TIME MASTER DISPLAY CONTROLLER
5	ALL SPORT SCBD CONTROLLER - GEN II
F	RESET MEMORY/TEST
4, 6-E	RESERVED

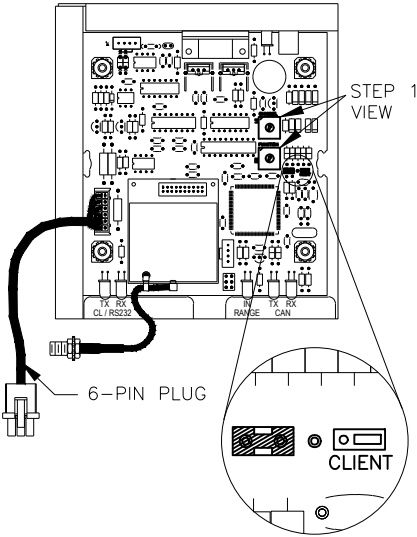

SIDE VIEW
BASE STATION MOUNTING DETAILS FOR MOST OUTDOOR SCOREBOARDS

NOTE: MOUNT THE BASE STATION INTERNALLY, CHECK SO IT WILL NOT INTERFERE WITH ANYTHING.

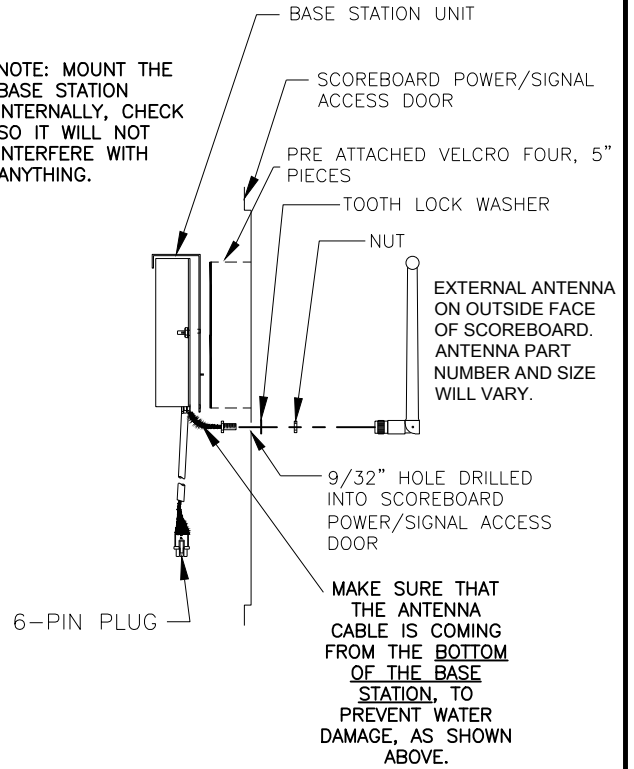

CONNECTING THE BASE STATION WIRE HARNESS
FRONT VIEW OF DRIVER ENCLOSURE; LID REMOVED

GYRUS VIEW

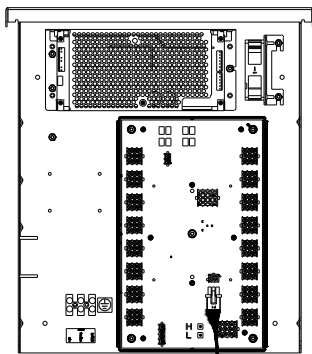

PLUG THE 6-PIN MALE PLUG FROM THE BASE STATION INTO THE MATING 6-PIN JACK (J21) ON THE DRIVER PCB AS SHOWN.

LEGACY VIEW

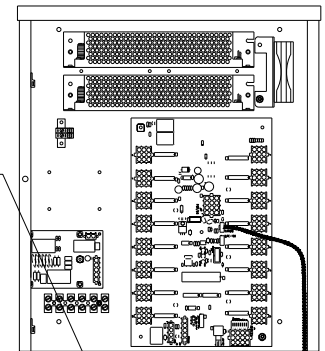

PLUG THE 6-PIN MALE PLUG FROM THE BASE STATION INTO THE MATING 6-PIN JACK OF THE ADAPTOR HARNESS (W-2913).
 PLUG THE MALE 5-PIN END OF THE ADAPTER HARNESS INTO THE MATING 5-PIN CONNECTOR (J45) COMING FROM THE DRIVER.

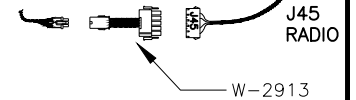

DAKTRONICS, INC. BROOKINGS, SD 57006 DO NOT SCALE DRAWING		THE CONCEPTS EXPRESSED AND DETAILS SHOWN ON THIS DRAWING ARE CONFIDENTIAL AND PROPRIETARY. DO NOT REPRODUCE BY ANY MEANS WITHOUT THE EXPRESSED WRITTEN CONSENT OF DAKTRONICS, INC. COPYRIGHT 2011 DAKTRONICS, INC.	
		PROJ:RC-100 TITLE:BASE STATION: OUTDOOR INSTALLATION	
DESIGN:MMILLER SCALE: 1 = 7		DRAWN:APAGE DATE: 11 MAR 05	
SHEET REV 03		JOB NO: P1110	
FUNC-TYPE-SIZE E-07-A		236394	

03	18 FEB 15	REMOVED "BEFORE JAN 2007" VIEW ADDED NEW GYRUS VIEW UPDATED BASE STATION VIEWS	BJG
02	23 AUG 11	ADDED NEW DETAIL TO DRAWING UPDATED TITLE BLOCK AND FUNCTION CHART	JJL
01	18 JUNE 08	ADDED STEP 1.4 AND DETAIL	AMG

NOTES:

THIS IS NOT A SCALED DRAWING AND SHOULD BE USED FOR POWER AND SIGNAL REQUIREMENTS ONLY.

IT IS THE RESPONSIBILITY OF THE ELECTRICAL INSTALLATION CONTRACTOR TO ENSURE THAT ALL ELECTRICAL WORK PERFORMED ON SITE MEETS OR EXCEEDS ALL LOCAL AND NATIONAL ELECTRICAL CODES.

ALL DISPLAYS MUST BE GROUNDED PER ARTICLE 250 AND 600 OF THE NATIONAL ELECTRICAL CODE WITH NO MORE THAN 10 OHMS GROUND RESISTANCE.

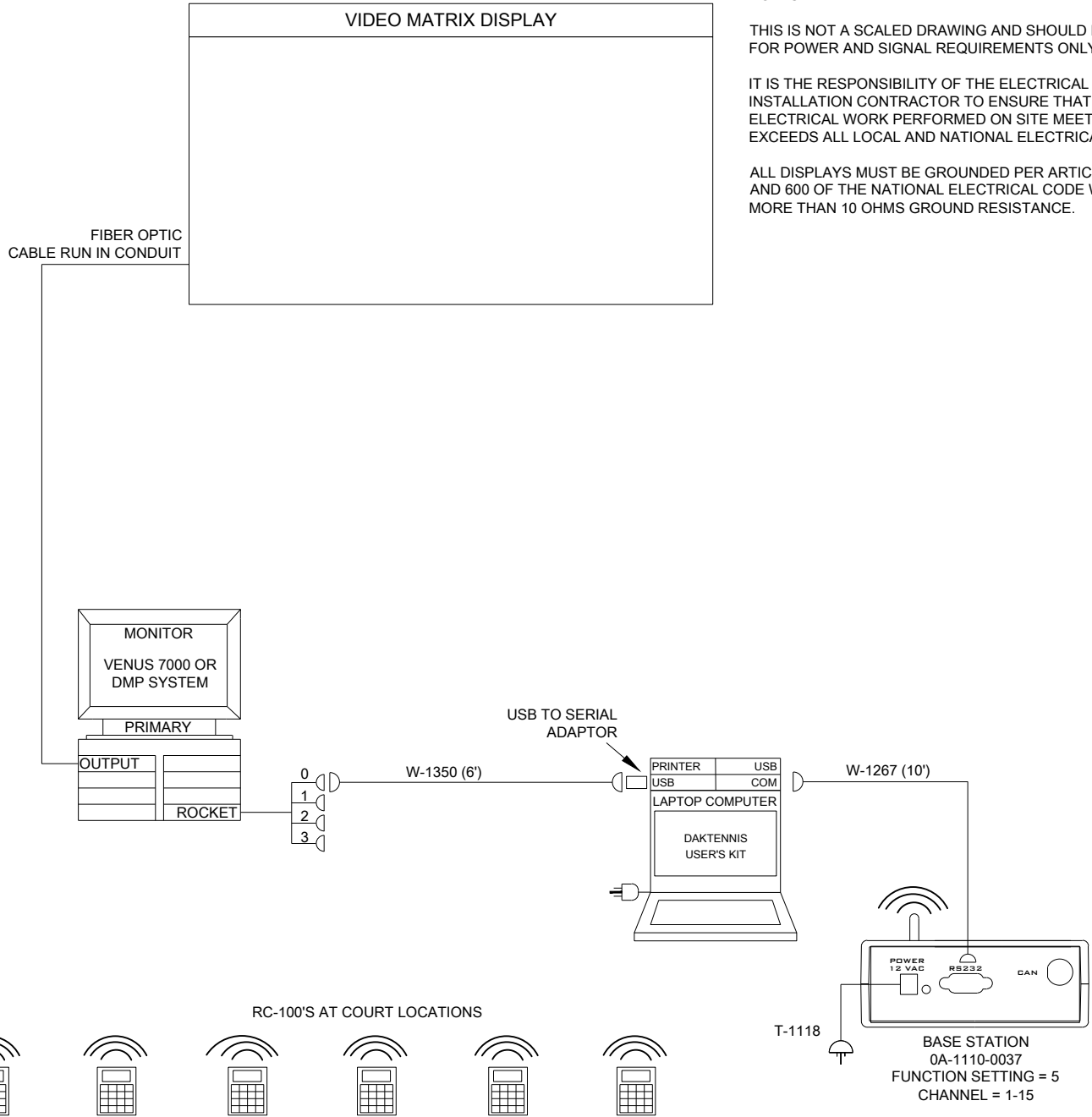

RC-100 WIRELESS HANDHELD: 0A-1110-0053, TYP. @6. INCLUDED IN RC-100 HANDHELD, CONTROLLER KIT: 0A-1110-0102.

NOTE:
THE (6) RC-100 CONTROLLERS USE CHANNELS 1-15, HOWEVER, THE BASE STATION AND HAND HELD CONTROLLERS MUST BE OPERATING ON THE SAME CHANNEL. USE CODE 08 FOR TENNIS.

SEE TABLE BELOW FOR CONTENTS OF RC-100 HANDHELD, CONTROLLER KIT: 0A-1110-0102

PART ID	ASSEMBLY #	DESCRIPTION AND OPERATOR INFO
	0A-1000-1079	CD; SOFTWARE, ALL SPORT MANUALS
	0A-1110-0053	RC-100 WIRELESS HANDHELD G2
	EN-1995	RC-100 BLACK, SOFT CARRY CASE
	T-1118	TRANSFORMER; 12VAC; WALLPACK 6' CORD
RC-100 INSERT KIT	LL-2806	RC-100 TENNIS INSERT USE CODE 08

REV	DATE	DESCRIPTION	BY
05	16 OCT 15	UPDATED BASE STATION KIT # TO 0A-1110-0037	PJS
04	20 MAY 13	UPDATED RC-100 INSERT PART # TO LL-2806. ADDED RC-100 CONTROLLER KIT TABLE.	SMB
03	09 OCT 12	UPDATED BORDER AND GENERAL DETAILS WITH NEW INFORMATION	MWM
02	27 APR 12	UPDATED RC-100 HANDHELD PART NUMBER UPDATED BORDER AND TITLE BLOCK	JFL
01	30 JUL 08	CORRECTED WIRE PART #	KZB

DAKTRONICS, INC. BROOKINGS, SD 57006		THE CONCEPTS EXPRESSED AND DETAILS SHOWN ON THIS DRAWING ARE CONFIDENTIAL AND PROPRIETARY. DO NOT REPRODUCE BY ANY MEANS WITHOUT THE EXPRESSED WRITTEN CONSENT OF DAKTRONICS, INC. COPYRIGHT 2012 DAKTRONICS, INC.
DO NOT SCALE DRAWING		
PROJ: TENNIS SCOREBOARD TITLE: SYSTEM RISER DIAGRAM; DAKTENNIS, VIDEO CONTROL		
DESIGN: RTAGTOW	DRAWN: TJOHNSON	DATE: 24AUG05
SCALE: NONE		
SHEET	REV	JOB NO:
	06	P 1164
FUNC - TYPE - SIZE		251996
E - 10 - A		

NOTE:
 SAMPLE SCOREBOARD MODEL SHOWN. SEE
 SPECIFICATION MATERIAL ON MODEL PURCHASED.

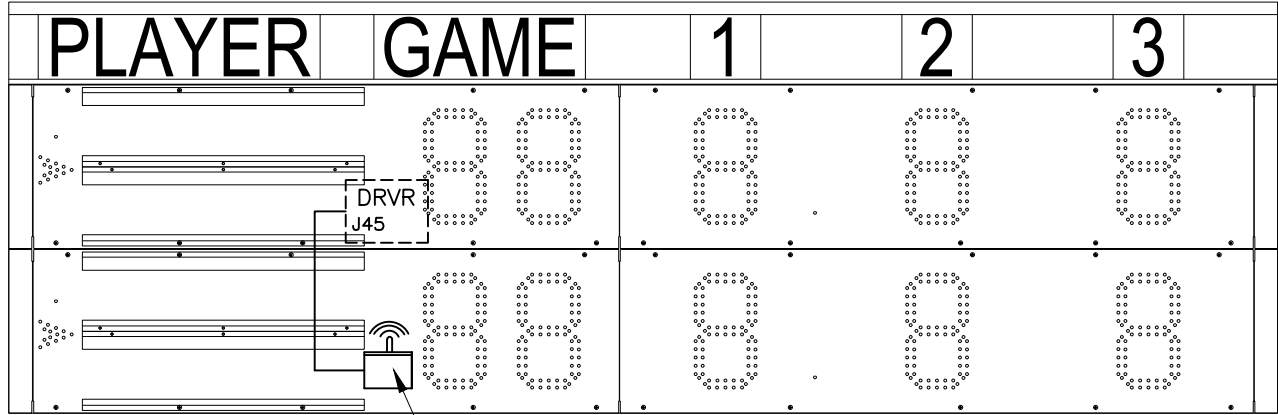

0A-1110-0035
 FUNCTION SETTING = 5

NOTE: RC-100 SCOREBOARD RECEIVER
 BASE STATION IS LOCATED BEHIND THE
 FRONT ACCESS PANEL OF DISPLAY.

NOTE:
 THE WIRELESS BASE STATION COMES PRE-SET TO
 CHANNEL 1. HOWEVER, CHANNELS 1-15 CAN BE
 USED.

FUNCTION TABLE

FUNCTION NUMBER	DESCRIPTION
0	DEFAULT FUNCTION (LAST POWER UP FUNCTION)
1	CAN HAND HELD (JUDGES) CONSOLE
2	BASEBALL/TENNIS SCOREBOARD CONTROLLER GEN I (ALLSPORT)
3	DATETIME/DATAMASTER DISPLAY CONTROL
5	BASEBALL/TENNIS SCOREBOARD CONTROLLER GEN II (ALLSPORT)

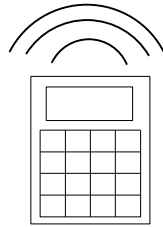

0A-1110-0053
 INSERT: LL-2607 (TENNIS) CODE 08

 DAKTRONICS, INC. BROOKINGS, SD 57006	THE CONCEPTS EXPRESSED AND DETAILS SHOWN ON THIS DRAWING ARE CONFIDENTIAL AND PROPRIETARY. DO NOT REPRODUCE BY ANY MEANS WITHOUT THE EXPRESSED WRITTEN CONSENT OF DAKTRONICS, INC. COPYRIGHT 2012 DAKTRONICS, INC.	
	DO NOT SCALE DRAWING	
PROJ: TENNIS SCOREBOARDS TITLE: SYSTEM RISER; TENNIS; INDOOR/OUTDOOR SINGLE COURT, RC-100		
DESIGN: SCALE: NONE	DRAWN: TJOHNSON JOB NO: P1164	DATE: 29AUG05 FUNC-TYPE-SIZE: R-01-A
SHEET: 02 REV: 02	JOB NO: P1164	252412

REV 02	DATE: 27 APR 12	UPDATED RC-100 HANDHELD PART NUMBER UPDATED BOARDER AND TITLE BLOCK	BY: JFL
01	22 OCT 09	UPDATED FUNCTION SETTING AND TABLE. ALSO ADDED NOTE ABOUT SCOREBOARD.	EJS

TOP VIEW

STEP 1 CHART

STEP 1

USING A SMALL FLAT HEAD SCREW DRIVER OR YOUR FINGERS CHANGE THE SWITCHES TO THE DESIRED CHANNEL AND FUNCTION NUMBER. (REFER TO STEP 1 VIEW AND CHART FOR CHANNEL SELECTION.)

STEP 2

NOTE THE CHANNEL NUMBER SET FOR THIS UNIT.

STEP 3

BASE STATION IS SET IN FACTORY FOR SERVER MODE. FOR CLIENT MODE, SET JUMPERS TO RIGHT MOST POSITION.

FUNCTION SETTING	FUNCTION (SERVER MODE)
0	DEFAULT FUNCTION (LAST POWER UP FUNCTION)
1	CAN HANDHELD JUDGES CONSOLE
2	ALL SPORT SCBD CONTROLLER - GEN I
3	DATA TIME MASTER DISPLAY CONTROLLER
5	ALL SPORT SCBD CONTROLLER - GEN II
F	RESET MEMORY/TEST
4, 6-E	RESERVED

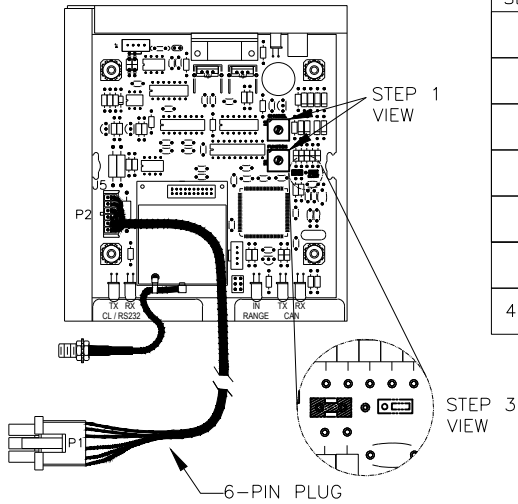

BASE STATION MOUNTING DETAILS FOR MOST OUTDOOR SCOREBOARDS.

NOTE: MOUNT THE BASE STATION INTERNALLY, CHECK SO IT WILL NOT INTERFERE WITH ANYTHING.

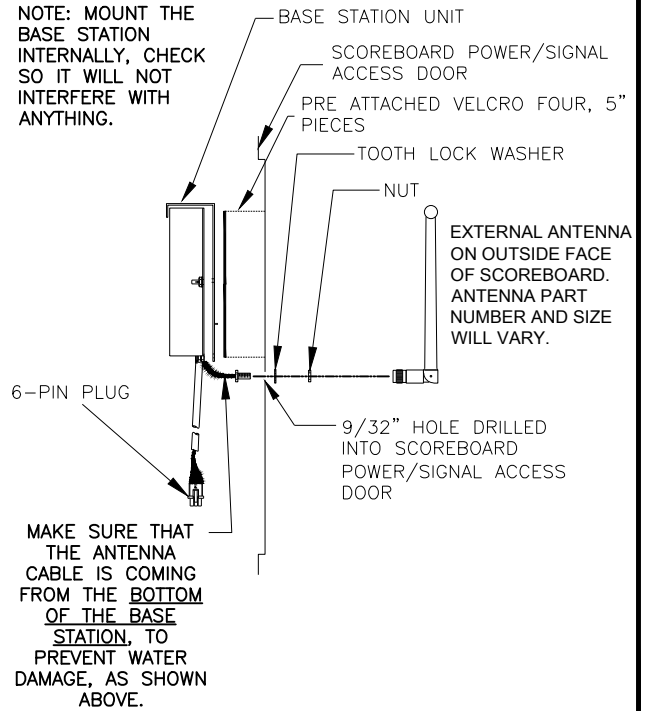

PLUG THE 6-PIN MALE PLUG FROM THE BASE STATION INTO THE MATING 6-PIN JACK OF THE ADAPTOR HARNESS (W-2913).
 PLUG THE MALE 5-PIN END OF THE ADAPTER HARNESS INTO THE MATING 5-PIN CONNECTOR (J45) COMING FROM THE DRIVER.

DAKTRONICS, INC. BROOKINGS, SD 57006 DO NOT SCALE DRAWING		THE CONCEPTS EXPRESSED AND DETAILS SHOWN ON THIS DRAWING ARE CONFIDENTIAL AND PROPRIETARY. DO NOT REPRODUCE BY ANY MEANS WITHOUT THE EXPRESS WRITTEN CONSENT OF DAKTRONICS, INC. COPYRIGHT 2015 DAKTRONICS, INC.	
PROJ: RC-100 TITLE: BASE STATION: DISTVIEW SCOREBOARD INSTALLATION			
DESIGN:		DRAWN: APAGE	
SCALE: 1 = 7		DATE: 14 MAR 06	
SHEET	REV	JOB NO:	FUNC-TYPE-SIZE
	04	P 1110	E - 07 - A
			266717

REV	DATE:	UPDATED VIEWS TO INCLUDE RADIO ADAPTER HARNESS	BY:
04	13 MAR 15		KCS
03	12 APR 10	ADDED FUNCTION 5	KZB
01	18 JUN 08	ADDED STEP 1.4 AND DETAIL.	AMG

OUTDOOR SCOREBOARD LAYOUT
REFER TO MANUAL FOR ALL POWER,
SIGNAL AND INSTALLATION DETAILS.

REAR VIEW

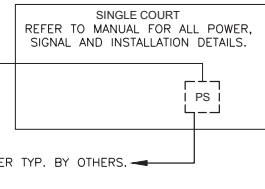
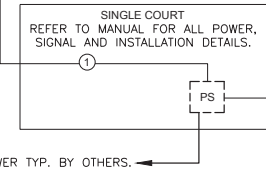
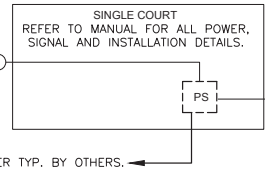
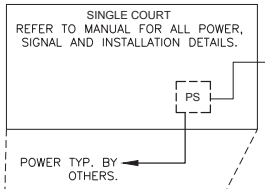
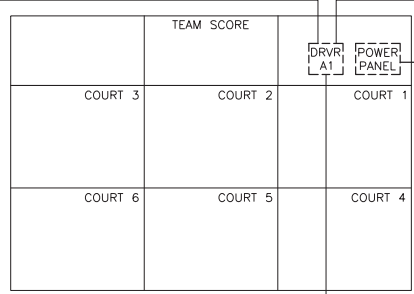

PS INTERNAL PWR/SIG. TERM LOCATION. EXACTLY LOCATION IS DETERMINED BY MODEL PURCHASED.

① 2 PAIR, 22AWG /W SHIELD IN DEDICATED CONDUIT. DAK. CABLE # W-1234. CONDUIT & LABOR TO INSTALL BY OTHERS

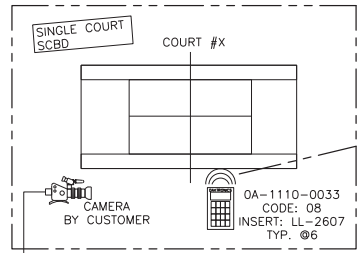
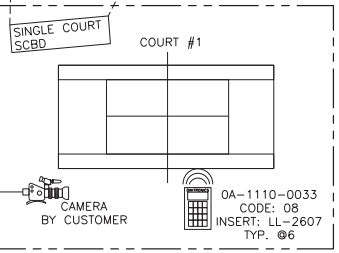

NOTE: THE 6 RC-100 CONTROLLERS USE CHANNELS 1-15. HOWEVER, THE BASE STATION AND HAND HELD CONTROLLERS MUST BE OPERATING ON THE SAME CHANNEL.

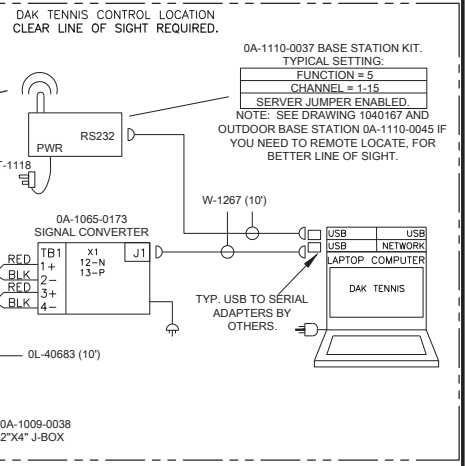

PRODUCTION LOCATION ALLSPORT CG SETUP

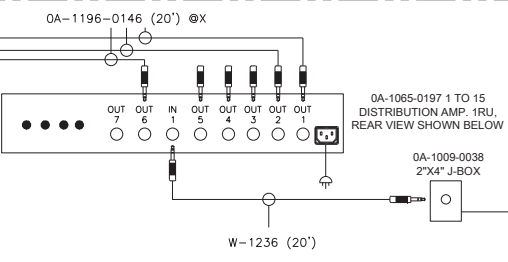
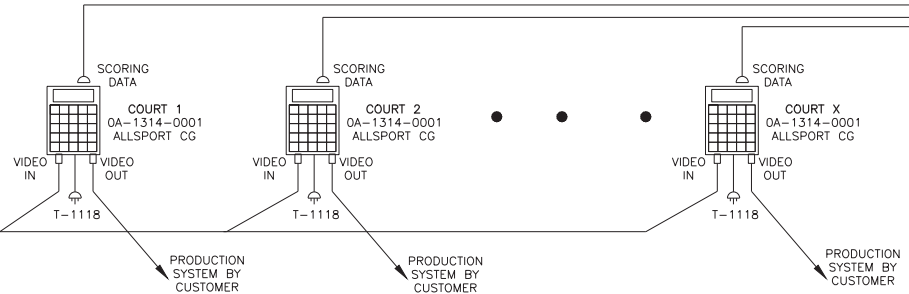

		THE CONCEPTS EXPRESSED AND DETAILS SHOWN ON THIS DRAWING ARE CONFIDENTIAL AND PROPRIETARY. DO NOT REPRODUCE BY ANY MEANS WITHOUT THE EXPRESSED WRITTEN CONSENT OF DAKTRONICS, INC. COPYRIGHT 2011 DAKTRONICS, INC.	
BROOKINGS, SD 57006 DO NOT SCALE DRAWING			
PROJ: TENNIS SCOREBOARDS TITLE: SYSTEM RISER; TENNIS; OUTDOOR MULTI-COURT DAKTENNIS_CG			
DESIGN: MMILLER	DRAWN: MMILLER	DATE: 02 OCT 06	
SCALE: NONE			
SHEET	REV	JOB NO.	FLUNC-TYPE-SIZE
	04	P1164	R-01-B
			281236

REV 03	DATE 16 OCT 15	UPDATED BASE STATION KIT # TO 0A-1110-0037	BY: PJS
REV 02	DATE 09 OCT 12	UPDATED DRAWING DETAILS TO SHOW THE SCOREBOARD LAYOUTS BETTER	BY: MMM
REV 01	DATE 04 JAN 12	ADDED SINGLE COURT SCOREBOARDS	BY: JUL

PRIMARY WIRELESS
SETUP

FRONT VIEW

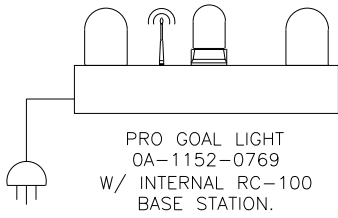

RC-100 WIRELESS HANDHELD

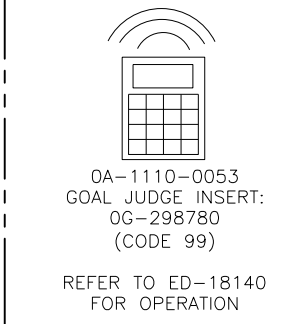

SECONDARY WIRED
SETUP

SIDE VIEW

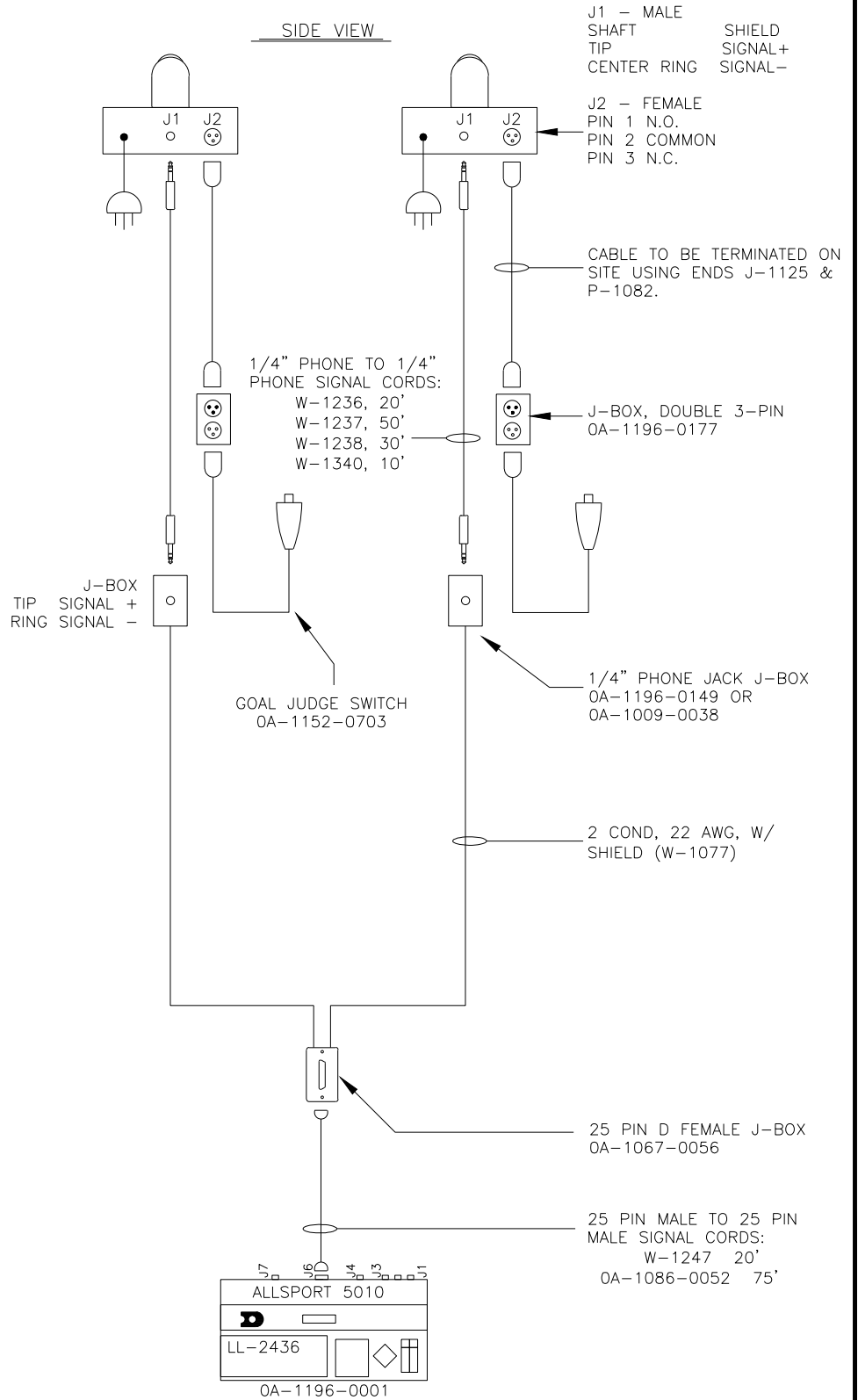

	DAKTRONICS, INC. BROOKINGS, SD 57006	THE CONCEPTS EXPRESSED AND DETAILS SHOWN ON THIS DRAWING ARE CONFIDENTIAL AND PROPRIETARY. DO NOT REPRODUCE BY ANY MEANS WITHOUT THE EXPRESSED WRITTEN CONSENT OF DAKTRONICS, INC. COPYRIGHT 2012 DAKTRONICS, INC.
	DO NOT SCALE DRAWING	

REV 03	DATE: 21 NOV 12	UPDATED GOAL LIGHTS	BY: KZB
REV 02	DATE: 27 APR 12	UPDATED RC-100 HANDHELD PART NUMBER UPDATED BOARDER AND TITLE BLOCK	BY: JFL
01	DATE: 28 AUG 07	CHANGED RC-100 INSERT.	AMG

PROJ: STANDARD INDOOR LED SCOREBOARDS			
TITLE: RISER DIAGRAM: GOAL INDICATOR SYSTEM W/ RC 100			
DESIGN: MILLER		DRAWN: AGEWERT	
SCALE:			
SHEET	REV	JOB NO:	FUNC-TYPE-SIZE
	03	P1152	R-01-A
			317405

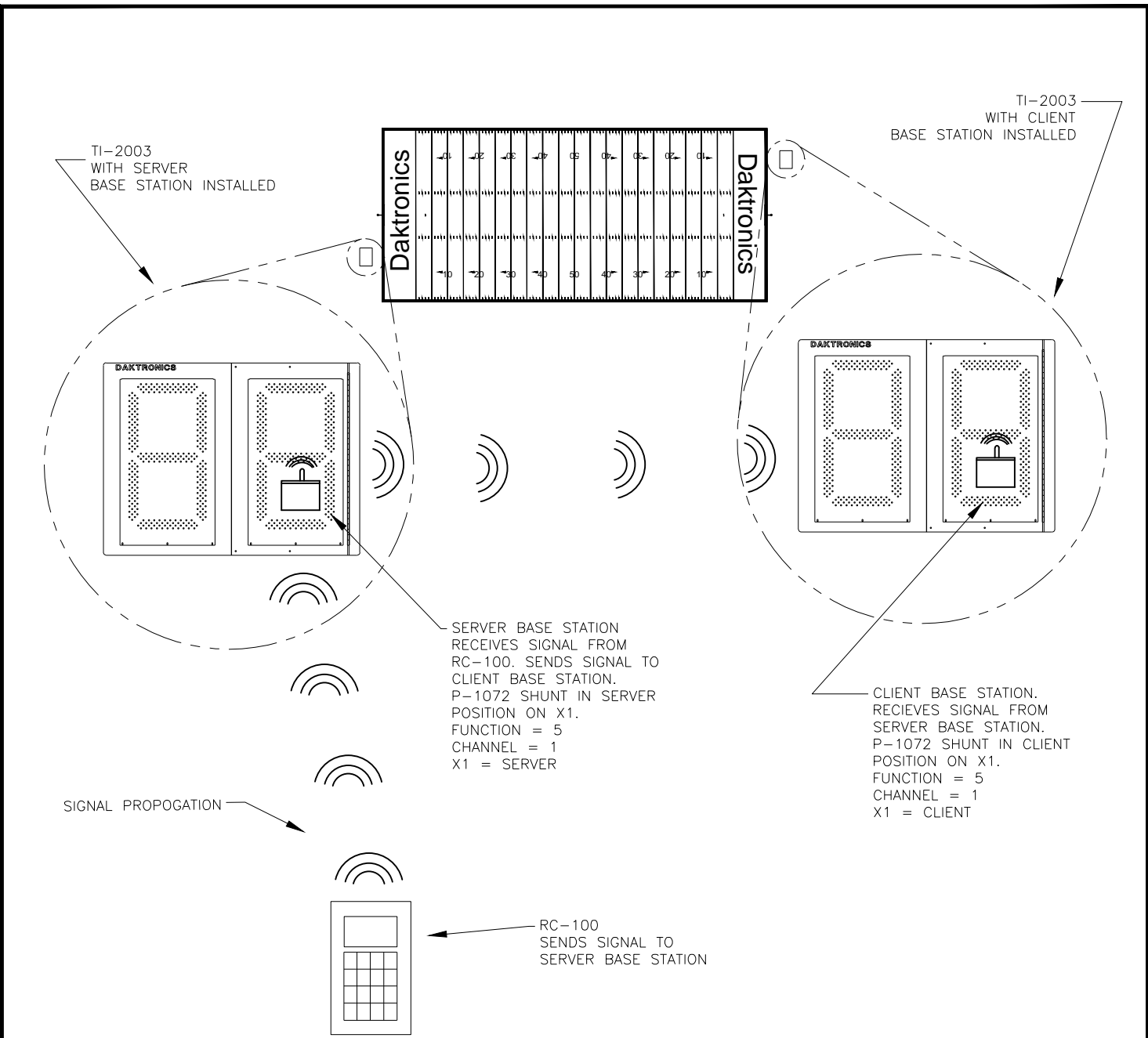

0A-1110-0053
 INSERT: LL-2653 (PLAY CLOCK) CODE 05

NOTE:
 SIGNAL PROPAGATES FROM THE RC-100 TO THE SERVER BASE STATION, THE SERVER BASE STATION THEN SENDS A NEW SIGNAL TO THE CLIENT BASE STATION. RC-100 CAN ONLY COMMUNICATE WITH ONE SERVER BASE STATION AT A TIME.

 DAKTRONICS, INC. BROOKINGS, SD 57006		THE CONCEPTS EXPRESSED AND DETAILS SHOWN ON THIS DRAWING ARE CONFIDENTIAL AND PROPRIETARY. DO NOT REPRODUCE BY ANY MEANS WITHOUT THE EXPRESSED WRITTEN CONSENT OF DAKTRONICS, INC. COPYRIGHT 2012 DAKTRONICS, INC.	
DO NOT SCALE DRAWING			
PROJ: RC-100 SERVER/CLIENT LINE			
TITLE: SYSTEM RISER DIAGRAM: RC-100 SERVER/CLIENT LINE			
DESIGN:	DRAWN: ARICHTE		DATE: 28 AUG 07
SCALE: NONE			
SHEET	REV	JOB NO:	FUNC-TYPE-SIZE
	02	P 1110	R - 01 - A
			317837

REV 02	DATE: 9 FEB 16	ADDED SETTINGS NOTE FOR SERVER AND CLIENT BASE STATIONS	BY: MTR
REV 01	DATE: 27 APR 12	UPDATED RC-100 HANDHELD PART NUMBER UPDATED BOARDER AND TITLE BLOCK	BY: JFL

OUTDOOR BASE STATION
REQUIRES CLEAR LINE OF SITE
WITH HAND HELD RC-100 UNIT.

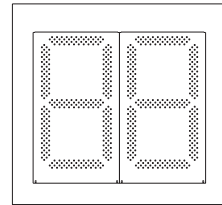
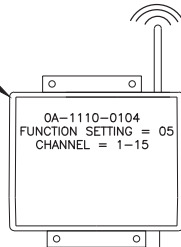

FUNCTION TABLE	
FUNCTION NUMBER	DESCRIPTION
0	DEFAULT FUNCTION (LAST POWER UP FUNCTION)
1	CAN HAND HELD (JUDGES) CONSOLE
2	BASEBALL/TENNIS SCOREBOARD CONTROLLER GEN I (ALLSPORT)
3	DATETIME/DATAMASTER DISPLAY CONTROL
5	BASEBALL/TENNIS SCOREBOARD CONTROLLER GEN II (ALLSPORT)

NOTE:
THE WIRELESS BASE STATION COMES PRE-SET TO CHANNEL 1. HOWEVER, CHANNELS 1-15 CAN BE USED.

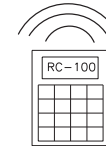

OA-1110-0053
INSERT: OG-319079
(REMOTE START/STOP) CODE 98

25' CABLE ATTACHED TO BASE STATION

RC-100 HANDHELD CONTROLLER CAN BE USED TO CONTROL EITHER THE DOG CLOCK OR GAME CLOCK. THE CONTROL ROOM HANDHELDS CAN BE USED AS BACKUP/ALTERNATIVE CONNECTION.

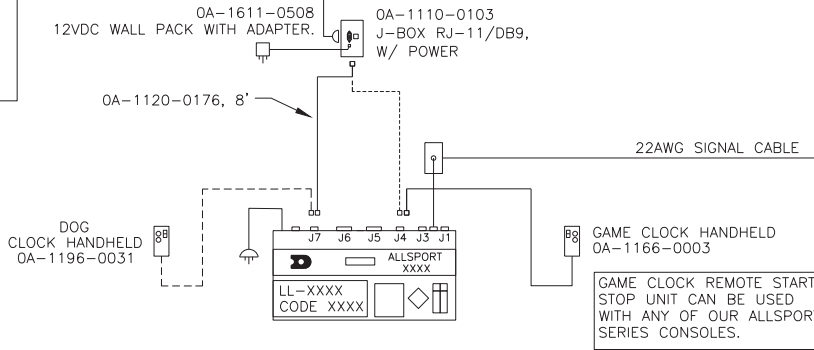

OA-1110-0106, RC-100 REMOTE START/STOP KIT INCLUDES THE FOLLOWING:
OA-1110-0102, RC-100 HAND HELD KIT
OA-1110-0103, RC-100 REMOTE S/S J-BOX
OA-1110-0104, RC-100 REMOTE S/S BASE STATION
OA-1120-0176, 8' RJ-11 CABLE
T-1118, WALL PACK POWER TRANSFORMER
OG-319079, REMOTE START STOP INSERT.

REV	DATE	CHANGED WALL PACK TO OA-1611-0508 PER EC-21669	BY:
04	14 JUN 16		AFH
03	14 NOV 12	FIXED FOR CLARITY	KZB
02	27 APR 12	UPDATED RC-100 HANDHELD PART NUMBER UPDATED BOARDER AND TITLE BLOCK	JFL
01	26 AUG 09	ADDED A GAME CLOCK AND ADDED NOTES FOR ALLSPORT CONTROL	RRS

		<small>THE CONCEPTS EXPRESSED AND DETAILS SHOWN ON THIS DRAWING ARE CONFIDENTIAL AND PROPRIETARY. DO NOT REPRODUCE BY ANY MEANS WITHOUT THE EXPRESS WRITTEN CONSENT OF DAKTRONICS, INC. OR ITS WHOLLY OWNED SUBSIDIARIES. COPYRIGHT 2016 DAKTRONICS, INC. (USA)</small>			
		PROJECT: WIRELESS LINK	TITLE: SYSTEM RISER, RC-100 GAME/DOG CLOCK REMOTE ST/ST		DATE: 5 SEP 07
SCALE: NONE	DO NOT SCALE DRAWING	DESIGN:	JOB NO.: P1110	FUNC - TYPE - SIZE: E-10-B	319037
DRAWN: DDINING					

CONTROL LOCATION

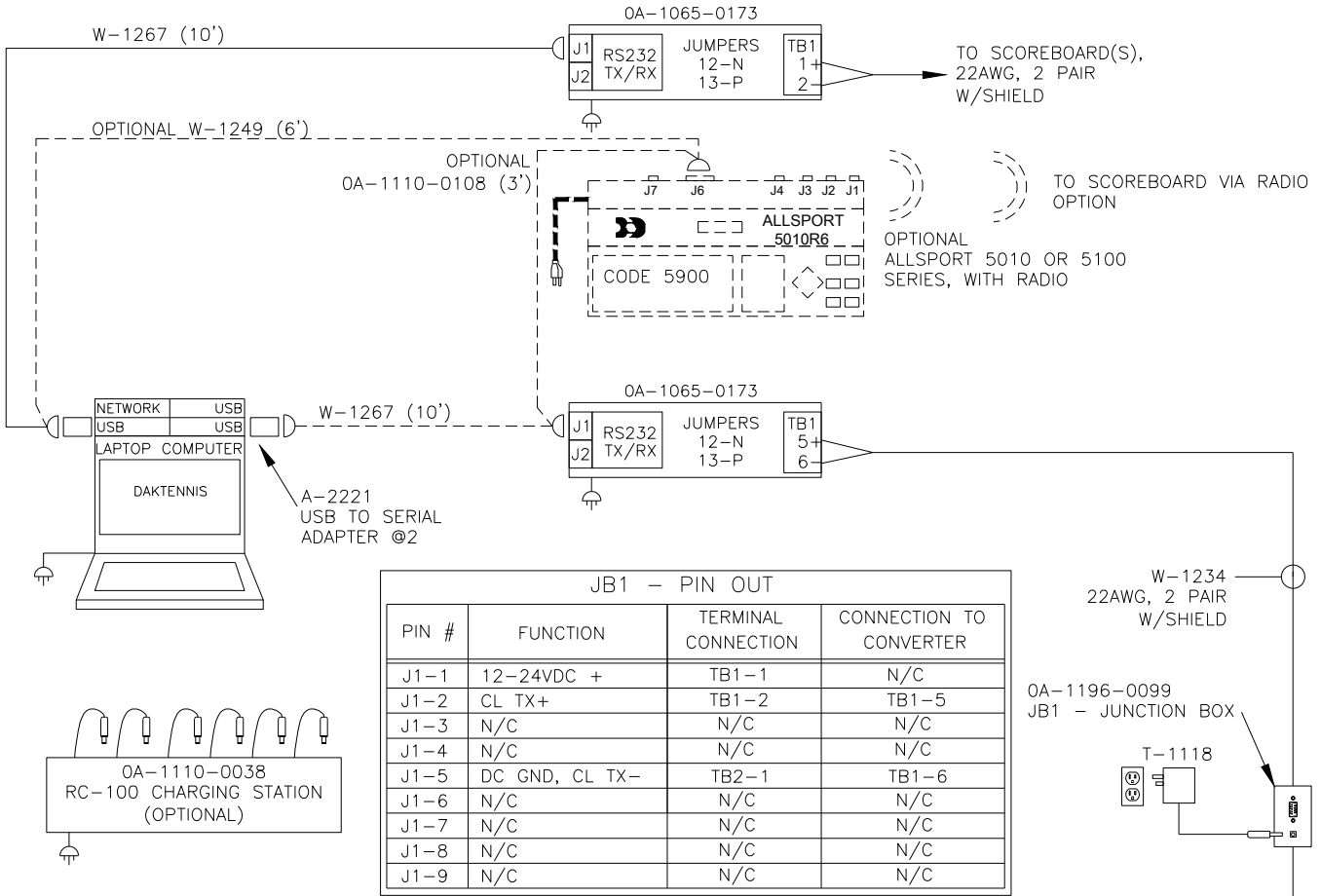

REMOTE LOCATION UP TO 125FT AWAY.

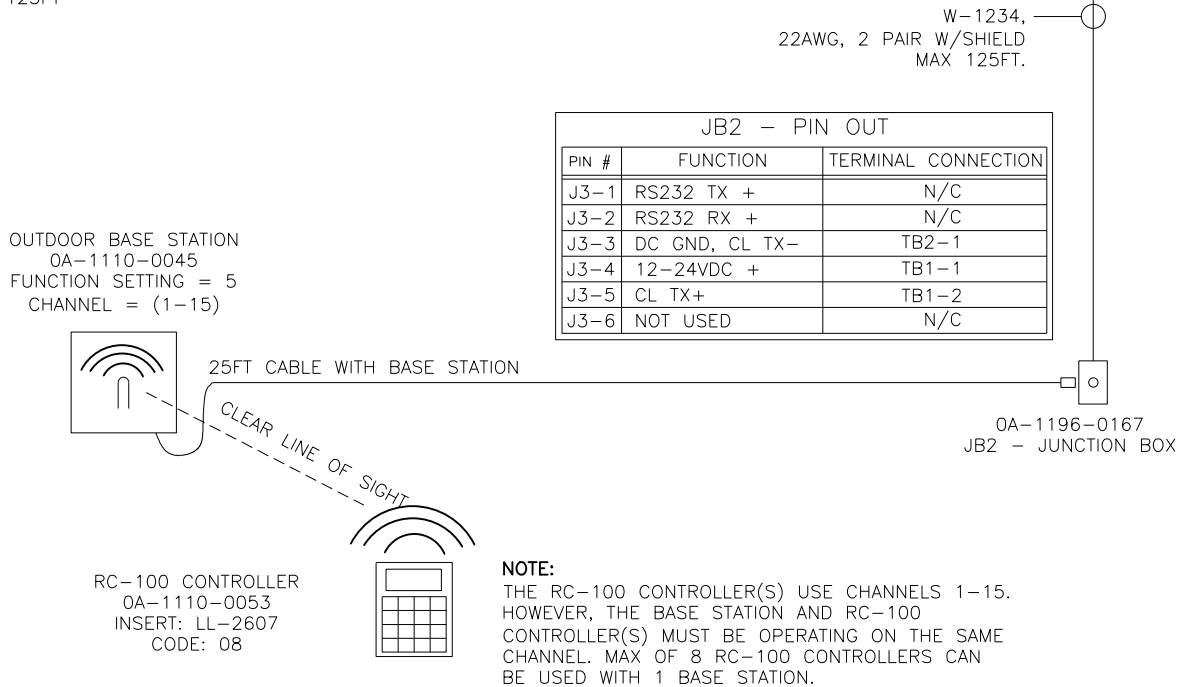

REV 04	DATE: 7 JAN 16	UPDATED JB1 & JB2 PIN OUT TABLES	BY: MTR
REV 03	DATE: 09 MAR 15	ADDED OPTIONAL CABLE OA-1110-0108 TO CONTROL LOCATION	BY: DCS
REV 02	DATE: 30 JAN 13	ADDED SOME TEXT UPDATES TO THE DATA CABLE RUN FROM JB1 TO JB2. ADDED USB TO SERIAL PART #, AND OPTIONAL ALLSPORT RADIO METHOD.	BY: MWM
REV 01	DATE: 27 APR 12	ADDED PART NUMBER FOR RC-100 HANDHELD	BY: JFL

DAKTRONICS, INC.
BROOKINGS, SD 57006

DO NOT SCALE DRAWING

THE CONCEPTS EXPRESSED AND DETAILS SHOWN ON THIS DRAWING ARE CONFIDENTIAL AND PROPRIETARY. DO NOT REPRODUCE BY ANY MEANS WITHOUT THE EXPRESSED WRITTEN CONSENT OF DAKTRONICS, INC. COPYRIGHT 2010 DAKTRONICS, INC.

PROJ: RC-100 TENNIS
TITLE: SYSTEM RISER; TENNIS; DAKTENNIS & REMOTE BASE STATION
DESIGN: KBIERBA DRAWN: KBIERBA DATE: 15 DEC 10
SCALE: NONE

SHEET	REV	JOB NO:	FUNC-TYPE-SIZE
	04	P1110	R-01-A

1040167

INDOOR MULTI-COURT SCOREBOARD LAYOUT
REFER TO MANUAL FOR ALL POWER, SIGNAL, AND
INSTALLATION DETAILS.

REAR VIEW

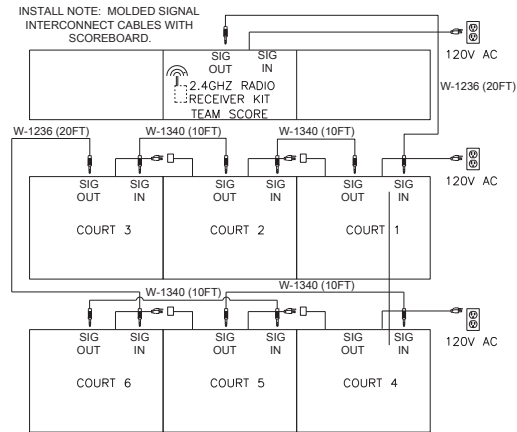

OUTDOOR MULTI-COURT SCOREBOARD LAYOUT
REFER TO MANUAL FOR ALL POWER, SIGNAL, AND
INSTALLATION DETAILS.

REAR VIEW

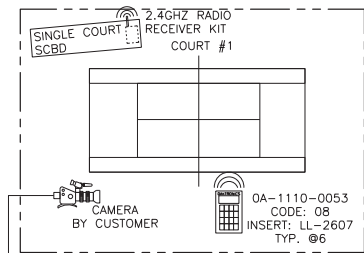
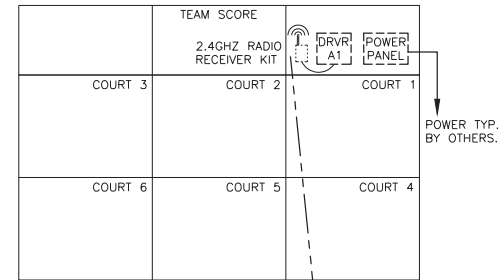

NOTE:
THE 6 RC-100 CONTROLLERS USE CHANNELS
1-15. HOWEVER, THE BASE STATION AND HAND
HELD CONTROLLERS MUST BE OPERATING ON THE
SAME CHANNEL.

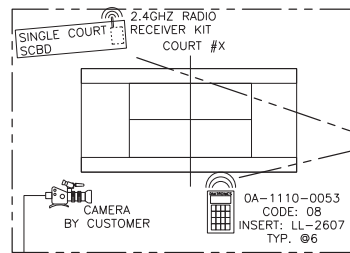

ALL RADIO
COMMUNICATION
REQUIRES CLEAR
LINE OF SIGHT

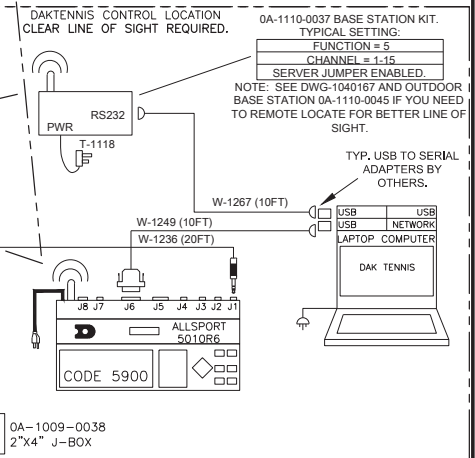

PRODUCTION LOCATION
ALLSPORT CG SETUP

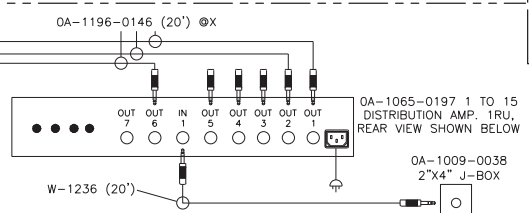
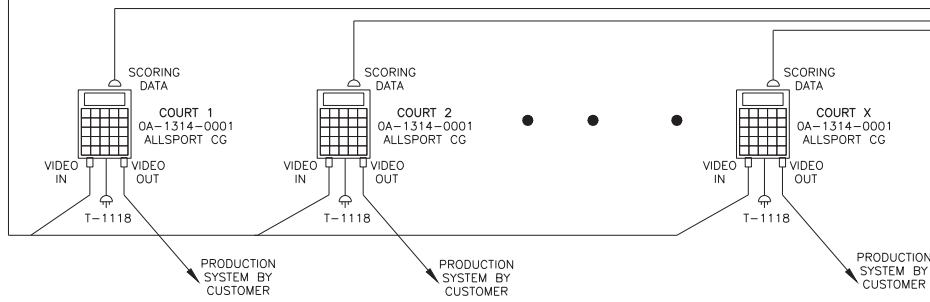

W-1077, 1 PAIR, 22AWG MINIMUM IN
CONDUIT WHERE REQUIRED.
1000FT MAX. DISTANCE

REV 05	DATE: 17 DEC 15	CHANGED WIRE 0A-1374-0106 TO W-1249 AT THE DAKTENNIS DETAIL	BY: MTR
REV 04	DATE: 4 DEC 15	UPDATED BASE STATION KIT FROM 0A-1110-0030 TO 0A-1110-0037	BY: MTR
REV 03	DATE: 02 DEC 13	MOVED POWER AND SIGNAL CABLES TO THE MIDDLE SECTION OF THE TOP TEAM SCORE SCOREBOARD	BY: ACB
REV 02	DATE: 09 OCT 12	UPDATED DRAWING DETAILS TO SHOW THE SCOREBOARD LAYOUTS BETTER	BY: MWM
REV 01	DATE: 19 JUL 12	UPDATED CABLE PART NUMBER FOR ALLSPORT	BY: K2B

		THE CONCEPTS EXPRESSED AND DETAILS SHOWN ON THIS DRAWING ARE CONFIDENTIAL AND PROPRIETARY. DO NOT REPRODUCE BY ANY MEANS WITHOUT THE EXPRESSED WRITTEN CONSENT OF DAKTRONICS, INC. COPYRIGHT 2011 DAKTRONICS, INC.	
PROJECT: TENNIS SCOREBOARD			
TITLE: SYSTEM RISER; TENNIS; MULTI-COURT, DAKTENNIS, RADIO, CG			
DESIGN: RTAGTOW		DRAWN: TJOHNSON	
DATE: 24AUG05			
SCALE: NONE			
SHEET	REV 05	JOB NO. P1164	FLUNC-TYPE-SIZE E-10-B
			1077063

Appendix B: Sport Inserts

<i>Drawing Title</i>	<i>Drawing Number</i>
Insert; LL-2608, RC-100, Rodeo.....	A-231529
Insert: LL-2605- RC-100- Baseball.....	A-231530
Insert; LL-2607, RC-100, Tennis	A-231531
Insert; LL-2606, RC-100, Judges Console	A-231532
Custom Insert; Volleyball, RC-100.....	A-239304
Insert; LL-2613, RC-100 Clock/Score.....	A-239307
Insert; LL-2613 Back, RC-100 Segment Timer	A-247621
Insert, LL-2632, RC-100, Basketball.....	A-253583
Insert; LL-2653, RC-100 Play Clock	A-280870
Insert; LL-2663, RC-100 Goal Judge.....	A-298780
Insert: Custom- RC-100- Start/Stop Remote.....	A-319079
Insert; Custom, RC-100, Football	A-1031603

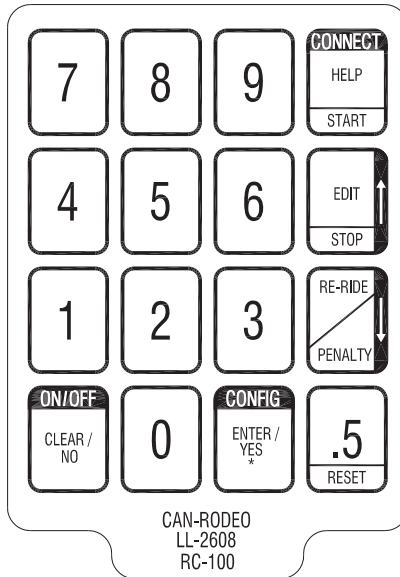

THE CONCEPTS EXPRESSED AND DETAILS SHOWN ON THIS DRAWING ARE CONFIDENTIAL AND PROPRIETARY. DO NOT REPRODUCE BY ANY MEANS, INCLUDING ELECTRONICALLY WITHOUT THE EXPRESSED WRITTEN CONSENT OF DAKTRONICS, INC. COPYRIGHT 2003 DAKTRONICS, INC.

DAKTRONICS, INC. BROOKINGS, SD 57006

PROJ: HANDHELD WIRELESS CAN SYSTEM

TITLE: INSERT; LL-2608, RC-100, RODEO

DES. BY: GWITCHE

DRAWN BY: GWITCHE

DATE: 12 JAN 05

REVISION

APPR. BY:

SCALE: 1 = 1

1110-E07A-231529

REV.	DATE	DESCRIPTION	BY	APPR.

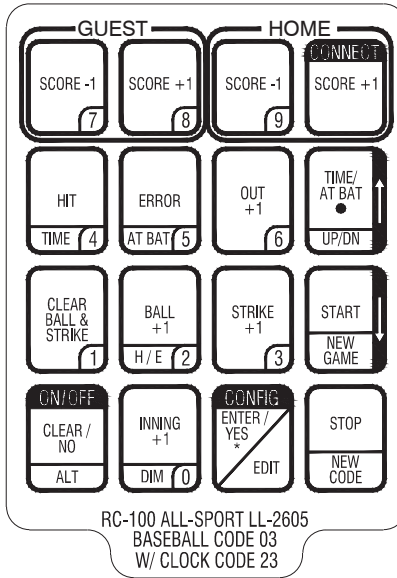

	DAKTRONICS, INC. BROOKINGS, SD 57006	THE CONCEPTS EXPRESSED AND DETAILS SHOWN ON THIS DRAWING ARE CONFIDENTIAL AND PROPRIETARY. DO NOT REPRODUCE BY ANY MEANS WITHOUT THE EXPRESSED WRITTEN CONSENT OF DAKTRONICS, INC. COPYRIGHT 2010 DAKTRONICS, INC.
DO NOT SCALE DRAWING		

REV 03	DATE: 18 JUN 10	ADD H/E LABEL TO KEY 2.	BY: CRD
REV 02	DATE: 27 JUN 08	ADDED BASEBALL WITH CLOCK CODE 13 TEXT	BY: JMC
REV 01	DATE: 21 MAY 07	ADDED TIME/AT BAT CONTROLS	BY: JMC

PROJ: HANDHELD WIRELESS CAN SYSTEM			
TITLE: INSERT: LL-2605- RC-100- BASEBALL			
DESIGN: GWITCHE	DRAWN: GWITCHE	DATE: 12 JAN 05	
SCALE: 1 = 1			
SHEET	REV 03	JOB NO: P1110	FUNC-TYPE-SIZE E-07-A
			231530

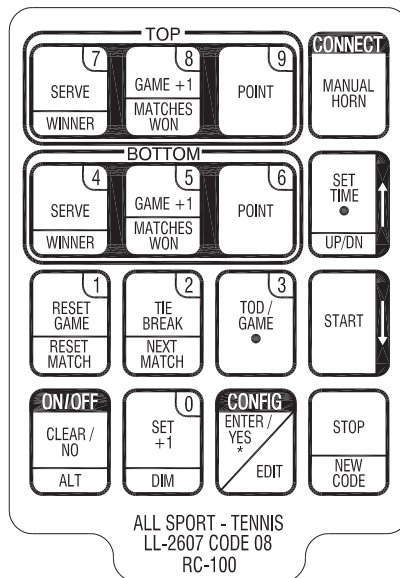

THE CONCEPTS EXPRESSED AND DETAILS SHOWN ON THIS DRAWING ARE CONFIDENTIAL AND PROPRIETARY. DO NOT REPRODUCE BY ANY MEANS, INCLUDING ELECTRONICALLY WITHOUT THE EXPRESSED WRITTEN CONSENT OF DAKTRONICS, INC. COPYRIGHT 2003 DAKTRONICS, INC.

DAKTRONICS, INC. BROOKINGS, SD 57006

PROJ: HANDHELD WIRELESS CAN SYSTEM

TITLE: INSERT; LL-2607, RC-100, TENNIS

DES. BY: GWITCHE

DRAWN BY: GWITCHE

DATE: 12 JAN 05

REV.	DATE	DESCRIPTION	BY	APPR.
01	14 SEP 05	ADDED WINNER TEXT TO SERVE KEYS ADDED NEXT MATCH TEXT TO TIE BREAK KEY	DJU	

REVISION

01

APPR. BY:

SCALE: 1 = 1

1110-E07A-231531

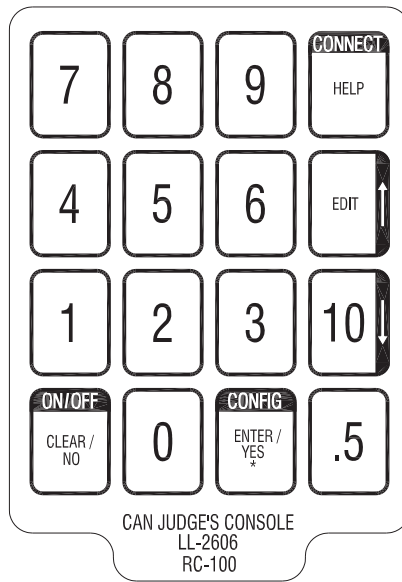

THE CONCEPTS EXPRESSED AND DETAILS SHOWN ON THIS DRAWING ARE CONFIDENTIAL AND PROPRIETARY. DO NOT REPRODUCE BY ANY MEANS, INCLUDING ELECTRONICALLY WITHOUT THE EXPRESSED WRITTEN CONSENT OF DAKTRONICS, INC. COPYRIGHT 2003 DAKTRONICS, INC.

DAKTRONICS, INC. BROOKINGS, SD 57006

PROJ: HANDHELD WIRELESS CAN SYSTEM

TITLE: INSERT; LL-2606, RC-100, JUDGES CONSOLE

DES. BY: GWITCHE

DRAWN BY: GWITCHE

DATE: 12 JAN 05

REVISION

APPR. BY:

00

SCALE: 1 = 1

1110-E07A-231532

REV.	DATE	DESCRIPTION	BY	APPR.

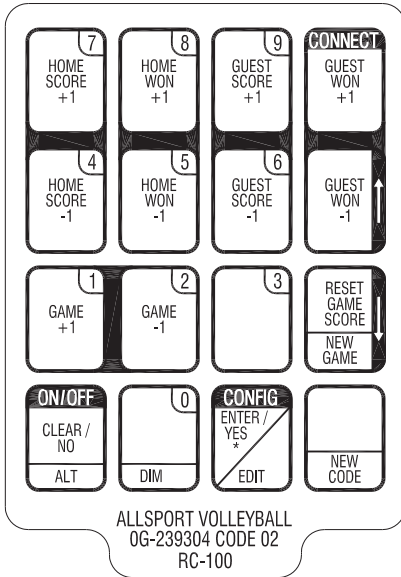

THE CONCEPTS EXPRESSED AND DETAILS SHOWN ON THIS DRAWING ARE CONFIDENTIAL AND PROPRIETARY. DO NOT REPRODUCE BY ANY MEANS, INCLUDING ELECTRONICALLY WITHOUT THE EXPRESSED WRITTEN CONSENT OF DAKTRONICS, INC. COPYRIGHT 2005 DAKTRONICS, INC.

DAKTRONICS, INC. BROOKINGS, SD 57006

PROJ:

TITLE: CUSTOM INSERT; VOLLEYBALL, RC-100

DES. BY:

DRAWN BY: GWITCHE

DATE: 14 APR 05

REVISION

APPR. BY:

00

SCALE: 1=1

1110-V07A-239304

REV.	DATE	DESCRIPTION	BY	APPR.

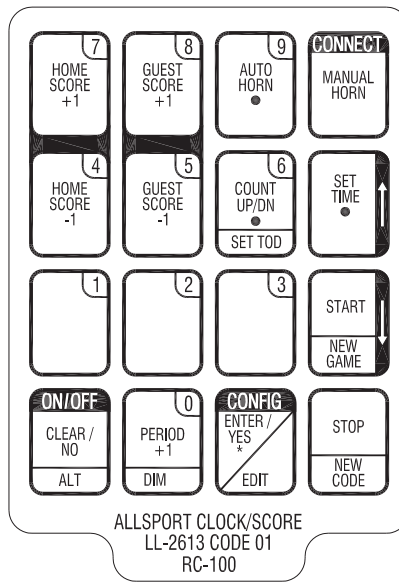

THE CONCEPTS EXPRESSED AND DETAILS SHOWN ON THIS DRAWING ARE CONFIDENTIAL AND PROPRIETARY. DO NOT REPRODUCE BY ANY MEANS, INCLUDING ELECTRONICALLY WITHOUT THE EXPRESSED WRITTEN CONSENT OF DAKTRONICS, INC. COPYRIGHT 2005 DAKTRONICS, INC.			
DAKTRONICS, INC. BROOKINGS, SD 57006			
PROJ:			
TITLE: INSERT; LL-2613, RC-100 CLOCK/SCORE			
DES. BY:		DRAWN BY: GWITCHE	
		DATE: 15 APR 05	
REVISION	APPR. BY:	1110-R07A-239307	
01	SCALE: 1=1		

01	31 MAR 06	ADDED "SET TOD" ALT FUNCTION TO 6 KEY	DJU	
REV.	DATE	DESCRIPTION	BY	APPR.

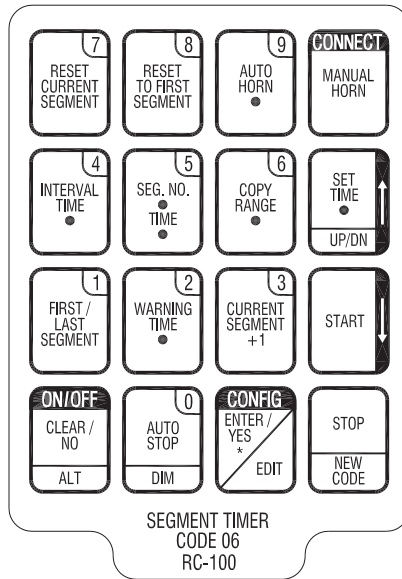

SEGMENT TIMER
CODE 06
RC-100

THE CONCEPTS EXPRESSED AND DETAILS SHOWN ON THIS DRAWING ARE CONFIDENTIAL AND PROPRIETARY. DO NOT REPRODUCE BY ANY MEANS, INCLUDING ELECTRONICALLY WITHOUT THE EXPRESSED WRITTEN CONSENT OF DAKTRONICS, INC. COPYRIGHT 2004 DAKTRONICS, INC.			
DAKTRONICS, INC. BROOKINGS, SD 57006			
PROJ: HANDHELD WIRELESS CAN SYSTEM			
TITLE: INSERT; LL-2613 BACK, RC-100 SEGMENT TIMER			
DES. BY:		DRAWN BY: DULSCHM	
		DATE: 14 JUL 05	
REVISION	APPR. BY:	1110-R07A-247621	
00	SCALE: 1 = 1		

REV.	DATE	DESCRIPTION	BY	APPR.
------	------	-------------	----	-------

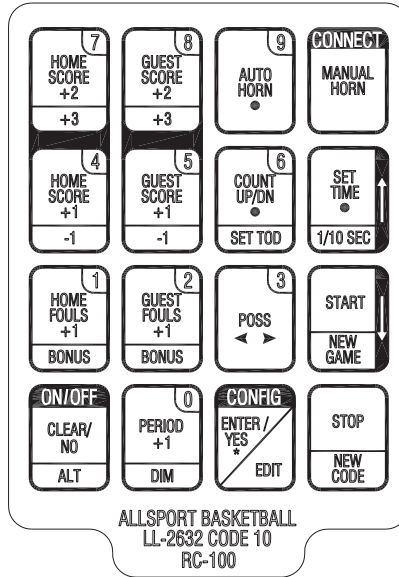

THE CONCEPTS EXPRESSED AND DETAILS SHOWN ON THIS DRAWING ARE CONFIDENTIAL AND PROPRIETARY. DO NOT REPRODUCE BY ANY MEANS, INCLUDING ELECTRONICALLY WITHOUT THE EXPRESSED WRITTEN CONSENT OF DAKTRONICS, INC. COPYRIGHT 2004 DAKTRONICS, INC.

DAKTRONICS, INC. BROOKINGS, SD 57006

PROJ: HANDHELD WIRELESS CAN SYSTEM

TITLE: INSERT; LL-2632, RC-100, BASKETBALL

DES. BY: DULSCHM

DRAWN BY: JCOSE

DATE: 29 DEC 05

REVISION
02

APPR. BY:

SCALE: 1 = 1

1110-E07A-253583

REV.	DATE	DESCRIPTION	BY	APPR.
02	31 MAY 06	ADDED NUMBER KEYS 1-9	JMC	
01	31 MAR 06	ADDED "SET TOD" ALT FUNC TO COUNT UP/DN	DJU	

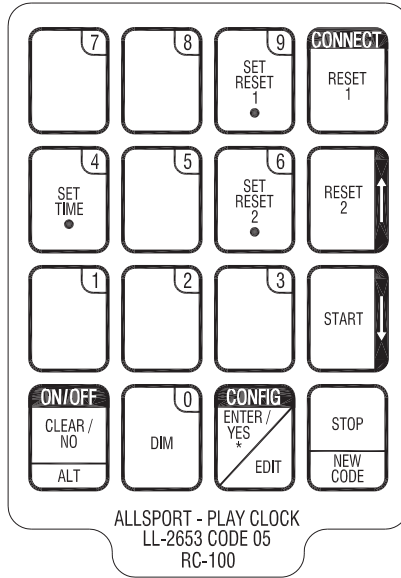

THE CONCEPTS EXPRESSED AND DETAILS SHOWN ON THIS DRAWING ARE CONFIDENTIAL AND PROPRIETARY. DO NOT REPRODUCE BY ANY MEANS, INCLUDING ELECTRONICALLY WITHOUT THE EXPRESSED WRITTEN CONSENT OF DAKTRONICS, INC. COPYRIGHT 2004 DAKTRONICS, INC.			
DAKTRONICS, INC. BROOKINGS, SD 57006			
PROJ: HANDHELD WIRELESS CAN SYSTEM			
TITLE: INSERT; LL-2653, RC-100 PLAY CLOCK			
DES. BY: DULSCHM		DRAWN BY: DULSCHM	
		DATE: 04 AUG 06	
REVISION	APPR. BY:	1110-E07A-280870	
00	SCALE: 1 = 1		

REV.	DATE	DESCRIPTION	BY	APPR.

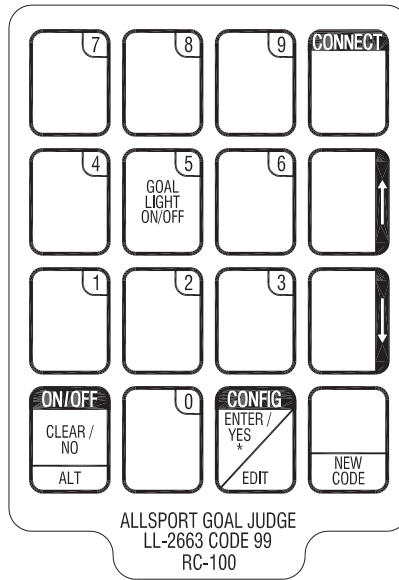

THE CONCEPTS EXPRESSED AND DETAILS SHOWN ON THIS DRAWING ARE CONFIDENTIAL AND PROPRIETARY. DO NOT REPRODUCE BY ANY MEANS, INCLUDING ELECTRONICALLY WITHOUT THE EXPRESSED WRITTEN CONSENT OF DAKTRONICS, INC. COPYRIGHT 2007 DAKTRONICS, INC.

DAKTRONICS, INC. BROOKINGS, SD 57006

PROJ:

TITLE: INSERT; LL-2663, RC-100 GOAL JUDGE

DES. BY: JCOSE

DRAWN BY: JCOSE

DATE: 08 MAR 07

REVISION

APPR. BY:

00

SCALE: 1=1

1110-R07A-298780

REV.	DATE	DESCRIPTION	BY	APPR.

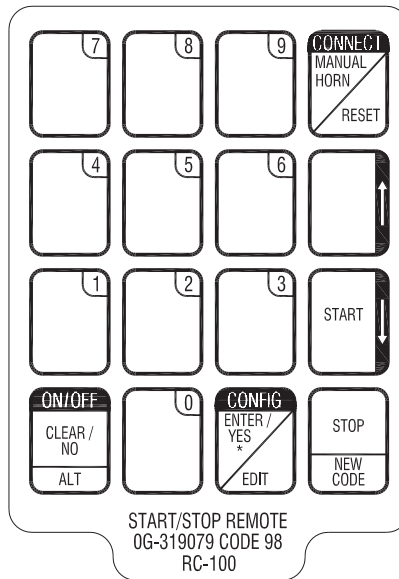

THE CONCEPTS EXPRESSED AND DETAILS SHOWN ON THIS DRAWING ARE CONFIDENTIAL AND PROPRIETARY. DO NOT REPRODUCE BY ANY MEANS, INCLUDING ELECTRONICALLY WITHOUT THE EXPRESSED WRITTEN CONSENT OF DAKTRONICS, INC. COPYRIGHT 2009 DAKTRONICS, INC.

DAKTRONICS, INC. BROOKINGS, SD 57006

PROJ:

TITLE: INSERT: CUSTOM- RC-100- START/STOP REMOTE

DES. BY: JCOSE

DRAWN BY: JCOSE

DATE: 07 AUG 07

REV.	DATE	DESCRIPTION	BY	APPR.
01	13 APR 09	ADDED RESET TO MANUAL HORN KEY	DJU	

REVISION

01

APPR. BY:

SCALE: 1=1

1110-R07A-319079

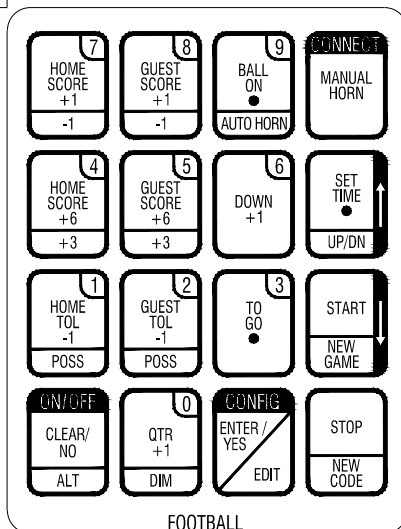

FOOTBALL
 0G-1031603 CODE 61, 62
 RC-100

	DAKTRONICS, INC.	THE CONCEPTS EXPRESSED AND DETAILS SHOWN ON THIS DRAWING ARE CONFIDENTIAL AND PROPRIETARY. DO NOT REPRODUCE BY ANY MEANS WITHOUT THE EXPRESSED WRITTEN CONSENT OF DAKTRONICS, INC. COPYRIGHT 2010 DAKTRONICS, INC.
	BROOKINGS, SD 57006	
DO NOT SCALE DRAWING		

REV 03	DATE: 25 MAR 13	ADDED CODE 62 TO DESCRIPTION	BY: DJU
REV 02	DATE: 12 NOV 10	ADDED EDIT TO ENTER KEY ADDED NO TO CLEAR KEY ADDED MANUAL TO HORN KEY	BY: DJU
REV 01	DATE: 22 SEP 10	MOVED AUTO HORN ALT FUNCTION FROM HORN KEY TO BALL ON KEY	BY: DJU

PROJ: HANDHELD WIRELESS CAN SYSTEM			
TITLE: INSERT; CUSTOM, RC-100, FOOTBALL			
DESIGN: BCARSRU	DRAWN: DULSCHM	DATE: 07 SEP 10	
SCALE: 1 = 1			
SHEET	REV 03	JOB NO: P1110	FUNC-TYPE-SIZE E-07-A
			1031603

Appendix C: Daktronics Warranty and Limitation of Liability

DAKTRONICS WARRANTY & LIMITATION OF LIABILITY

This Warranty and Limitation of Liability (the "Warranty") sets forth the warranty provided by Daktronics with respect to the Equipment. By accepting delivery of the Equipment, Purchaser and End User agree to be bound by and accept these terms and conditions. Unless otherwise defined herein, all terms within the Warranty shall have the same meaning and definition as provided elsewhere in the Agreement.

DAKTRONICS WILL ONLY BE OBLIGATED TO HONOR THE WARRANTY SET FORTH IN THESE TERMS AND CONDITIONS UPON RECEIPT OF FULL PAYMENT FOR THE EQUIPMENT.

1. Warranty Coverage

A. Daktronics warrants to the original end user (the "End User") that the Equipment will be free from Defects (as defined below) in materials and workmanship for a period of one (1) year (the "Warranty Period"). The Warranty Period shall commence on the earlier of: (i) four weeks from the date that the Equipment leaves Daktronics' facility; or (ii) Substantial Completion as defined herein. The Warranty Period shall expire on the first anniversary of the commencement date.

"Substantial Completion" means the operational availability of the Equipment to the End User in accordance with the Equipment's specifications, without regard to punch-list items, or other non-substantial items which do not affect the operation of the Equipment.

B. Daktronics' obligation under this Warranty is limited to, at Daktronics' option, replacing or repairing, any Equipment or part thereof that is found by Daktronics not to conform to the Equipment's specifications. Unless otherwise directed by Daktronics, any defective part or component shall be returned to Daktronics for repair or replacement. This Warranty does not include on-site labor charges to remove or install these components. Daktronics may, at its option, provide on-site warranty service. Daktronics shall have a reasonable period of time to make such replacements or repairs and all labor associated therewith shall be performed during regular working hours. Regular working hours are Monday through Friday between 8:00 a.m. and 5:00 p.m. at the location where labor is performed, excluding any holidays observed by Daktronics.

C. Daktronics shall pay ground transportation charges for the return of any defective component of the Equipment. All such items shall be shipped by End User DDP Daktronics designated facility. If returned Equipment is repaired or replaced under the terms of this Warranty, Daktronics will prepay ground transportation charges back to End User and shall ship such items DDP End User's designated facility; otherwise, End User shall pay transportation charges to return the Equipment back to the End User and such Equipment shall be shipped Ex Works Daktronics designated facility. All returns must be pre-approved by Daktronics before shipment. Daktronics shall not be obligated to pay freight for any unapproved return. End User shall pay any upgraded or expedited transportation charges.

D. Any replacement parts or Equipment will be new or serviceably used, comparable in function and performance to the original part or Equipment, and warranted for the remainder of the Warranty Period. Purchasing additional parts or Equipment from the Seller does not extend the Warranty Period.

E. Defects shall be defined as follows. With regard to the Equipment (excepting LEDs), a "Defect" shall refer to a material variance from the design specifications that prohibit the Equipment from operating for its intended use. With respect to LEDs, "Defects" are defined as LED pixels that cease to emit light. Unless otherwise expressly provided, this Warranty does not impose any duty or liability upon Daktronics for partial LED pixel degradation. Notwithstanding the foregoing, in no event does this Warranty include LED pixel degradation caused by UV light. This Warranty does not provide for the replacement or installation of communication methods including but not limited to, wire, fiber optic cable, conduit, trenching, or for the purpose of overcoming local site interference radio equipment substitutions.

EXCEPT AS OTHERWISE EXPRESSLY SET FORTH IN THIS WARRANTY, TO THE MAXIMUM EXTENT PERMITTED BY APPLICABLE LAW, DAKTRONICS DISCLAIMS ANY AND ALL OTHER PROMISES, REPRESENTATIONS AND WARRANTIES APPLICABLE TO THE EQUIPMENT AND REPLACES ALL OTHER WARRANTIES OR CONDITIONS, EXPRESS OR IMPLIED, INCLUDING, BUT NOT LIMITED TO, ANY IMPLIED WARRANTIES OR CONDITIONS OF MERCHANTABILITY, FITNESS FOR A PARTICULAR PURPOSE, OR ACCURACY OR QUALITY OF DATA. OTHER ORAL OR WRITTEN INFORMATION OR ADVICE GIVEN BY DAKTRONICS, ITS AGENTS OR EMPLOYEES, SHALL NOT CREATE A WARRANTY OR IN ANY WAY INCREASE THE SCOPE OF THIS LIMITED WARRANTY.

THIS LIMITED WARRANTY IS NOT TRANSFERABLE.

2. Exclusion from Warranty Coverage

This Warranty does not impose any duty or liability upon Daktronics for any:

A. damage occurring at any time, during shipment of Equipment unless otherwise provided for in the Agreement. When returning Equipment to Daktronics for repair or replacement, End User assumes all risk of loss or damage, agrees to use any shipping containers that might be provided by Daktronics, and to ship the Equipment in the manner prescribed by Daktronics;

B. damage caused by: (i) the improper handling, installation, adjustment, use, repair, or service of the Equipment, or (ii) any physical damage which includes, but is not limited to, missing, broken, or cracked components resulting from non-electrical causes; altered, scratched, or fractured electronic traces; missing or gauged solder pads; cuts or clipped wires; crushed, cracked, punctured, or bent circuit boards; or tampering with any electronic connections, provided that such damage is not caused by personnel of Daktronics or its authorized repair agents;

C. damage caused by the failure to provide a continuously suitable environment, including, but not limited to: (i) neglect or misuse; (ii) improper power including, without limitation, a failure or sudden surge of electrical power; (iii) improper air conditioning, humidity control, or other environmental conditions outside of the Equipment's technical specifications such as extreme temperatures, corrosives and metallic pollutants; or (iv) any other cause other than ordinary use;

DAKTRONICS WARRANTY & LIMITATION OF LIABILITY

D. damage caused by fire, flood, earthquake, water, wind, lightning or other natural disaster, strike, inability to obtain materials or utilities, war, terrorism, civil disturbance, or any other cause beyond Daktronics' reasonable control;

E. failure to adjust, repair or replace any item of Equipment if it would be impractical for Daktronics personnel to do so because of connection of the Equipment by mechanical or electrical means to another device not supplied by Daktronics, or the existence of general environmental conditions at the site that pose a danger to Daktronics personnel;

F. statements made about the product by any salesperson, dealer, distributor or agent, unless such statements are in a written document signed by an officer of Daktronics. Such statements as are not included in a signed writing do not constitute warranties, shall not be relied upon by End User and are not part of the contract of sale;

G. damage arising from the use of Daktronics products in any application other than the commercial and industrial applications for which they are intended, unless, upon request, such use is specifically approved in writing by Daktronics;

H. replenishment of spare parts. In the event the Equipment was purchased with a spare parts package, the parties acknowledge and agree that the spare parts package is designed to exhaust over the life of the Equipment, and as such, the replenishment of the spare parts package is not included in the scope of this Warranty;

I. security or functionality of the End User's network or systems, or anti-virus software updates;

J. performance of preventive maintenance;

K. third-party systems and other ancillary equipment, including without limitation front-end video control systems, audio systems, video processors and players, HVAC equipment, batteries and LCD screens;

L. incorporation of accessories, attachments, software or other devices not furnished by Daktronics; or

M. paint or refinishing the Equipment or furnishing material for this purpose.

3. Limitation of Liability

Daktronics shall be under no obligation to furnish continued service under this Warranty if alterations are made to the Equipment without the prior written approval of Daktronics.

It is specifically agreed that the price of the Equipment is based upon the following limitation of liability. In no event shall Daktronics (including its subsidiaries, affiliates, officers, directors, employees, or agents) be liable for any claims asserting or based on (a) loss of use of the facility or equipment; lost business, revenues, or profits; loss of goodwill; failure or increased cost of operations; loss, damage or corruption of data; loss resulting from system or service failure, malfunction, incompatibility, or breaches in system security; or (b) any special, consequential, incidental or exemplary damages arising out of or in any way connected with the Equipment or otherwise, including but not limited to damages for lost profits, cost of substitute or replacement equipment, down time, injury to property or any damages or sums paid to third parties, even if Daktronics has been advised of the possibility of such damages. The foregoing limitation of liability shall apply whether any claim is based upon principles of contract, tort or statutory duty, principles of indemnity or contribution, or otherwise.

In no event shall Daktronics be liable for loss, damage, or injury of any kind or nature arising out of or in connection with this Warranty in excess of the Purchase Price of the Equipment. The End User's remedy in any dispute under this Warranty shall be ultimately limited to the Purchase Price of the Equipment to the extent the Purchase Price has been paid.

4. Assignment of Rights

The Warranty contained herein extends only to the End User (which may be the Purchaser) of the Equipment and no attempt to extend the Warranty to any subsequent user-transferee of the Equipment shall be valid or enforceable without the express written consent of Daktronics.

5. Governing Law

The rights and obligations of the parties under this Warranty shall not be governed by the provisions of the United Nations Convention on Contracts for the International Sales of Goods of 1980. The parties consent to the application of the laws of the State of South Dakota to govern, interpret, and enforce each of the parties' rights, duties, and obligations arising from, or relating in any manner to, the subject matter of this Warranty, without regard to conflict of law principles.

6. Availability of Extended Service Agreement

For End User's protection, in addition to that afforded by the warranties set forth herein, End User may purchase extended warranty services to cover the Equipment. The Extended Service Agreement, available from Daktronics, provides for electronic parts repair and/or on-site labor for an extended period from the date of expiration of this warranty. Alternatively, an Extended Service Agreement may be purchased in conjunction with this Warranty for extended additional services. For further information, contact Daktronics Customer Service at 1-800-DAKTRONICS (1-800-325-8766).