

NEW
Pinnacle H-Groove
PATENTED DESIGN



Martin Door®



"The World's Finest, Safest Doors"™

WWW.MARTINDOOR.COM

SINCE 1936

Martin's Exclusive Patented



Steel



Can you tell the difference between Steel and Aluminum?

Martin Door® now offers a patented Steel Athena which gives the same beautiful look as aluminum but up to 40% cheaper.

Steel Athena Now Available



Aluminum

PREMIUM STEEL CORNERSTONE & GATEWAY

Pages 6 - 17

- Cornerstone: 4-Section 7' (2134) High
- Gateway: 5-Section 7' (2134) High
- 24 Gauge · Lifetime Warranty*



MARTIN STANDARD Pages 18 - 21

- 4-Section 8' (2438) High · 26 Gauge
- 5 Year Warranty



ATHENA ALL GLASS

Pages 24 - 29

- Aluminum Athena · Steel Athena
- Martin Premium Hardware
- Lifetime Warranty*



FRENCHPORTE Pages 28 - 29

- Aluminum or Steel · Martin Premium Hardware
- Lifetime Warranty*



* See manufacturer's written warranty for details and limitations.

PINNACLE
CARRIAGE HOUSE

Pages 30 - 37

- Aluminum Pinnacle • Steel Pinnacle
- Martin Premium Hardware
- Lifetime Warranty*



Pinnacle Long Panel H-Groove / Custom Windows / True Bi-Directional Ash Wood Grain Steel



163 H-Groove / Smoked Windows / True Bi-Directional Walnut Wood Grain Steel



83 / Smoked Windows / Pure White / With Antique Hardware

ELITE
CHALET & COPPER

Pages 38-51

- Composite Wood • Copper
- Martin Premium Hardware
- Lifetime Warranty*



9010D / Walnut Stained Kingwood Over Walnut Wood Grain Steel



9009 / Walnut Stained Beachwood over Walnut Wood Grain Steel



Copper / Long Panel / With Antique Hardware

CORNERSTONE

Safety, quality and durability have always been Martins first priority. This traditional door is no exception, a beautiful door built to last.



CORNERSTONE

GOLD
MEDAL
WINNER

Flush Panel (No Rib) / Walnut Wood Grain Steel

34 Steel-Framed Frosted Windows / Long Panel / Gray White / With Antique Hardware



Ribbed Panel / Terra Brown



83 Steel-Framed Smoked Windows / Grooved Panel / Walnut Wood Grain Steel

CORNERSTONE



Flush Panel (No Rib) / Desert Taupe

83 Steel-Framed Smoked Windows / Short Panel / Walnut Wood Grain Steel





Full View Long Windows Upgrade / Flush Panel (No Rib) / Bright Stainless



Dawn Windows / Short Panel / Adobe Stone

CORNERSTONE



Flush Panel (No Rib) / Sandcast Bronze / With Antique Hardware



33 Steel-Framed Smoked Windows / Long Panel / Walnut Wood Grain Steel

Legend: ∞ - Lifetime Warranty \dagger 5 - 5 Year Warranty \dagger 10 - 10 Year Warranty \dagger

PANEL STYLES

24 gauge steel. 4-section 7' [2134] high. Optional wide center style available. - ∞

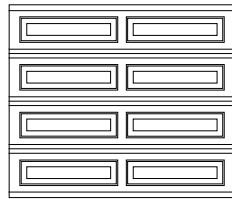

Long

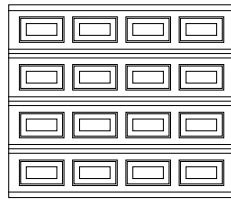

Short

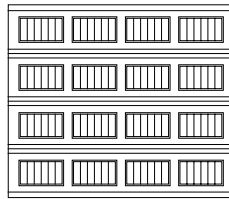

Grooved

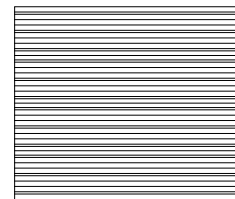

Ribbed

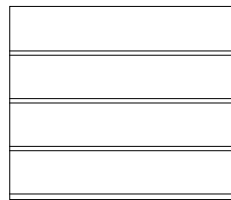

Flush \diamond (With Rib)

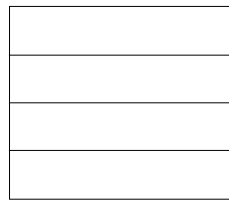

Flush \diamond (No Rib)

COLORS

Long-lasting baked-on enamel paint.

STEEL PAINT COLORS* - 10



STEEL WOOD GRAIN* - 10



POWDER COAT COLORS* \dagger - 5

[See full list of colors on page 58-59]



* Powder coated doors are insulated.

\dagger See manufacturer's written warranty for details and limitations.

\diamond Flush doors available in smooth. Call factory for details.

INSULATION

Add insulation for thermal efficiency, noise reduction, durability, and minimal upkeep.

- i2 R8** Steel + Insulation + Vinyl
- i3 R8** Steel + Insulation + Steel
- i4 R14** Steel + 2 Insulation Layers + Steel

HARDWARE

Includes roller, track and accessories for a strong and lasting door system.

(More information on page 61)

- P**

Martin Premium Hardware Package -

∞
- S**

Martin Standard Hardware Package -

5

WINDOWS

Available in acrylic or tempered glass and in Classic or Steel-Framed windows.

(See pages 54 - 55)

WINDOW TINT

Insulated glass options are available on most window types.

(See p. 52 for full tint options)

GLASS / ACRYLIC

LAMINATE

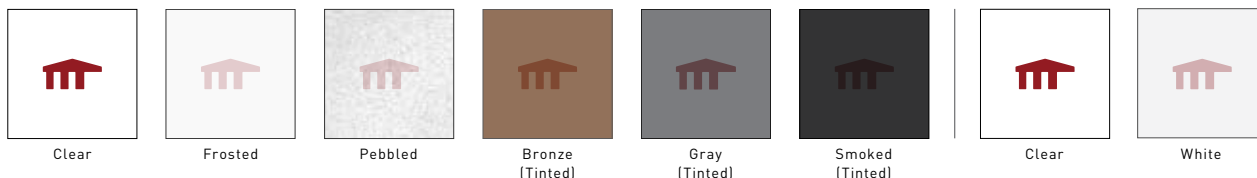

EXTRA OPTIONS

(More information on page 59)

- MAIL SLOTS
- VENTS
- INSIDE LOCK
- T-HANDLE LOCK
- VAULT RELEASE
- ANTIQUE HARDWARE

SECTION JOINT



Tongue & Groove Joint
Industry standard tongue and groove joint.



Safety Joint
Martin safety joint helps protect fingers and hands from serious injury.



Flush Panel (No Rib) / White Mist



Virginian Short Windows / Short Panel / Adobe Stone



Ribbed Panel / Oxide Red

GATEWAY

The original raised panel, uniquely designed to have larger header and footer sections. This door does not compromise.



32 Steel-Framed Smoked Windows / Long Panel / White Mist



70 Steel-Framed Smoked Windows / Long Panel / Wide Center Style / Adobe Stone





Short Panel / Wide Center Style / Black Gray / With Antique Hardware



83 Steel-Framed Smoked Windows / Short Panel / Walnut Wood Grain Steel

GATEWAY



Grooved Panel / Ash Wood Grain Steel



32 Steel-Framed Frosted Windows / Long Panel / Natural Wood Grain Steel

Legend: ∞ - Lifetime Warranty† 5 - 5 Year Warranty† 10 - 10 Year Warranty†

PANEL STYLES

5-Section (7' [2134] high) design. 24 gauge steel. Optional wide center style available. Max height is 13' 3" [4039]. - ∞

[See Gateway panel stacking guide on page 56]

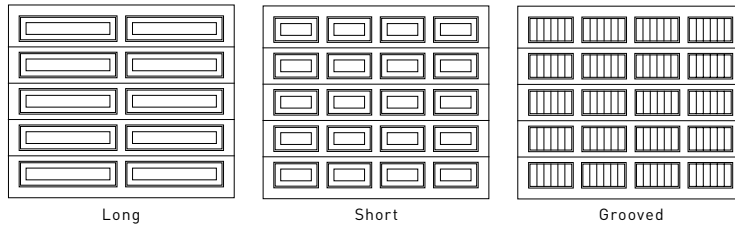

Long

Short

Grooved

COLORS

Long-lasting baked-on enamel paint.

STEEL PAINT COLORS* - 10



STEEL WOOD GRAIN* - 10



POWDER COAT COLORS*† - 5

[See full list of colors on page 58-59]



INSULATION

Add insulation for thermal efficiency, noise reduction, durability, and minimal upkeep.

i2 R8

Steel + Insulation + Vinyl

i3 R8

Steel + Insulation + Steel

i4 R14

Steel + 2 Insulation Layers + Steel

HARDWARE

Includes roller, track and accessories for a strong and lasting door system.
(More information on page 61)



Martin Premium Hardware Package - ∞



Martin Standard Hardware Package - 5

WINDOWS

Available in acrylic or tempered glass and in Classic or Steel-Framed windows.
(See pages 54 - 55)

WINDOW TINT

Insulated glass options are available on most window types.
(See p. 52 for full tint options)

GLASS / ACRYLIC



Clear



Frosted



Pebbled



Bronze
(Tinted)



Gray
(Tinted)



Smoked
(Tinted)

LAMINATE



Clear



White

EXTRA OPTIONS

(More information on page 59)

- MAIL SLOTS
- T-HANDLE LOCK
- VAULT RELEASE
- VENTS
- INSIDE LOCK
- ANTIQUE HARDWARE

SECTION JOINT

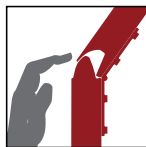

Safety Joint

Martin safety joint helps protect fingers and hands from serious injury.



Short Panel / White Mist



Virginian Short Windows / Short Panel / Desert Taupe

MARTIN STANDARD

Value priced doors with classic designs, durable and virtually maintenance free.



Short Panel / White Mist

70 Steel-Framed Smoked Windows / Grooved Panel / Desert Taupe





Grooved Panel / Adobe Stone



Canterbury Windows / Long Panel / Dark Brown

MARTIN STANDARD



Grooved Panel / Dark Brown



Short Panel / Light Almond

Legend: ∞ - Lifetime Warranty † 5 - 5 Year Warranty †

PANEL STYLES

26 gauge steel. 4-section 8' (2438) high. - 5

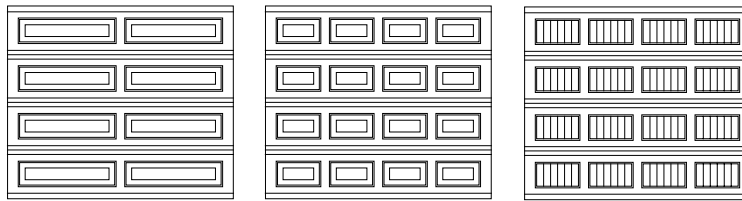

Long

Short

Grooved

(For any other Tongue & Groove joint panels, please see the commercial line)

COLORS

Long-lasting baked-on enamel paint.

STEEL PAINT COLORS - 5



White Mist

Light Almond

Dark Brown

Desert Taupe

POWDER COAT COLORS^{^†} - 5

(See full list of colors on page 58-59)



INSULATION

Add insulation for thermal efficiency, noise reduction, durability, and minimal upkeep.

i2 R8 Steel + Insulation + Vinyl





i3 R8 Steel + Insulation + Steel

i4 R14 Steel + 2 Insulation Layers + Steel

[^] Powder coated doors are insulated.
[†] See manufacturer's written warranty for details and limitations.

HARDWARE

Includes roller, track and accessories for a strong and lasting door system.
 (More information on page 61)

-  **P** Martin Premium Hardware Package - 
-  **S** Martin Standard Hardware Package - 

WINDOWS

Available in acrylic or tempered glass and in Classic or Steel-Framed windows.
 (See pages 54 - 55)

WINDOW TINT

Insulated glass options are available on most window types.
 (See p. 52 for full tint options)

GLASS / ACRYLIC

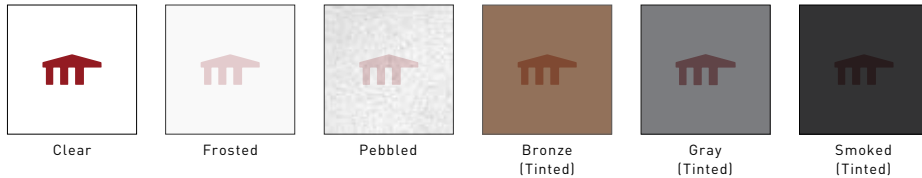

LAMINATE

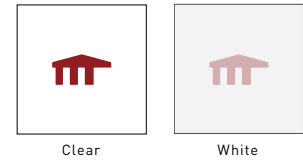

EXTRA OPTIONS

(More information on page 59)

- MAIL SLOTS
- T-HANDLE LOCK
- VAULT RELEASE
- VENTS
- INSIDE LOCK
- ANTIQUE HARDWARE

SECTION JOINT



Tongue & Groove Joint
 Industry standard tongue and groove joint.



Safety Joint
 Martin safety joint helps protect fingers and hands from serious injury.

DOOR HEIGHT EXAMPLES[^]

For heights above 8' 9" (2667) refer to door height examples on page 57.

MEASUREMENTS:

18" = 457 mm
 21" = 533 mm
 24" = 610 mm

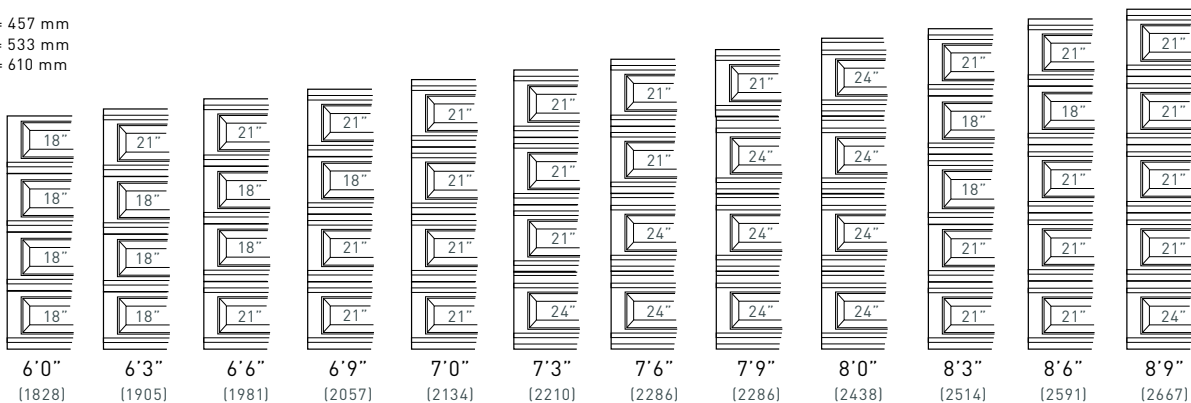

[^] Please note that the Martin Standard and the Cornerstone tongue and groove joint 8' (2438) is 4 sections vs 5 section for the 8' Safety Joint Cornerstone.

ATHENA

The modern design of glass allows natural light while providing you with security and privacy. Beauty and elegance are at your fingertips.





ALUMINUM ATHENA



211 / Clear Windows / Signal White

231 / Smoked Windows / Rusty Iron



STEEL ATHENA



232 / Smoked Windows / Bronze



231 / Frosted Windows / Sandcast Bronze

ATHENA



Legend: ∞ - Lifetime Warranty† 5 - 5 Year Warranty† 3 - 3 Year Warranty† 10 - 10 Year Warranty†

PANEL STYLES

24 gauge steel or aluminum - ∞

8' - 10'2" [2438 - 3099]

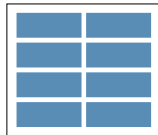

211

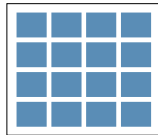

212

10'3" - 15'2" [3124 - 4623]

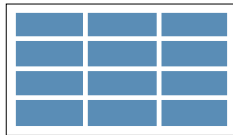

221



222

15'3" - 22' [4648 - 6706]

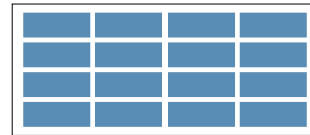

231



232

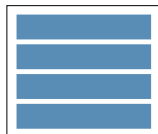

201

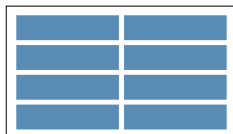

211 Wide

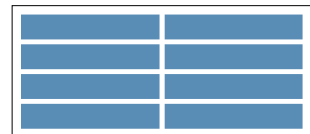

211 Wide

Available in aluminum only. (up to 16' 2" 4927)

COLORS

Long-lasting baked-on paint.

STEEL PAINT COLORS* - 10



White
Mist



Light
Almond

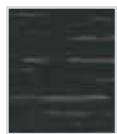

Dark
Brown



Desert
Taupe



Adobe
Stone

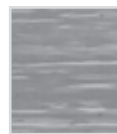

Silver

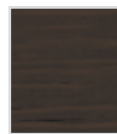

Bronze

STEEL WOOD GRAIN* - 10



Walnut



Ash



Natural

POWDER COAT FINISHES† (STEEL- 5 OR ALUMINUM- 3)

(See full list of colors on page 58-59)

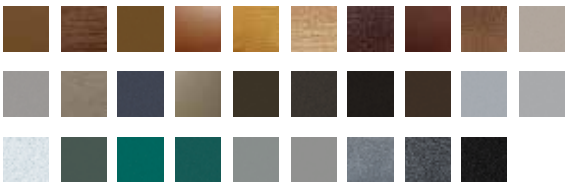

ANODIZED ALUMINUM FINISH

A natural looking, durable and corrosion-resistant finish. Other colors available upon request.



Clear



Bronze



Black

TEXTURE

Smooth or embossed textures are available on this door.

(Embossed comes standard. Smooth doors are powdercoated)



Smooth Steel



Embossed Steel



Smooth Aluminum

INSULATION

Add insulation for thermal efficiency, noise reduction, durability, and minimal upkeep.

(R-value represents rails only. Total door r-value will vary depending on glass type.)



Insulated Steel Frame Upgrade

HARDWARE

Includes roller, track and accessories for a strong and lasting door system.

(More information on page 61)



Martin Premium Hardware Package - ∞

WINDOW TINT

Insulated glass options are available on most window types.

(See p. 52 for full tint options)

GLASS / ACRYLIC



Clear



Frosted



Pebbled



Bronze
[Tinted]



Gray
[Tinted]



Smoked
[Tinted]

LAMINATE



Clear



White

EXTRA OPTIONS

(More information on page 59)

- MAIL SLOTS
- T-HANDLE LOCK
- VAULT RELEASE
- VENTS
- INSIDE LOCK
- ANTIQUE HARDWARE

SECTION JOINT



Safety Joint

Martin safety joint helps protect fingers and hands from serious injury.

FRENCHPORTE



Legend: ∞ - Lifetime Warranty† 5 - 5 Year Warranty† 3 - 3 Year Warranty† 10 - 10 Year Warranty†

PANEL STYLES

Available in aluminum only - ∞

8' - 10'2" (2438 - 3099)

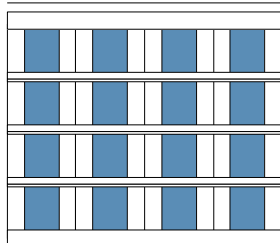

Christina

10'3" - 15'2" (3124 - 4623)

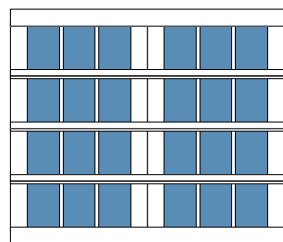
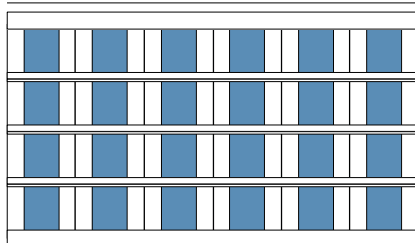

Jennifer

15'3" - 22' (4648 - 6706)

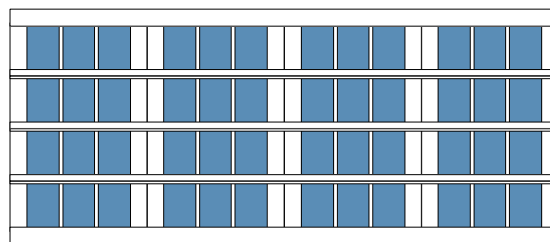
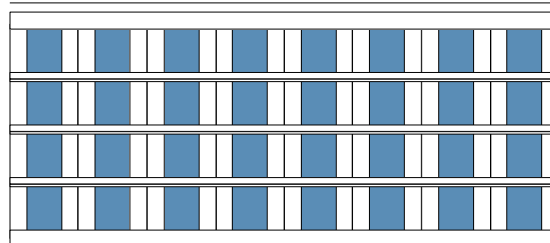

24 gauge steel or aluminum - ∞

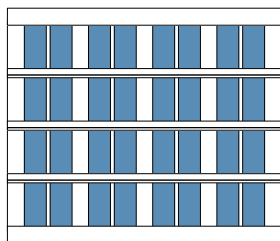

Kendra

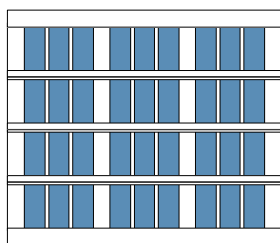
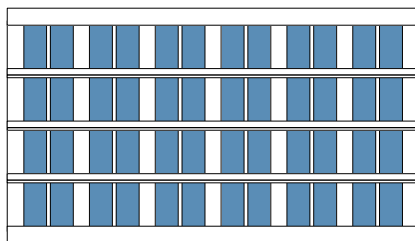

Madeleine

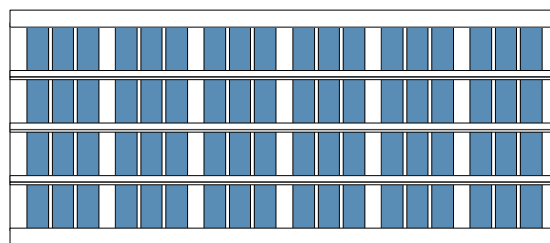
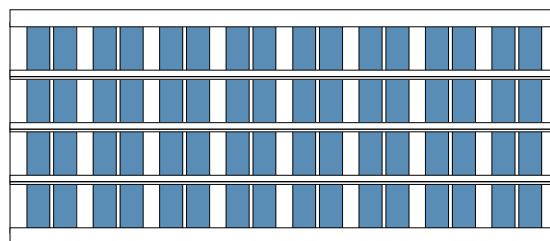
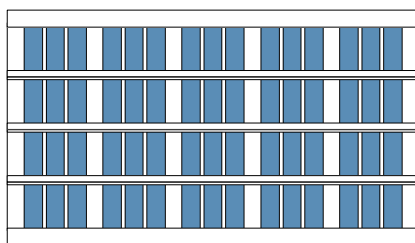

See Athena for colors, texture, insulation, hardware, and tint options.

(pages 26-27)



Jennifer / Frosted Windows / Sandcast Bronze / With Handle Hardware



Jennifer / Frosted Windows / Pure White / With Handle Hardware

ALUMINUM PINNACLE

Built like carriage house doors, but without the high maintenance associated with wood. Many stunning handmade designs to choose from.



115 / Clear Windows / Signal White

86 / Clear Windows / Gray Yellow / With Antique Hardware





63 / Clear Windows / Pure White / With Antique Hardware



66 / Smoked Windows / Rusty Iron / With Antique Hardware

STEEL PINNACLE

PATENTED DESIGN



163 / Smoked Windows / Iron Glimmer

168 / Smoked Windows / Pure White





183 V-Groove / Smoked Windows / Double Stile / True Bi-Directional Walnut Wood Grain Steel



183 V-Groove / Clear Windows / True Bi-Directional Ash Wood Grain Steel

PINNACLE



Legend: (∞) - Lifetime Warranty† (5) - 5 Year Warranty† (3) - 3 Year Warranty† (10) - 10 Year Warranty†

BASE MATERIAL

24 gauge steel or aluminum - (∞)
 (More panel styles on page 38 - 39)

STEEL COLOR OPTIONS

Long-lasting baked-on paint.
 (See full list of colors on page 58-59)

STEEL PAINT COLORS* - (10)



STEEL WOOD GRAIN* - (10)



POWDER COAT FINISHES† (STEEL- (5) OR ALUMINUM- (3))

(See full list of colors on page 58-59)



DUO-TONE FINISH OPTION

Duo-Tone finish allows you to combine two color choices on one Pinnacle door.
 Choose two complementing finishes to enhance the look of your home.

(See available finishes and full list of colors on page 58)



Ash Wood Grain & Desert Bronze

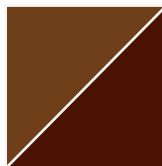

Signal Brown & Mahogany Brown



Walnut & Natural Wood Grain Steel

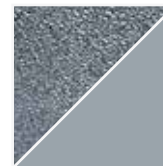

Antique Silver & Window Gray

* Available in steel only.

† See manufacturer's written warranty for details and limitations.

TEXTURE

Smooth or embossed textures are available on this door.
 (Embossed comes standard. Smooth doors are powdercoated)



Smooth Steel



Embossed Steel



Smooth Aluminum

PANEL STYLES*

24 Gauge Steel (Available in 2.5" (64) or 5" (127) groove spacing)

Long Panel

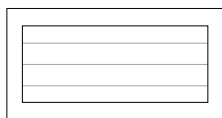

5" h-groove

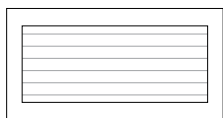

2.5" h-groove

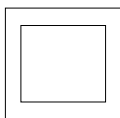

No groove

Short Panel

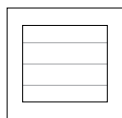

5" h-groove



2.5" h-groove

Short Panel

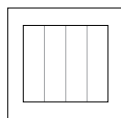

5" v-groove

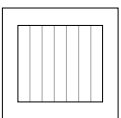

2.5" v-groove

DOUBLE CENTER STILES

Optional double center stiles are available on all H/V Groove designs. Also available with hinges, handles and clavos.

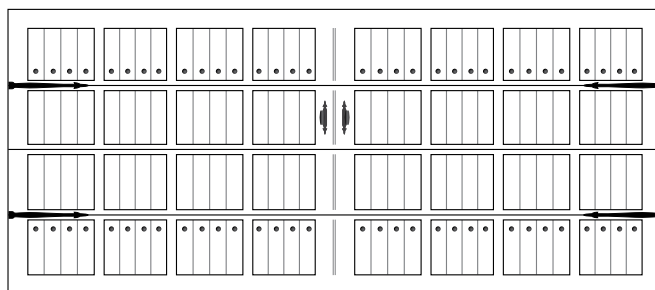

INSULATION

Add insulation with steel backing for thermal efficiency, noise reduction, durability, and minimal upkeep.



Steel +
Insulation + Steel



Aluminum +
Insulation + Steel



Insulated Steel Frame Upgrade

HARDWARE

Includes roller, track and accessories for a strong and lasting door system.



Martin Premium Hardware Package

WINDOW TINT

Insulated glass options are available on most window types.
 (See p. 52 for full tint options)

GLASS / ACRYLIC

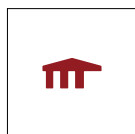

Clear



Frosted



Pebbled



Bronze
[Tinted]



Gray
[Tinted]



Smoked
[Tinted]

LAMINATE



Clear



White

EXTRA OPTIONS

(More information on page 59)

- VENTS
- VAULT RELEASE
- MAIL SLOTS
- INSIDE LOCK
- ANTIQUE HARDWARE
- T-HANDLE LOCK

SECTION JOINT



Safety Joint

Martin safety joint helps protect fingers and hands from serious injury.

PINNACLE PANEL STYLES

ALUMINUM ONLY

ALUMINUM ONLY

	8' - 10'2"	10'3" - 15'2"	15'3" - 22'	8' - 10'2"	10'3" - 15'2"	15'3" - 22'	
FULL HEIGHT							
	61	71	81	11	21	31	
	NO ARCH						
62		72	82	12	22	32	
63		73	83	13	23	33	
68		69	70	18	19	20	
64		74	84	14	24	34	
SINGLE ARCH							
		65	75	85	15	25	35
	66	76	86	16	26	36	
	67	77	87	17	27	37	
	DOUBLE ARCH						
				28	38	39	
80		90	90	30	40	40	
CHICAGO							
	8	9	10	5	6	7	

PINNACLE PANEL STYLES

ALUMINUM / STEEL / H-GROOVE

ALUMINUM / STEEL / H-GROOVE / V-GROOVE

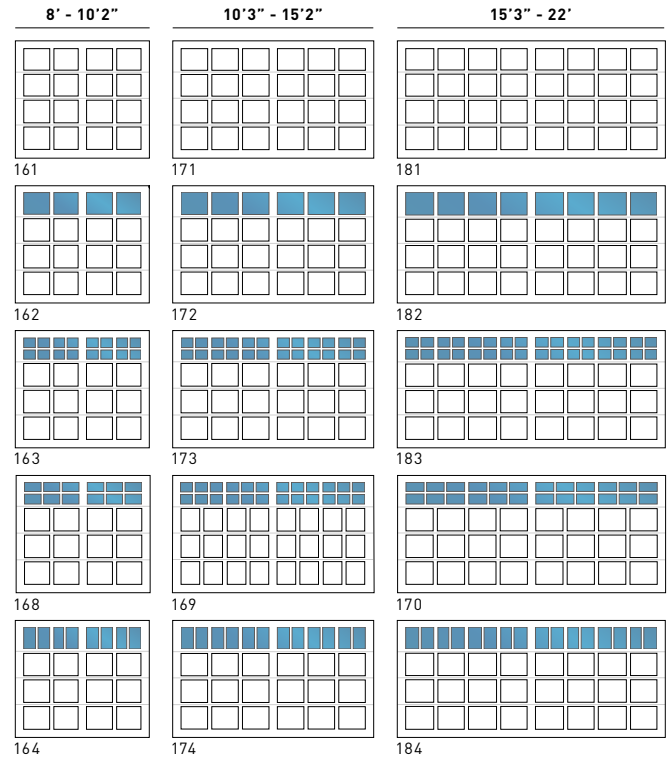

FULL HEIGHT

NO ARCH

ALUMINUM ONLY

ALUMINUM ONLY

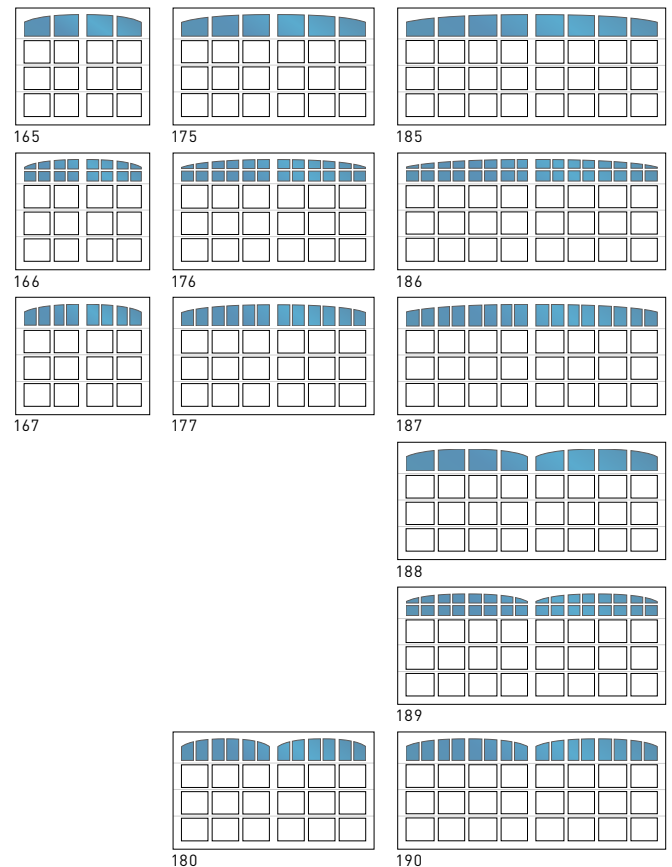
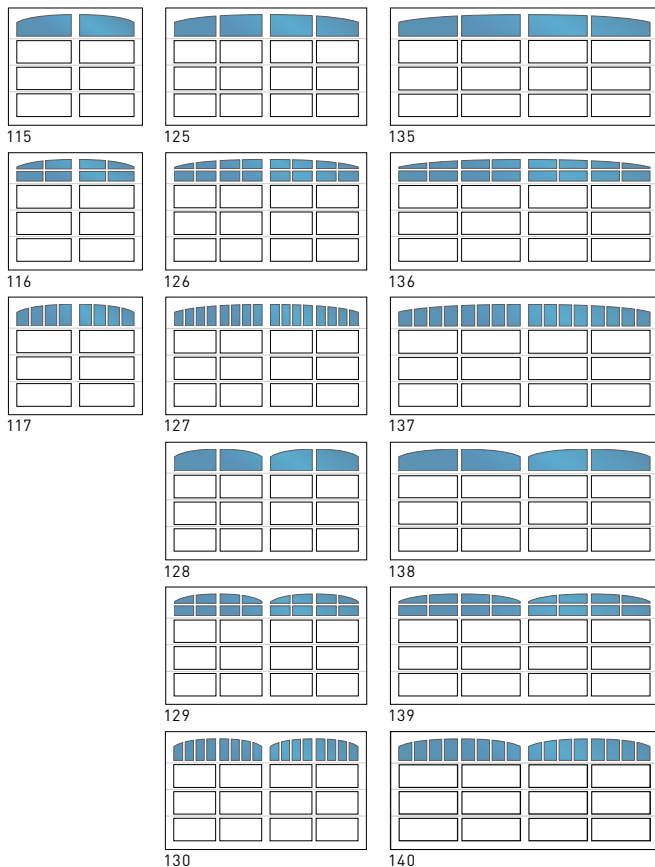

SINGLE ARCH

DOUBLE ARCH

MEASUREMENTS:

8'-10'2" widths = [2438-3099]
 10'3"-15'2" widths = [3124-4623]
 15'3"-22' widths = [4648 - 6706]

STANDARD RADIUS:

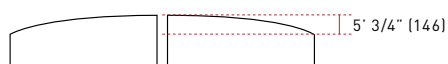

CHALET

The look and feel of our composite wood is so realistic with its natural texture and detailed wood grain you will think it's made from real wood. It's more durable and easier to maintain as well.

composite wood over composite wood





composite wood over composite wood

CHALET



9007 / 9007D / Dark Stained Kingwood

9007 / Dark Stained Beachwood over Dark Stained Kingwood / With Antique Hardware

composite wood over composite wood



composite wood over steel



9013D / Walnut Stained Kingwood over Walnut Wood Grain Steel

9013 / White Stained Kingwood over Desert Taupe Steel

composite wood over steel



CHALET



Legend: ∞ - Lifetime Warranty † 10 - 10 Year Warranty †

PANEL STYLES

24 gauge steel. - ∞
[See page 47]

WOOD COLORS

Choose between two wood species and 6 long-lasting wood stains.

WOOD STAINS - 10

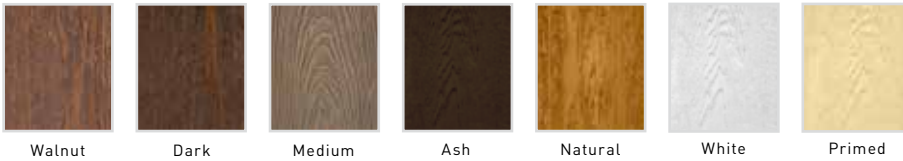

WOOD SPECIES - 10



STEEL COLOR OPTIONS

Long-lasting baked-on paint.
[See full list of colors on page 58-59]

STEEL PAINT COLORS* - 10



STEEL WOOD GRAIN* - 10



FINISH OPTIONS

Combine two color choices on one Chalet door.
Choose two complementary finishes to enhance the look of your home.
[See available finishes and full list of colors on page 58]



Composite Wood
(Medium Beachwood on
Natural Kingwood)



Composite Wood on Wood
Grain Steel
(Dark Beachwood on
Ash Steel Wood Grain)



Composite Wood on Standard Steel
(Natural Kingwood on
Adobe Stone)

* Available in steel only.

† See manufacturer's written warranty for details and limitations.

INSULATION

All doors are insulated with steel backing for thermal efficiency, noise reduction, durability, and minimal upkeep.

i4 R14 Steel + 2 Insulation Layers + Steel

i4 R18 Cladding + Steel + 2 Insulation Layers + Steel

HARDWARE

Includes roller, track and accessories for a strong and lasting door system.
(More information on page 61)

P Martin Premium Hardware Package - ∞

EXTRA OPTIONS

(More information on page 59)

- MAIL SLOTS
- VAULT RELEASE
- VENTS
- INSIDE LOCK
- ANTIQUE HARDWARE

SECTION JOINT



Safety Joint
Martin safety joint helps protect fingers and hands from serious injury.



9013 / Walnut Stained Kingwood over Walnut Stained Beachwood

CHALET



CHALET PANEL STYLES

Custom designs available upon request.

8'-10'2" (2438 - 3099)

15'3" - 22' (4648 - 6706)



9000

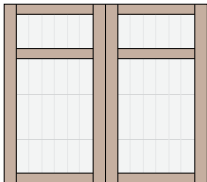

9001



9000D

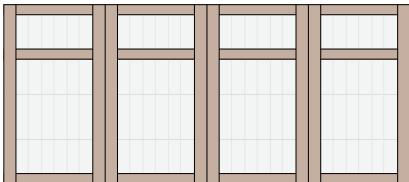

9001D

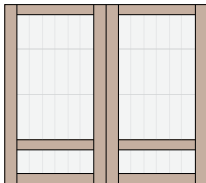

9002

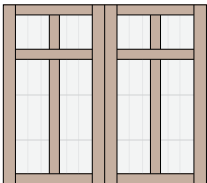

9003

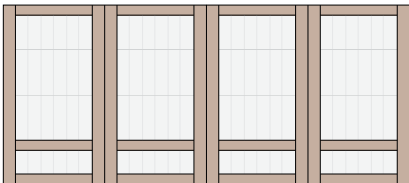

9002D

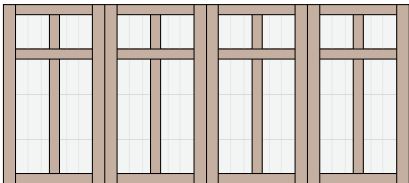

9003D

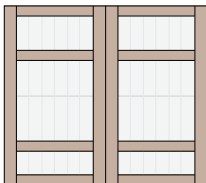

9004

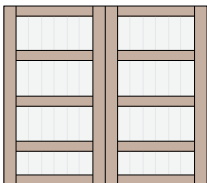

9005

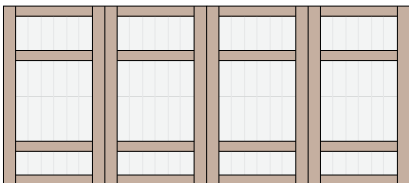

9004D

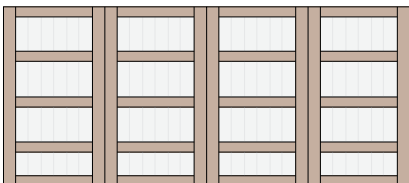

9005D

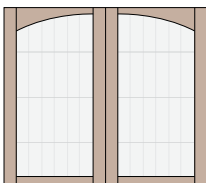

9006

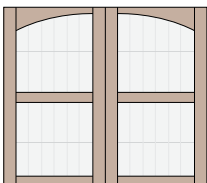

9007

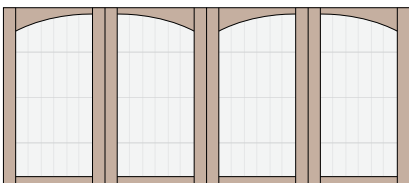

9006D

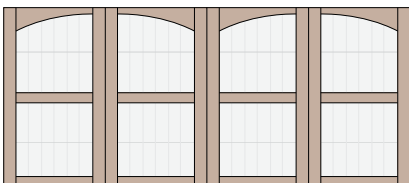

9007D

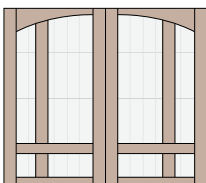

9008

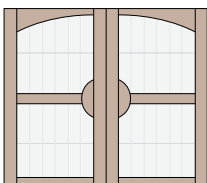

9009

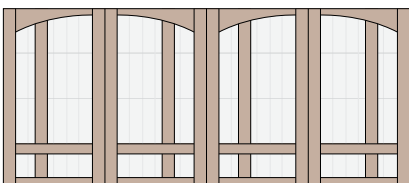

9008D

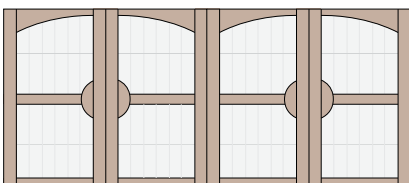

9009D

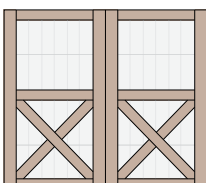

9010

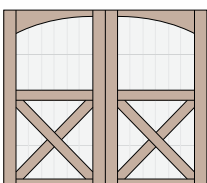

9011

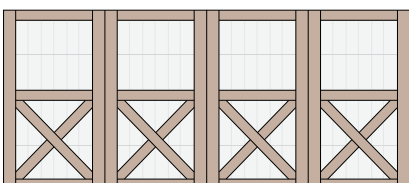

9010D

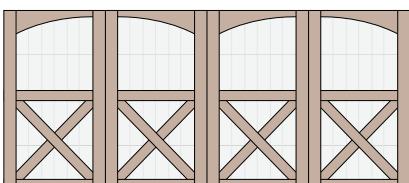

9011D

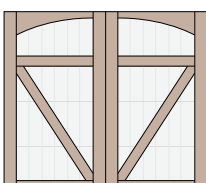

9012

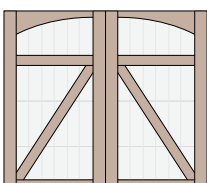

9013

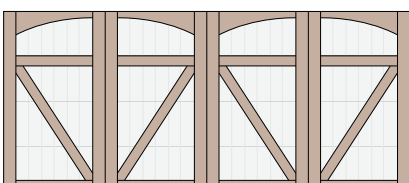

9012D

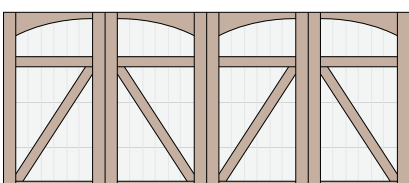

9013D

COPPER

Made from the purest copper, these unique doors offer a rare and distinctive look that will naturally patina, developing with time a breathtaking look.





COPPER

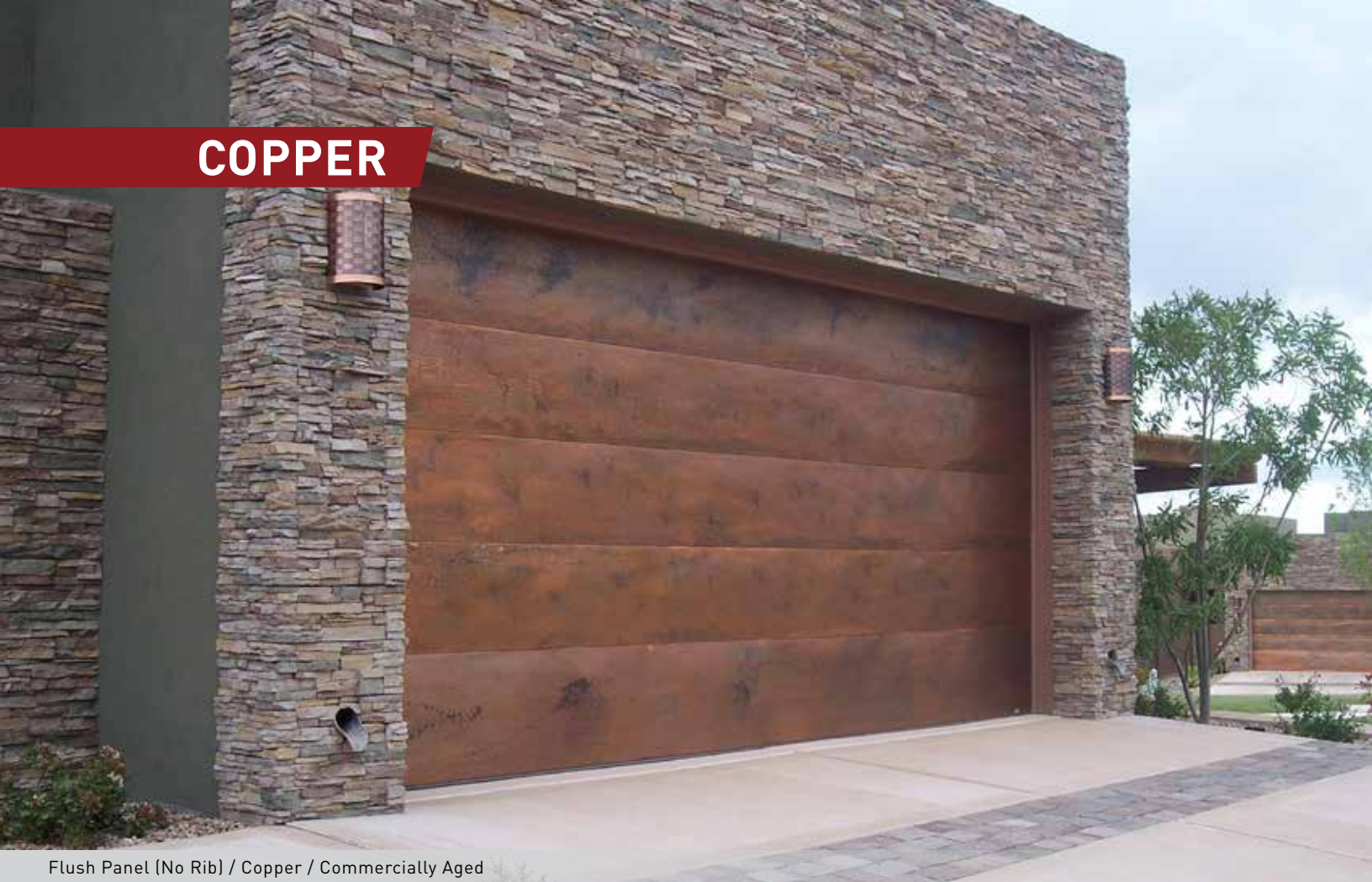

Flush Panel (No Rib) / Copper / Commercially Aged

Short Panel / Copper





Long Panel / Copper

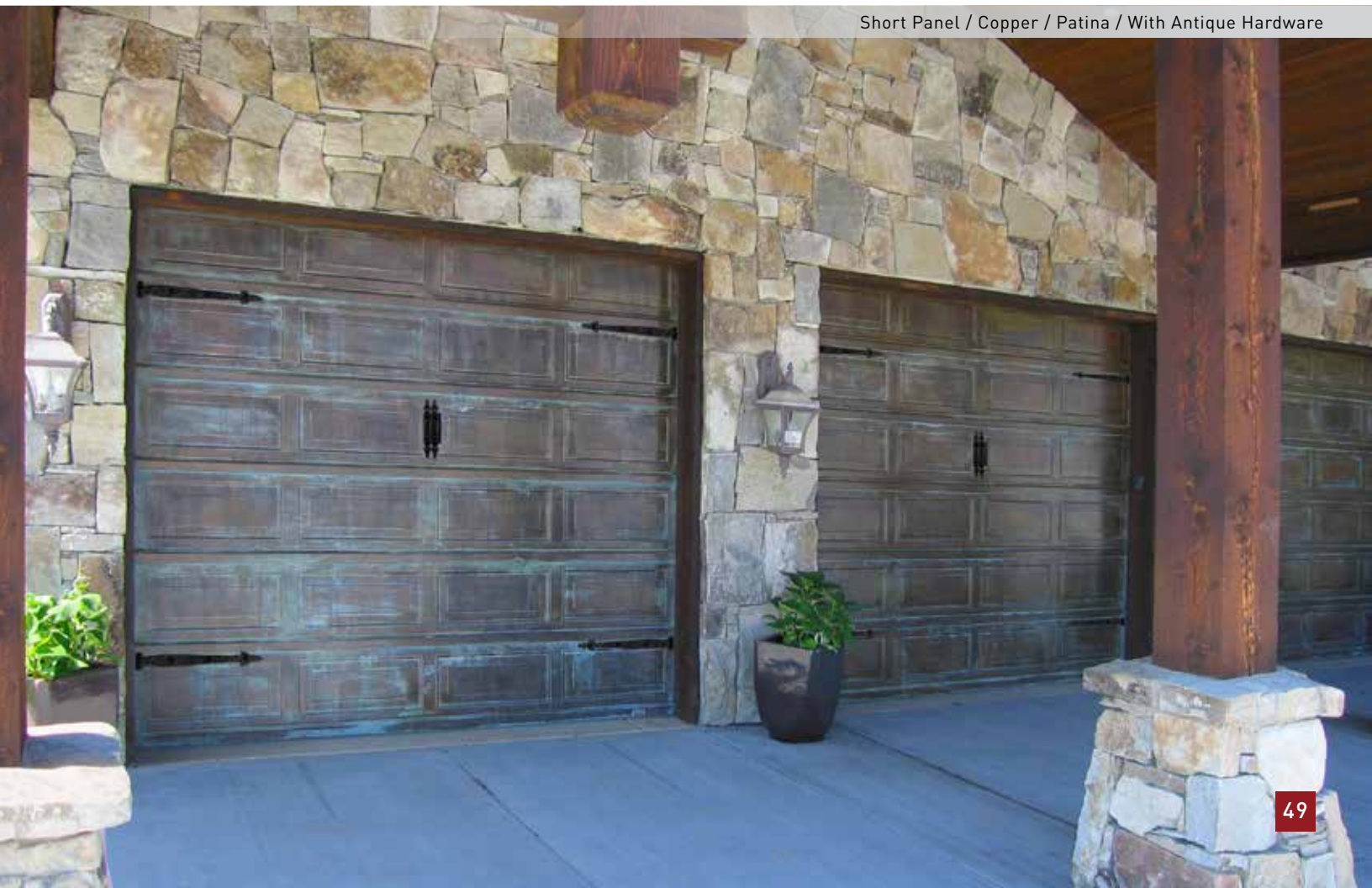

Short Panel / Copper / Patina / With Antique Hardware

COPPER



Short Panel / Copper



Dawn & Sunset Windows / Long Panel / Copper / With Antique Hardware

Legend: - Lifetime Warranty†

PANEL STYLES

99.9% Copper Metal. -

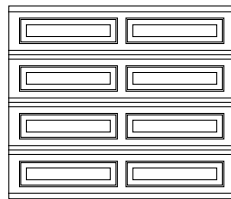

Long

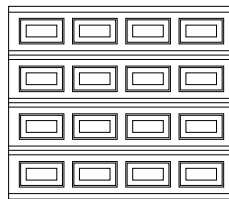

Short

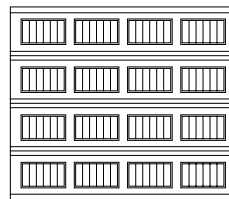

Grooved

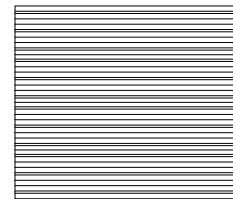

Ribbed

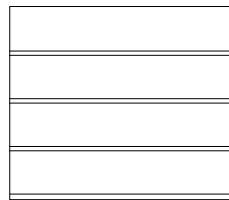

Flush (With Rib)

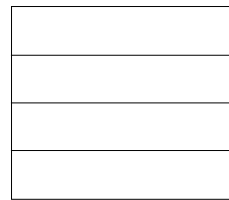

Flush (No Rib)

COLOR



99.9%
Copper Metal

Installed with new copper and in time, the copper door will naturally patina.
Patina rates will vary depending on environment.

INSULATION*

All doors are insulated with steel backing for thermal efficiency, noise reduction, durability, and minimal upkeep.

i3 R8 Copper + Insulation + Steel

i4 R14 Copper + 2 Insulation Layers + Steel

HARDWARE

Includes roller, track and accessories for a strong and lasting door system.
(More information on page 61)

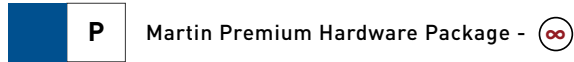

Powder Coated Hardware
All Copper model doors come with a white powder coated track and hardware.

WINDOWS

Available in acrylic or tempered glass and in Classic or Steel-Framed windows.
(See pages 54 - 55)

WINDOW TINT

Insulated glass options are available on most window types.
(See p. 52 for full tint options)

GLASS / ACRYLIC



Clear



Frosted



Pebbled



Bronze
(Tinted)



Gray
(Tinted)



Smoked
(Tinted)

LAMINATE



Clear



White

EXTRA OPTIONS

(More information on page 59)

- MAIL SLOTS
- T-HANDLE LOCK
- VENTS
- VAULT RELEASE
- INSIDE LOCK
- ANTIQUE HARDWARE

SECTION JOINT



Safety Joint
Martin safety joint helps protect fingers and hands from serious injury.



Short Panel / Copper



Long Panel / Copper



Flush Panel (With Rib) / Copper

PATENTED DESIGN

STEEL-FRAMED WINDOWS

Martin's innovative window design provides proper wood grain direction and exact color match on these hand crafted sections.

8' - 10'2" (2438 - 3099)	10'3" - 15'2" (3124 - 4623)	15'3" - 22' (4648 - 6706)
12	22	32
13	23	33
14	24	34
62	72	82
63	73	83
64	74	84
68	69	70

WINDOW OPTIONS

WINDOW HEIGHT
15" - 30" (381 - 762)

15" (381)

30" (762)

CENTER STYLE WIDTH
3" - 7" (76 - 177)

Which one would you choose?



WINDOW TINT & LAMINATE OPTIONS

(Simulated color. In some cases glass tint is lighter than acrylic tint.)

Glass / Acrylic		Laminated	
Smoked		Gray	
Clear		Bronze	
Frosted		Grays	

Comes clear or opaque.

INSULATED WINDOW OPTIONS

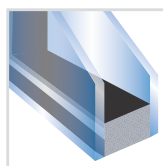

INSULATED GLASS

Upgrade your Steel-Framed windows with insulated glass.

CLASSIC WINDOWS[◇]

Old School but not forgotten, Martin Classic Windows come in a variety of beautiful choices.



Virginia Short



Virginia Long



Oxford



Nottingham



Victoria



Lancaster



Roxbury



Canterbury



Starcross



Sherwood Short



Sherwood Long



Horizon



Sunrise



Sunset*



Hampshire



Brentwood*



Banbury*



Newbury



Full View Short



Full View Long



Mediterranean Long



Mediterranean Short



Cathedral



Dawn* (16' - 20' Widths) (4876 - 6096)



Dawn-3 (15' Width) (4572)



Dawn-6 (12' - 15' Widths) (3658 - 4572)



Monterrey*



Madison*

* Not available in 12'-15' (3658-4572) widths.

◇ Not all panel styles allow for windows. Choose Steel-framed windows for exact color match.

DOUBLE PANE



Upgrade your Classic Windows with an acrylic double pane option.

Double Pane Window adds additional sound reduction and is ideal for hot or cold climates.

INSULATION

Insulation increases thermal efficiency, helps decrease noise levels and improves the appearance of the door interior. Choose steel backed insulation for durability and minimal upkeep.

ATHENA & PINNACLE

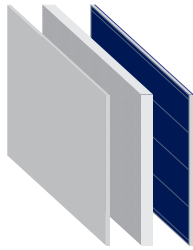

Pinnacle Panels
Polystyrene insulation with heavy-gauge color-matched steel backing.

iF **R14** ◊

Athena & Pinnacle Rails
Polyurethane insulated rails.

CHALET

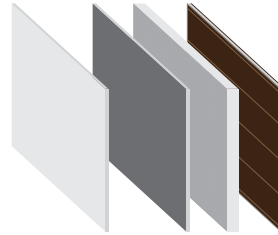

i4 **R14** i4 **R18**

(Cladding) + Steel + 2 Insulation Layers + Steel

1-layer of polystyrene and 1-layer of thermal insulation.

CORNERSTONE, GATEWAY & STANDARD



N1

Steel

2" (51) Thick door construction.

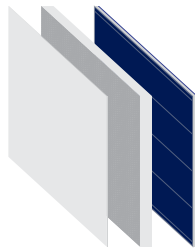

i2 **R8**

Steel + Insulation + Vinyl

Polystyrene insulation with vinyl paneled backing.

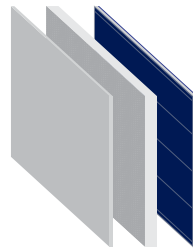

i3 **R8**

Steel + Insulation + Steel

Polystyrene insulation with heavy-gauge steel paneled backing.

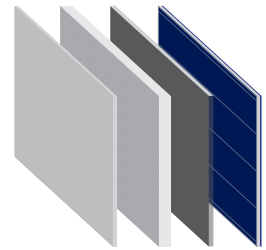

i4 **R14**

Steel + 2 Insulation Layers + Steel

1-layer of polystyrene and 1-layer of thermal insulation.

PROTECTIVE SYSTEM

Martin Multi-layered baked-on enamel paint ensures superior corrosion resistance and a durable finish.

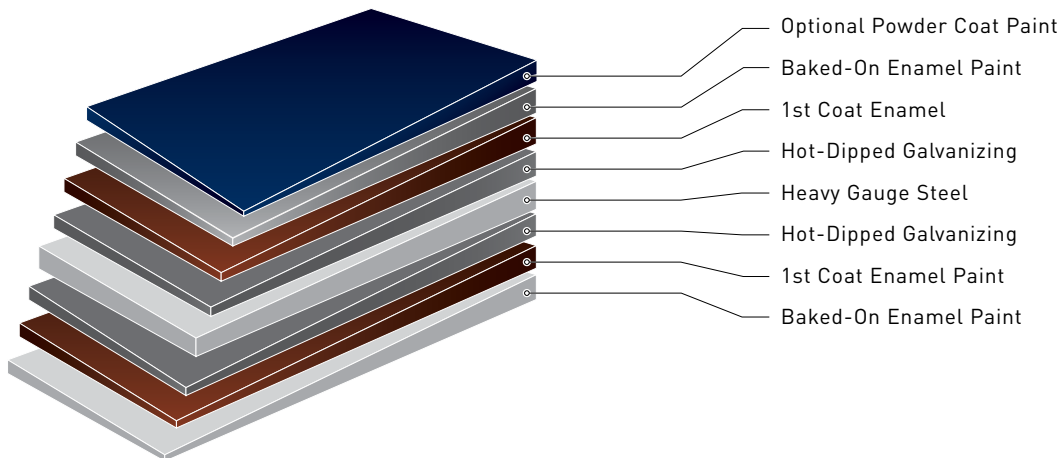

DOOR HEIGHT EXAMPLES

For Safety Joint Cornerstone and Copper doors up to 20' (6096). (See Page 21 for Tongue and Groove Joint)

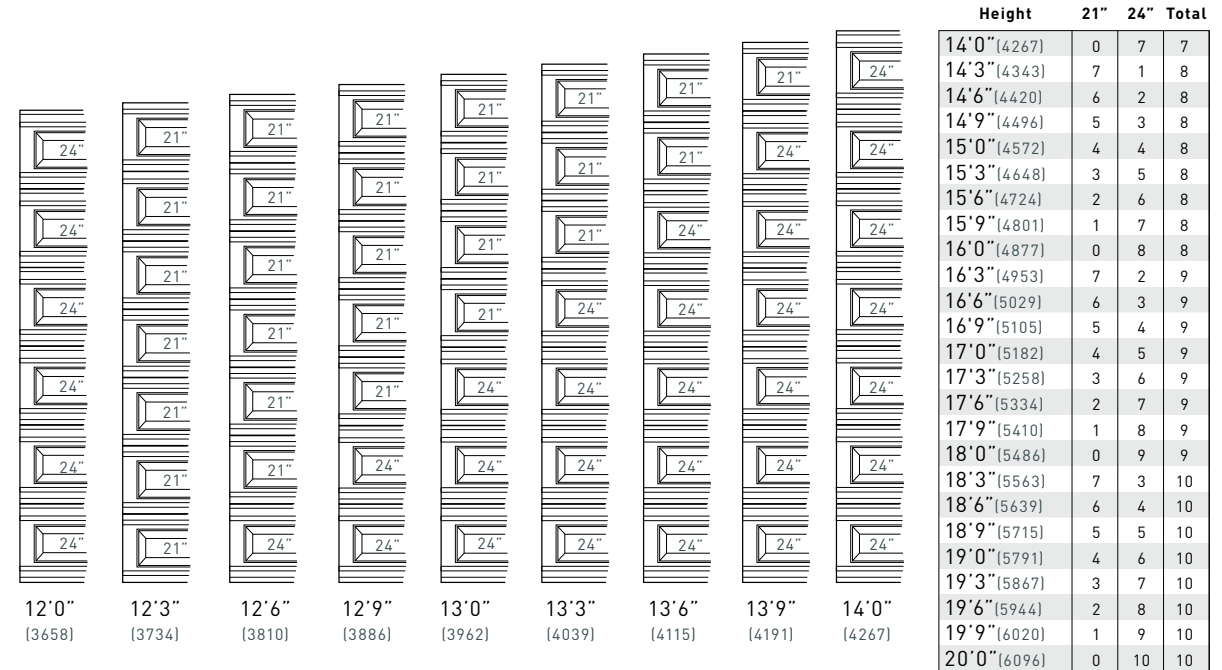
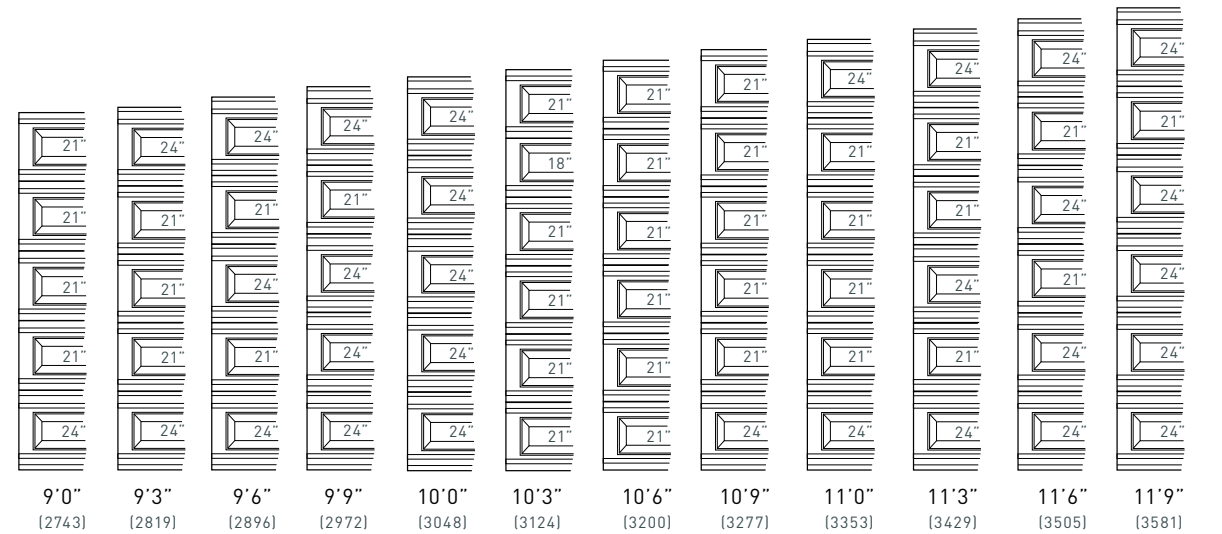
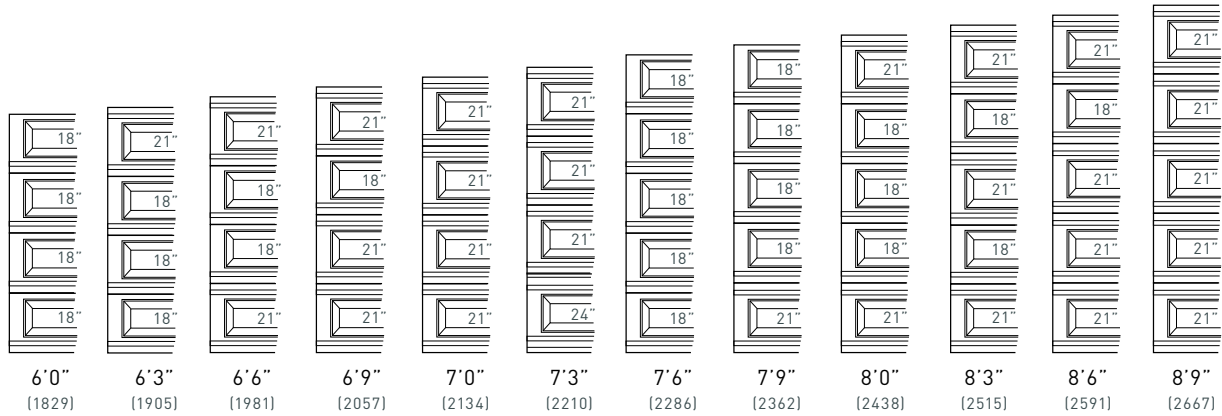

MEASUREMENTS:

18" = 457 mm
 21" = 533 mm
 24" = 610 mm

GATEWAY PANEL STACKING GUIDE

On some heights the Gateway has a larger header and footer sections that completes this unique look. The Gateway stacking has a max height of 13'3" (4039).

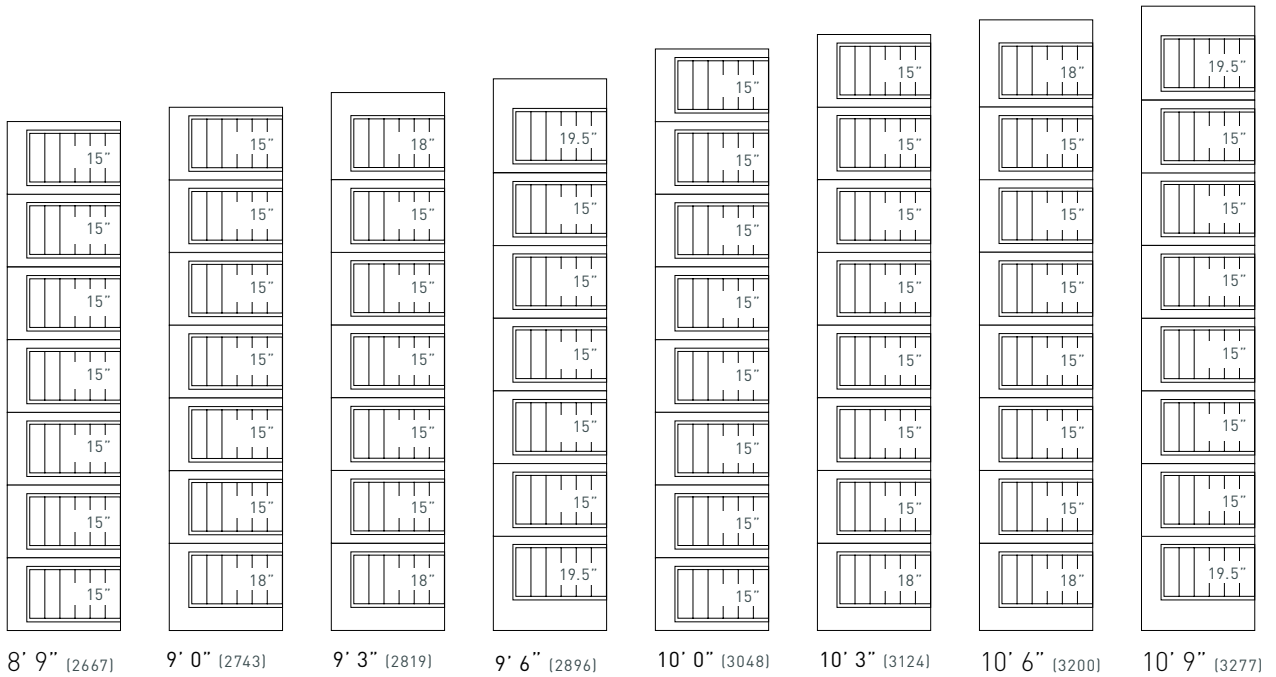
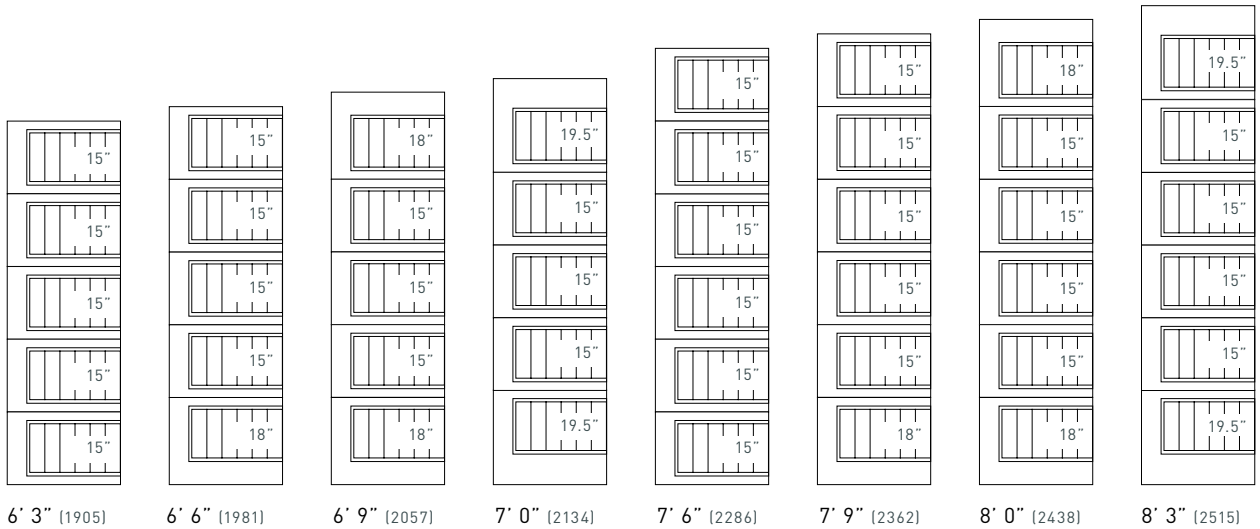

MEASUREMENTS:

- 15" = 381 mm
- 18" = 457 mm
- 19.5" = 495 mm

ADDITIONAL OPTIONS

DOOR ACCESSORIES

Customized features make Martin Garage Doors a unique and individualized door. Martin's many unique options and security features bring style and functionality to any door.



Mail Slots
Available in brass or brushed aluminum.
*Cannot be painted.



Vents
Color matched with the rest of the door.



Outside T-Handle Lock
Chrome, brass or black.



Inside Side Latch Lock
(Padlock Not Included)



Vault Release
Allows you to open and close the door during power outage.

HARDWARE KIT

Beautiful matching hinges and handles add a touch charm to your garage door. Can be powder coated.

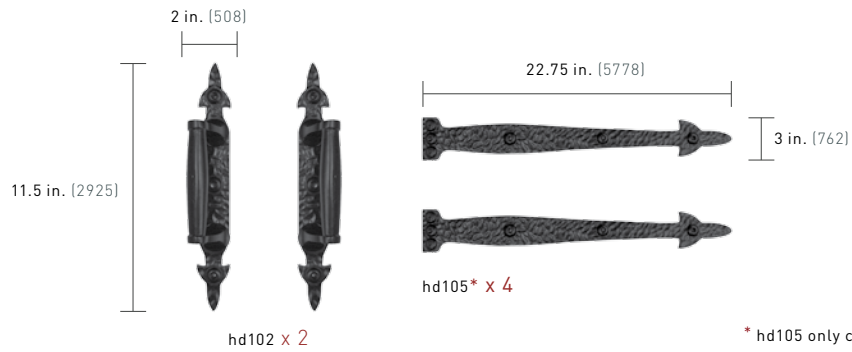

Pinnacle 183 / True Bi-Directional Walnut Wood Grain Steel

POWDER COAT FINISHES

Martin's powder coat finishes are long-lasting and durable.

SOLID

						
Sapphire Blue RAL 5003	Azure Blue RAL 5009	Pigeon Blue RAL 5014	Dark Brown CS 0003	Beige Gray RAL 7006	Desert Taupe CS 0005	Stone Gray RAL 7030
						
Silk Gray RAL 7044	Platinum Gray RAL 7036	Telegray 4 RAL 7047	Signal Red RAL 3001	Wine Red RAL 3005	Jet Black RAL 9005	Black Gray RAL 7021
						
Slate Gray RAL 7015	Basalt Gray RAL 7012	Window Gray RAL 7040	White Mist CS 0001	Traffic White RAL 9016	Signal White RAL 9003	Brown Red RAL 3011
						
Oxide Red RAL 3009	Red Brown RAL 8012	Signal Brown RAL 8002	Copper Brown RAL 8004	Beige Red RAL 3012	Beige RAL 1001	Light Ivory RAL 1015
						
Oyster White RAL 1013	Pure White RAL 9010	Fir Green RAL 6009	Brown Green RAL 6008	Black Green RAL 6012	Moss Green RAL 6005	Pine Green RAL 6028
						
Dark Chocolate CS 3070	Mahogany Brown RAL 8016	Terra Brown RAL 8028	Pale Brown RAL 8025	Adobe Stone CS 0004	Gray Yellow RAL 1019	Tarpaulin Gray RAL 7010
						
Mouse Gray RAL 7005	Reed Green RAL 6013	Cement Gray RAL 7033	Moss Gray RAL 7003	Pebble Gray RAL 7032	Light Almond CS 0002	Gray White RAL 9002

POWDER COAT FINISHES

Martin's textured metallic powder coat finishes are long-lasting and durable.

METALLIC



Walnut Vein
CS 3040



Mahogany Vein
CS 3050



Rusty Iron
CS 2005



New Copper
CS 2015



Olive Bronze
CS 3025



Redwood
CS 3065



Cherry Wood
CS 3060



Corten
CS 4025



Copper Vein
CS 2010



Copper Gold
CS 3030

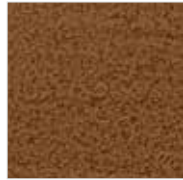

Mesquite
CS 3055



Bronze
CS 4030



Oak Stone
CS 1055



Tanzanite Metallic
CS 4020



Golden Oak
CS 3035



Red Pine
CS 3045



Sandcast Bronze
CS 3020



Bronze Metallic
CS 3015



Sage Metallic
CS 4005



Patina Green
CS 4010



Emerald Metallic
CS 4015



Starlite Granite
CS 1005

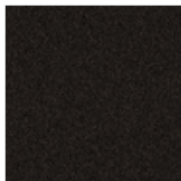

Desert Bronze
CS 3010

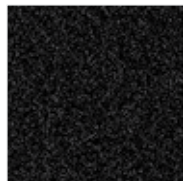

Weathered Iron
CS 1975



Silver Shadow
CS 1985



Antique Silver
CS 1980



Metallic Aluminum
CS 1035



Bright Stainless
CS 1030



Iron Glimmer
CS 1045



Ironstone Metallic
CS 1050



Metallic Pewter
CS 1040



Champagne Metallic
CS 3005

Available in high / low gloss.

Color samples will vary due to printer's color adjustments. For color accuracy see actual color chips.

All steel and copper doors have an embossed texture, unless ordered smooth.

Aluminum doors are smooth.

Insulation is required on powder coated doors.

COMPARISON CHART

	Premium Steel		Martin Standard	Elite		Athena	Pinnacle
	Cornerstone	Gateway		Chalet	Copper		
Material							
High Tensile Steel	■	■	■	■		■	■
Steel + Wood Composite Overlay				■			
Extruded Aluminum						■	■
Copper					■		
Panels							
Short, Long, Grooved	■	■	■		■		
Ribbed	■				■		
Flush	■				■		
Special				■		■	■
Number of Sections to 7'							
4-Section	■		■		■		
5-Section		■					
Varies				■		■	■
Stiles							
Standard	■	■	■		■		
Wide	■	■			■		
Varies				■		■	■
Steel Windows							
Acrylic or Tempered Glass	■	■	■		■	■	■
Insulated Glass	■	■	■		■	■	■
Laminated Glass	■	■	■		■	■	■
Classic Windows							
Acrylic or Tempered Glass	■	■	■		■		
Double Pane	■	■	■		■		
Gauge							
Steel - 26			■				
Steel - 24	■	■		■		■	■
Copper - 23					■		
Aluminum - 14						■	■
Color Options							
White Mist, Lt. Almond, Dk. Brown, Dsr. Taupe	■	■	■	■		■	■
Adobe Stone, Silver, Bronze	■	■		■		■	■
Powder Coat	■	■	■			■	■
Walnut, Ash, Natural Wood Grain Steel	■	■		■		■	■
Dark, Medium, White, Primed Wood Stains				■			
Insulation Value							
R8	■	■	■		■		
R14	■	■	■	■	■		
R18				■			
Varies						■	■
Warranty[†]							
Lifetime Section & Parts	■	■		■	■	■	■
5 Year Warranty Section & Parts*			■				
5 Year Delamination Warranty				■			
Hardware, Hinges, Track & Roller							
Martin Standard Hardware Package	■	■	■				
Martin Premium Hardware Package	■	■	■	■	■	■	■
Galvanized Springs							
	■	■	■	■	■	■	■
Safety Joint							
	■	■	■	■	■	■	■
Tongue & Groove Joint							
	■	■	■				

[†] See manufacturer's written warranty for details and limitations. Limited warranty in some environments, climates, coastlines and all of Hawaii and Middle East region. Powder coat warranty on steel is 5 years. Powder coat warranty on aluminum is 3 years. Steel-Framed Windows warranty is 10 years except Copper & Martin Standard which are 5 years. Classic Windows warranty is 3 years. 10 year paint warranty excluding Martin Standard, which is 5 years.

* Martin Standard can be upgraded to premium hardware, which comes with a lifetime warranty.

HARDWARE

Martin's hardware is long lasting, corrosion resistant, and has better safety features than industry standard.

Spring

Center-mount springs have a high risk of explosive discharge due to spring torque. Martin's side-mounted Safety Spring system helps prevent accidents from happening. Side or center-mount springs are available on all doors.

Track & Roller

Martin hardware comes with hemmed edges and reduced holes size to help prevent injury. Martin rollers have 11 sealed ball bearings, and are pre-lubricated for smooth use. Roller shields are used for additional finger safety.

Hinge

Martin's low-profile safety hinge used on all doors reduces the gap between sections.

Lift Cable

Martin's thicker 1/8" (3mm) cable protects from breakage, making your door safer.

INDUSTRY STANDARD



- ⊖ Oil-tempered spring
- ⊖ 5,000 - 10,000 life cycle

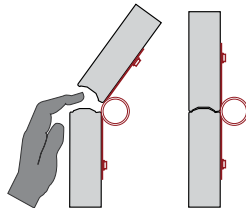

- ⊖ 3/32" (2.4mm) thick
- ⊖ No loop protection

! WARNING
INJURY OR DEATH

MARTIN STANDARD



- ⊖ Galvanized Springs
- ⊖ 15,000 life cycle

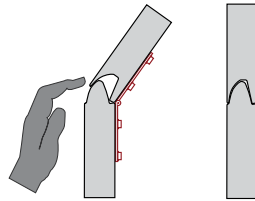

- ⊖ 1/8" (3mm) thick
- ⊖ 2000 lbs. lift capacity
- ⊖ Extra loop protection

5 Year Warranty

MARTIN PREMIUM



- ⊖ Galvanized Springs
- ⊖ 30,000 life cycle

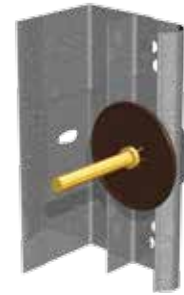

- ⊖ 16 Gauge Steel
- ⊖ Reverse Angle

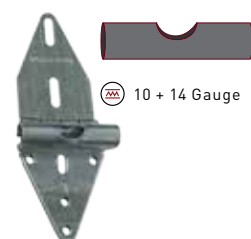
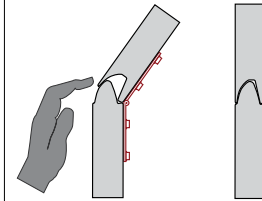

- ⊖ 1/8" (3mm) thick
- ⊖ 2000 lbs. lift capacity
- ⊖ Extra loop protection

Lifetime Warranty*

* See manufacturer's written warranty for details and limitations.

† Some doors require only one spring due to weight.

MARTIN ADVANTAGE

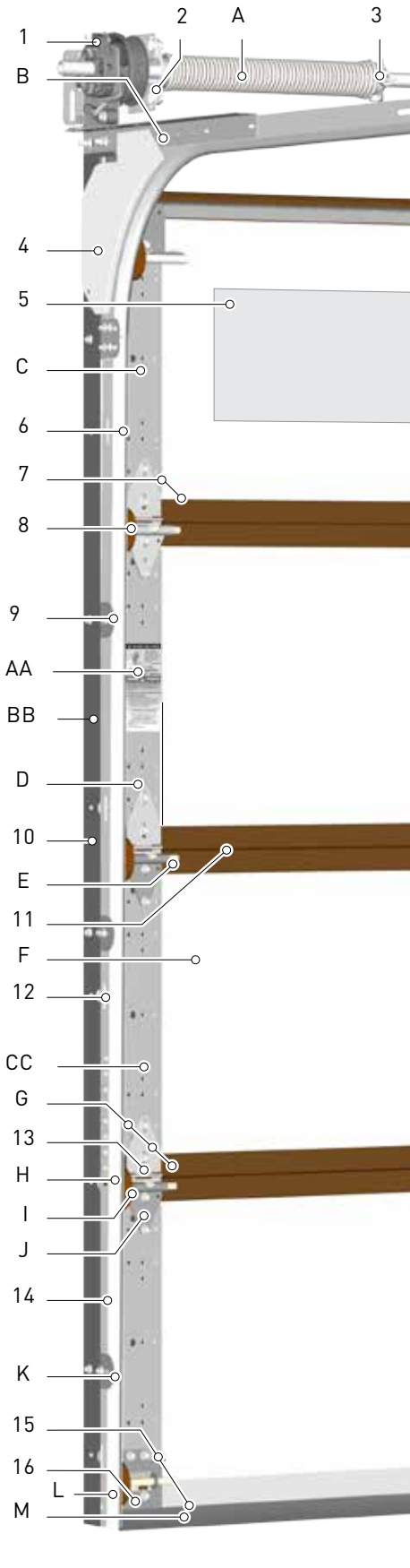

How do other garage doors compare to Martin?

◀ These upgrades are included on most Martin garage doors, and are usually an up-charge or not included at all on companies doors.

Safety		Martin	Others
Items that help protect you from injury			
1.	Controlled Descent Device [†]	✓	—
2.	Side Spring Anchor Bracket	✓	—
3.	Safety Set Screws	✓	—
4.	Curve Shields [†]	✓	—
5.	Acrylic Panes for Windows	✓	✓
6.	Rolled Edges on Tracks	✓	—
7.	Rolled Edges, Stiles / Sections	✓	—
8.	Roller Shields ^{TM†}	✓	—
9.	Round Corners on Brackets	✓	—
10.	Rolled Edge Rev. Angle Shields [†]	✓	—
11.	Safer Joint [†]	✓	—
12.	Reduced Hole Sizes in Tracks	✓	—
13.	Low Profile Safety Hinges	✓	—
14.	Concealed Lift Cables	✓	—
15.	De-burred Steel Parts	✓	—
16.	Lock-on Bottom Roller Brackets	✓	—
Long Life			
A.	Two Galvanized Torsion Springs [†]	✓	—
B.	Hot-Dip Galvanized Steel	✓	—
C.	Extruded Holes For Fastening Screws	✓	—
D.	Hardened Fasteners	✓	—
E.	Longer Stem Rollers [†]	✓	—
F.	Minimum Four Sections High	✓	✓
G.	3-Layer Hinge, Stile, Section Fastening	✓	—
H.	Higher Wind Load Ratings [†]	✓	—
I.	Sealed Bearing Nylon Rollers [†]	✓	—
J.	Commercial Grade Roller Brackets [†]	✓	—
K.	Self-Adjusting Lift Cables	✓	—
L.	Hardware Tested to 100,000 Cycles [†]	✓	—
M.	Full Length Bottom Reinforcing Angle	✓	—
Convenience			
AA.	Home Owners Information	✓	—
BB.	Dry Wall Mount Certified [†]	✓	—
CC.	2" Wider Door Provides Weather-seal	✓	—

* Not applicable on Martin Standard

† Optional upgrade on some models

INDUSTRY STANDARD GARAGE DOORS ARE DANGEROUS

Martin protects children and adults from serious injuries and death.

COMMON INJURIES - PER YEAR*			
Finger crushing, dislocation, amputation or death			
Snow Blowers	Push Mowers	Garbage Disposals	Garage Doors
			15,259
			9,275

*According to a recent report from the Consumer Product Safety Commission NEISS survey.

Industry Standard Joint

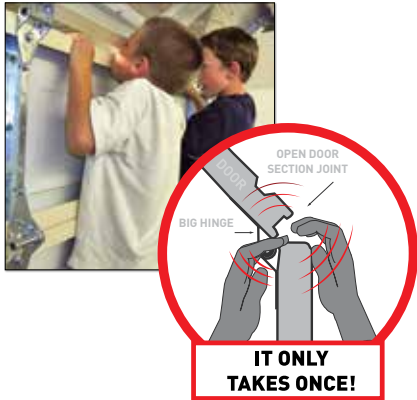

! WARNING
SERIOUS INJURY

Industry Standard Track



! WARNING
SERIOUS INJURY

Industry Standard Spring

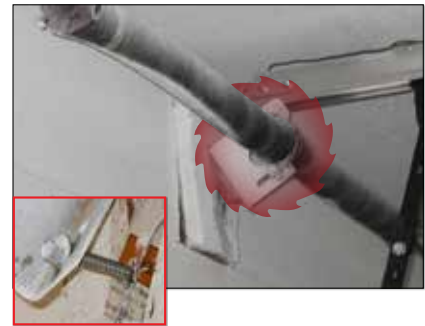

! WARNING
INJURY OR DEATH

Safety Joint System

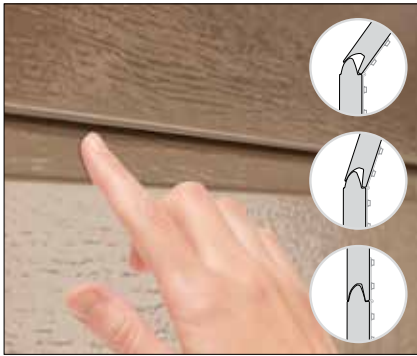

Safety Track System



Safety Spring System

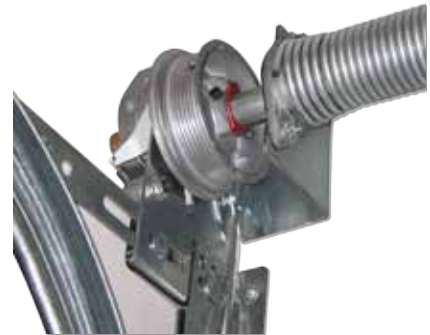

WINNER OF THE INNOVATIONS IN AMERICAN GOVERNMENT AWARD
WELCOMES THE PLEDGE OF

Martin Door Manufacturing

Beauty Meets Safety and Innovation

Martin Door's safety joint is designed to help protect you while adding strength to your door. This joint is available on all Martin doors, improving the design and enhancing beauty.

No other brand offers such a comprehensive system



**GET YOUR
GROOVE ON!**

Martin Door Dealer Info

AD-B16-06



2828 S 900 W, SLC, UT 84119 · 1(800)388.9310

WWW.MARTINDOOR.COM

MADE IN USA SINCE 1936