

RANCH HOUSE® DOORS

 | *Redefining the Entrance™*



Craftsman & Cape Cod Collections™
Custom Built Garage Doors

Craftsman Collection™

Custom Built Garage Doors

www.ranchhousedoors.com

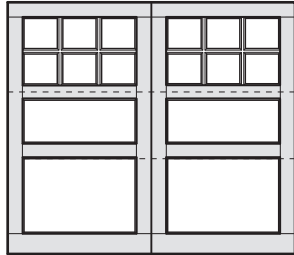

Fowler

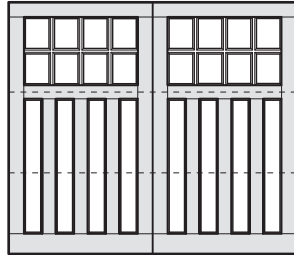

Roberts

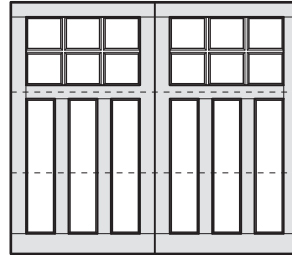

Stickley

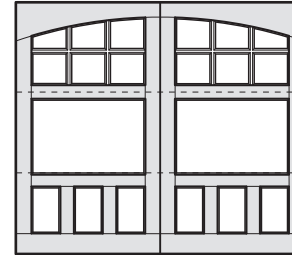

Greene

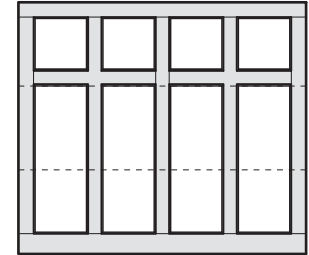

Wilde

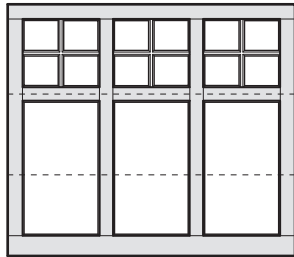

Dietrich

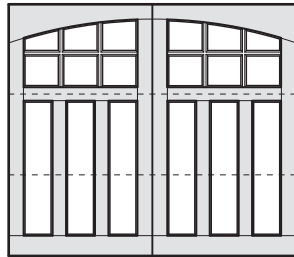

Wilkinson

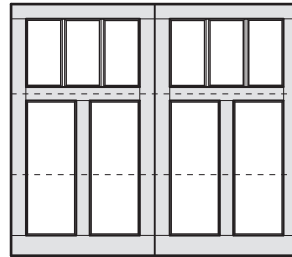

Maybeck

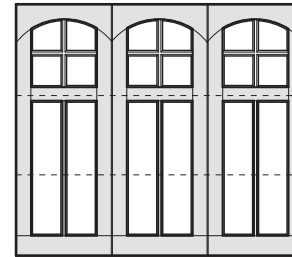

Newcomb

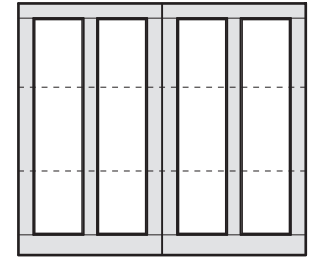

Morris

**doors shown are 8-0 x 7-0 – custom sizes available up 24-0 x 16-0*



RHD853



RHD2300



RHD828



RHD849

 RANCH HOUSE® DOORS



RHD2008



RHD844

www.ranchhousedoors.com

Cape Cod Collection™

Custom Built Garage Doors

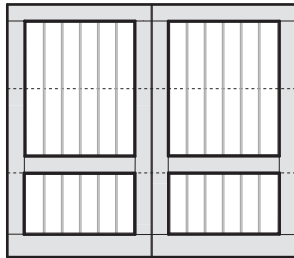

Bayside

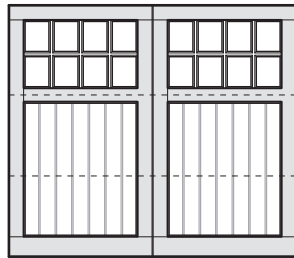

Sconset

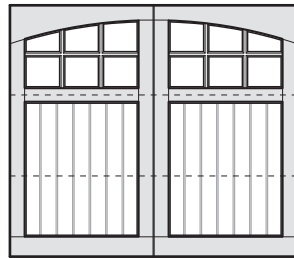

Harborside



Osterville

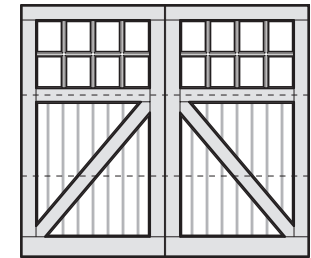

East Chop

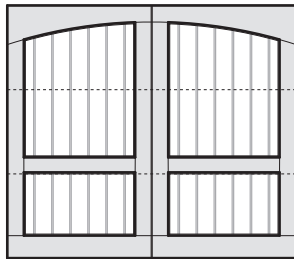

Nantucket



Vineyard

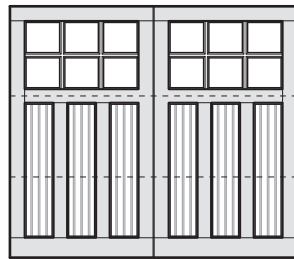

Nauset

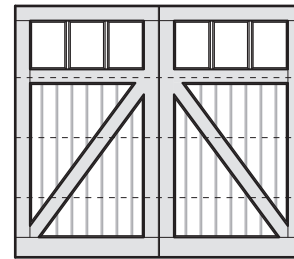

Madaket

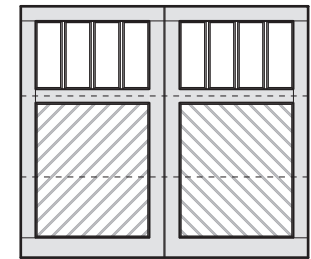

Surfside

**doors shown are 8-0 x 7-0 – custom sizes available up 24-0 x 16-0*



RHD880



RHD264



RHD034

Window Options

NOTE: These tops are drawn for 8-0 x 7-0 doors.
The mullions are 1 3/4" and tru divide lites, unless noted otherwise.

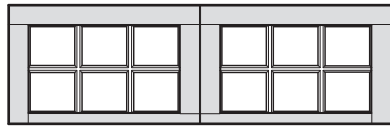

RHD-SQ-1

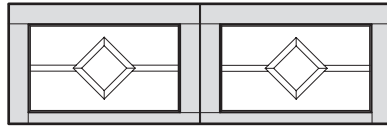

NOTE: These are overlays with 1 1/2" mullions RHD-SQ-9

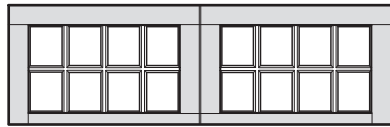

RHD-SQ-2

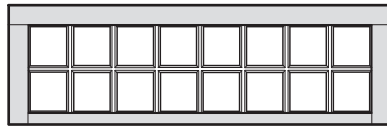

RHD-SQ-10

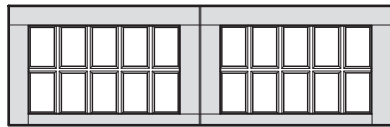

RHD-SQ-3

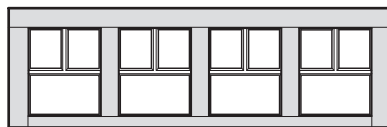

RHD-SQ-11

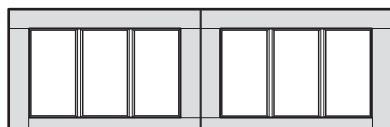

RHD-SQ-4

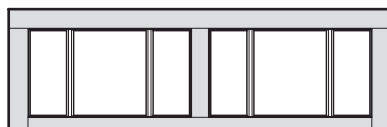

RHD-SQ-12

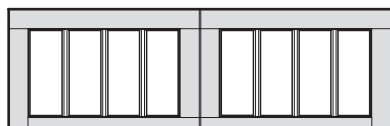

RHD-SQ-5

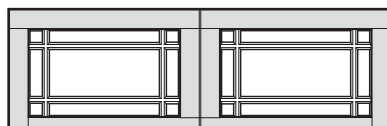

NOTE: Overlays only

RHD-SQ-13

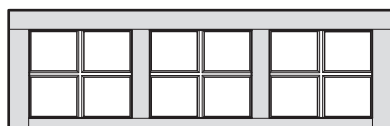

RHD-SQ-6

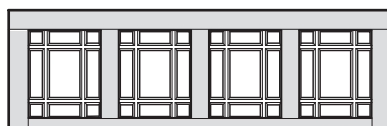

NOTE: Overlays only

RHD-SQ-14

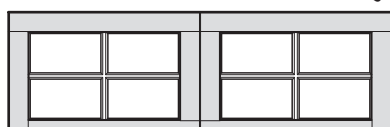

RHD-SQ-7

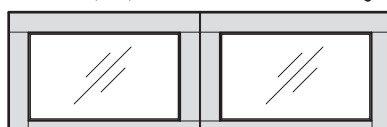

RHD-SQ-15

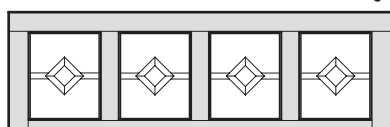

NOTE: These are overlays with 1 1/2" mullions RHD-SQ-8

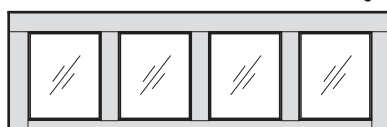

RHD-SQ-16

*Windows are Tru Divided unless otherwise noted
*Window caulking/glazing is available upon request
*Specialty Glass Available upon request

Arch Top & Crossbuck Options



RHD842

Customize your door with an arch top or crossbucks. If you would like to see more of the same options, see our web site at www.ranchhousedoors.com.

Tongue & Groove Options

NOTE: Also available in 1 x 2, 1 x 4 and 1 x 8 upon request



1X6 TONGUE AND GROOVE V GROOVE RHD-TG1



BEADBOARD, 1 5/8" O.C. RHD-TG4

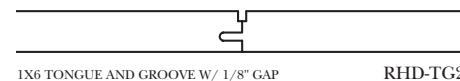

1X6 TONGUE AND GROOVE W/ 1/8" GAP RHD-TG2

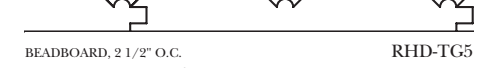

BEADBOARD, 2 1/2" O.C. RHD-TG5

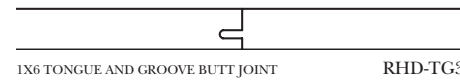

1X6 TONGUE AND GROOVE BUTT JOINT RHD-TG3

Interior Edges Options

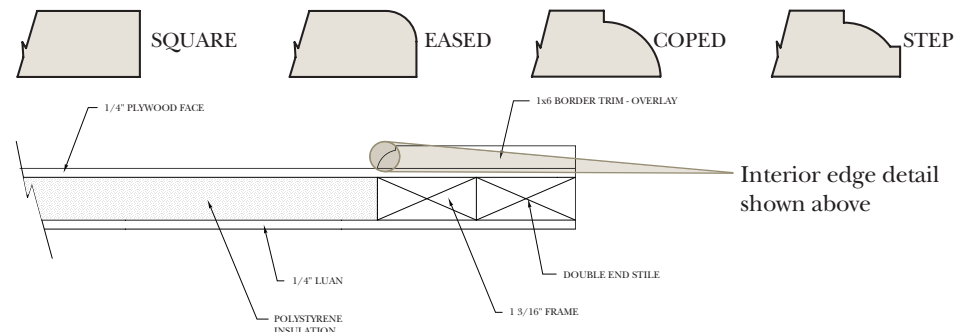

Interior edge detail shown above

Custom Door Specifications

Custom Ranch House Doors are built with a four layer construction method.

- Face and Overlay materials vary – (see our "Most Common Materials" section)
- 1 3/32" hem fir frame FJ
- 1 3/32" polystyrene insulation
- 1/4" luan plywood back

Most Common Materials

Plywoods – used to create a recessed flat panel appearance.

- MDO – 3/8" or 5/8" Medium Density Overlay – a resin based birch veneer core plywood produced with phenolic glue for exterior use – paint grade applications only.
- Luan Plywood
- White Birch Plywood
- Ribbon Mahogany Plywood
- Red Birch Plywood

**Please note that we can custom make plywood out of any material that you would like.*

Composites and Solid Lumber – used for tongue and groove face and overlay applications.

- Extira – a resin based wood composite designed for exterior use – paint grade applications only.
- West Coast Hemlock
- Select Tight Knot Western Red Cedar
- Clear Western Red Cedar
- Vertical Grain Doug Fir
- African Mahogany
- Genuine Mahogany

**Wire Brushing and Distressing available upon request.*

**Please note that we offer over 400 materials to choose from which are available upon request.*

All material shown in this brochure is copyrighted and may not be duplicated in any fashion. © 2008 Ranch House Doors

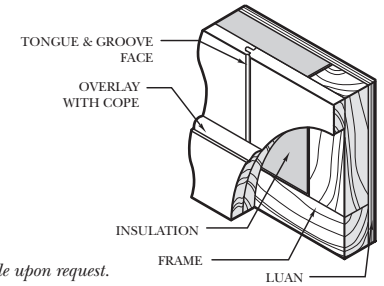
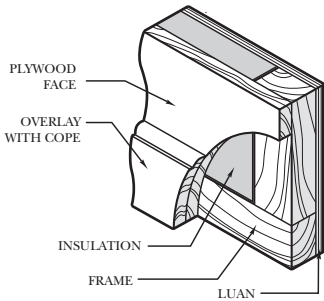

RHD064

In 1990, Mike Neal started building custom garage door parts in his own garage in La Mirada, California. His dream was to make the best custom garage doors in the world — one door at a time. He faithfully put his hand to the plow and forged what is today Ranch House Doors, Inc. North America's leading custom garage door manufacturer.

In 2004, Mike passed away after a long fight with cancer. Although Mike is no longer with us, his vision remains the focal point for his family who continue to run Ranch House Doors, Inc. Every member of RHD is proud of his legacy and look forward to serving you with the same attention and craftsmanship that Mike, our dad and leader, taught us over the years.

— the Neal family



www.ranchhousedoors.com



RHD2301



RHD881



RHD2302



RHD887