



Pulley Therapy

FROM CHINESPORT'S GENERAL CATALOGUE — 2015 EDITION

The **Chinesport** thanks all collaborators who have given their contribution to achieve the present document. In special way the Pulley Therapy program has been developed in collaboration with:

Ares Group
Ricovera & Sciluppe

At our sole discretion, the company reserves the right to change dimensions and type of construction, and to make improvements and other changes to its products. All reproduction right of all or part of the designs and illustrations are reserved throughout the whole world. All dimensions are expressed in centimetres. The printing process does not give a perfect reproduction of the colours.



The equipment illustrated in the present chapter can be subject of specific training and multilevel courses arranged by qualified professionals. So upon request it's possible to arrange events at Chinesport's head office or other site indicated by the customer.

4

Pulley Therapy

FROM CHINESPORT'S GENERAL CATALOGUE – 2015 EDITION

-
- 04 Archimedes Pulley Therapy System - Introduction**

 - 06 Fixed Wall Frames**

 - 07 Fixed Ceiling Frames**

 - 08 2-sided Fixed Frames**

 - 10 Self-supporting frames**

 - 12 Configuration Options**

 - 16 Straps and supports**

 - 18 Handles**

 - 19 Other Tools**

 - 23 Sets of accessories**

 - 24 Ercolina & Poliercolina**

 - 28 Continued Intensive Rehabilitation**

 - 29 Frames**

 - 31 Accessories**

 - 33 The Method**

Archimedes Pulley Therapy System

This is an open pulley therapy system that offers a wide range of exercises of various types, to meet the needs of the professional and the patient. More specifically, it is made up of modular structures that can be adapted to suit operating needs and the space available, a set of harnesses for different areas of the body, and other equipment that complete what is required. The system allows for creativity in designing specific rehabilitation programmes.



The so-called “cage” frame shown above represents the CONFIGURATION EXAMPLE n. 6 described further on in this section.

CE

1) METAL FRAMES

The pulley therapy metal frame system is modular, wide and flexible to meet the professional's requirements depending on available space and type of exercises to develop.

This means that options range from fixed wall or ceiling frames to free-standing frames with two or more support planes. In addition, each work station proposed in its standard configuration can be supplemented by various types of side grids or reinforcement details to increase the safe working load at any time, whether at the moment of purchase or later.

Some icon symbols provide information on maximum or additional standard load for different metal frames. Other basic elements, intended as optionals or accessories, can create more configurations in addition to the proposed standard ones. Some examples are shown in the following pages.

2) HARNESES

Harnesses were designed in various sizes so they can be applied to different body regions to meet specific activity needs. These items meet the requirements of easy sanitation, durability and ease of use when setting up the exercises.

3) ADDITIONAL EQUIPMENT

A number of additional equipment to be used along with or in alternative to harnesses are proposed. This equipment was conceived for various types of exercises and may also be used by professionals to create personalized workout programs to suit the patient's specific needs.

4) COUCHES

UniX series couches are suitable to be used either on their own or in combination with the frames illustrated further on. These couches can be height-adjusted electrically or hydraulically, but there is no segment displacement during adjustment. This means that they can be configured with or without transport castors, and a series of accessories is available. As an alternative, we can also recommend our couches from the Sinthesi range, which are suitable for manipulation and postural exercises. Please read the dedicated section on Chinesport couches.

Due to its vast versatility, Pulley Therapy can be used for adolescents and the aged, for both preventive and therapeutic treatments.

INDICATIONS FOR PREVENTIVE TREATMENT:

- It makes it possible to make movements and assume postures, which keep the correct body balance in the person.
- It prevents damage due to asymmetrical activity by workers.
- In adolescents, it facilitates harmonious growth, protecting against disharmony as a result of sport, play or study activities.

INDICATIONS FOR THERAPEUTIC TREATMENT:

- It favours the mobility and stability of joints after trauma, or in a degenerative pathology context.
- It improves muscle performance and movement of the fascias and therefore the lymphatic vascular flow.
- It makes it possible to assume re-balancing postures for the capsular ligament structures.
- It speeds up recovery of coordination and balance.



SEGMENTAL AND OVERALL COORDINATION AND CONTROL FOR THE WHOLE BODY-
“The video shows raising of the right limb, assisted by the weight but controlled by the person, which is able to stabilise all the other parts of the body, allowing correct extension or elasticising of the rear muscles in the raised limb. Meanwhile, the left limb is left resting on the leg support to allow the correct degree of bending of the hip and knee. This is essential for better control over the stability of pelvis during dynamic exercising workouts.” - Dr Nedda Pellegrini

Archimedes System Fixed Wall Frames

AR11001 FRAME 1

This is a smaller frame to be fitted to the wall either horizontally or vertically. It consists of two 70 cm long, coated metal tubular elements and a high-strength steel grid with scratch-resistant plastic coating and dimensions 93.3 x 60.5 x h 7.1 cm. The grid has a diameter of 5 mm and mesh is 5 x 5 cm. Dimensions: 103.5 x 71 x h 7.5 cm; Weight: 9 kg

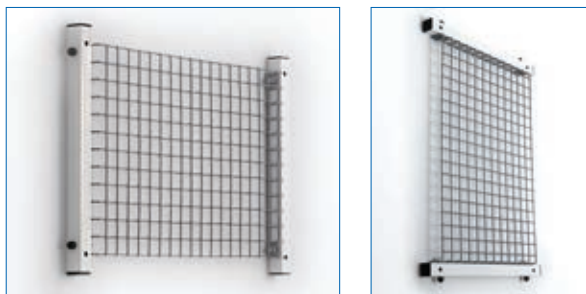
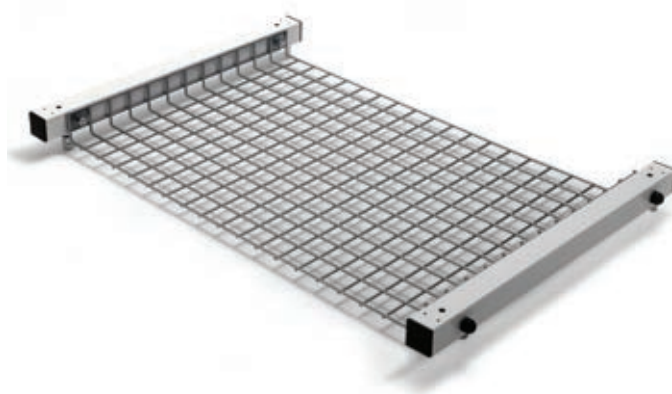

Note: FRAME 1 can be fitted to the wall at the desired height both horizontally and vertically.

AR11002 FRAME 2

This frame can be fitted to the wall either horizontally or vertically. It consists of two 200 cm long, coated metal tubular elements and a high-strength steel grid with scratch-resistant plastic coating with dimensions 93.3 x 60.5 x h 7.1 cm. The grid can be easily fitted in three different positions.

The frame can be upgraded by fitting up to two "standard" grids - ref. code AR11A01 or "quick fit and removal" type grids - ref. code AR11A02. For further details, please see the "Configuration Options" described later on.

Dimensions: 201 x 103.5 x h 7.5 cm; Weight: 19 kg



CONFIGURATION EXAMPLE N. 1

The frame shown here consists of the following elements:

- n. 1 piece AR11002 - FRAME 2
- n. 2 pieces AR11A01 - STANDARD GRID

Note: Upon placing a purchase order for this type of configuration, please specify the codes and quantities as indicated above.

AR11003 FRAME 3



This is a smaller frame for cantilevered fitting to walls. It consists of two coated metal panels at the sides, and a high-strength steel grid with scratch-resistant plastic coating, dimensions 93.3 x 60.5 x h 7.1 cm. The stated capacity is dependent on the wall elements strength.

Dimensions: 103.5 x 75.5 x h 44 cm; Weight: 12 kg

Note: If specifically requested, it is possible to configure a cantilevered frame with more in-line grids.



AR11004 FRAME 4 H



This is a smaller frame to be fitted to the ceiling. It consists of one FRAME 1 - ref. code AR11001 with four adjustable angle brackets, and two reinforcing crossbar elements. Again, the grid is made from high-strength steel with scratch-resistant plastic coating and dimensions are 93.3 x 60.5 x h 7.1 cm. Angle brackets allow for adjusting the grid distance from the ceiling by 4 cm steps. This frame is intended for ceilings that are higher than 274 cm. The stated capacity is dependent on the wall elements strength.

Dimensions: 113 x 84.5 x h 58-102 cm; Weight: 31 kg

AR11011 FRAME 4 L

This frame is similar to code AR11004, but is ideal for ceilings between 250-270 cm high. Dimensions: 113 x 84.5 x h 30-50 cm; Weight: 26 kg

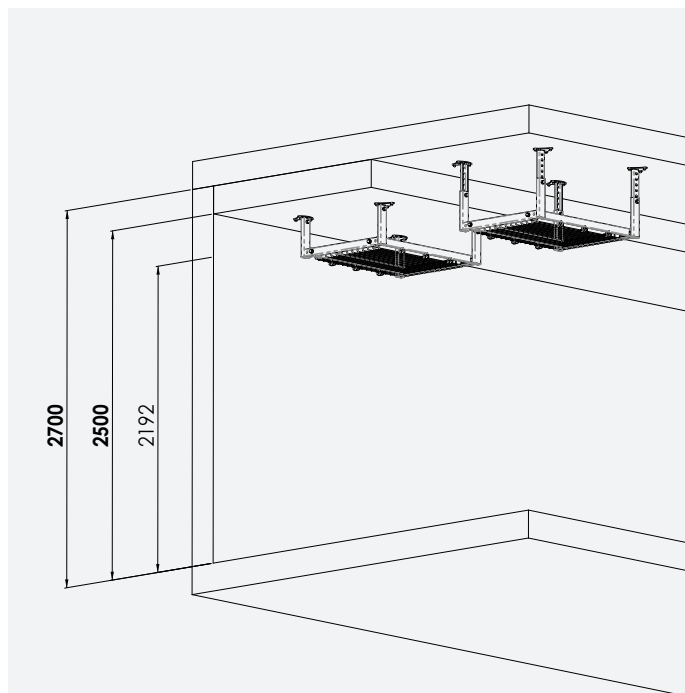
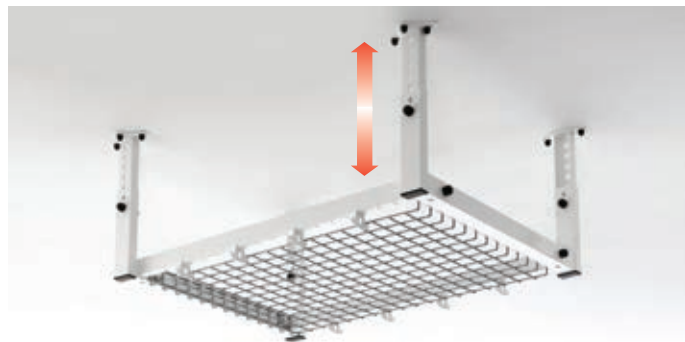

Models:
AR11011 - FRAME 4 L
AR11012 - FRAME 5 L

AR11005 FRAME 5 H



This frame is fitted to the ceiling. It consists of one FRAME 2 - ref. code AR11002 with two additional grids, four adjustable angle brackets, and two reinforcing crossbar elements. All parts are made from coated metal, while grids are high-strength steel with scratch-resistant plastic coating. Angle brackets allow for adjusting the grid distance from the ceiling by 4 cm steps. This frame is intended for ceilings that are higher than 274 cm. The stated capacity is dependent on the wall elements strength and how load is distributed across the three grids.

Dimensions: 113 x 214.5 x h 58-102 cm; Weight: 51 kg

AR11012 FRAME 5 L

This frame is similar to code AR11005, but is ideal for ceilings between 250-270 cm high. Dimensions: 113 x 214.5 x h 30-50 cm; Weight: 46 kg

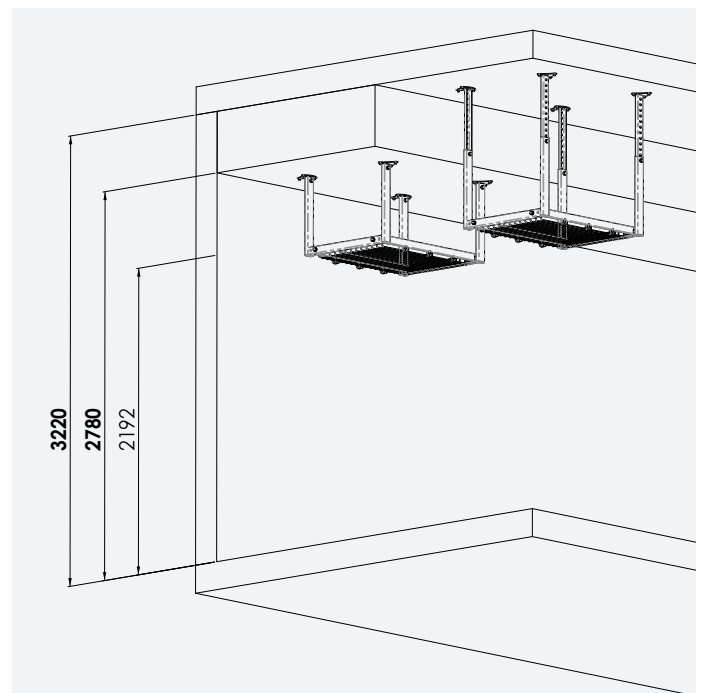

Models:
AR11004 - FRAME 4 H
AR11005 - FRAME 5 H

Archimedes System 2-sided Fixed Frames

AR11006 FRAME 6



This is an exercise frame on two work planes, to be fitted to the wall. It consists of four 200 cm long, coated metal tubular elements, three high-strength steel grids at the top and other connecting and attaching elements, always made from coated metal. Also, grids have a scratch-resistant plastic coating; dimensions are 93.3 x 60.5 x h 7.1 cm. The overall work area on the top level is about 190 x 93.3 cm.

The frame can be upgraded on its vertical side by fitting up to 3 STANDARD GRIDS - ref. code AR11A01 or QUICK FIT GRIDS - ref. code AR11A02. Capacity can be increased up to 200 kg by fitting n. 1 GRID REINFORCEMENT SET - ref. code AR11A04. The stated capacity is dependent on the wall elements strength and on how load is spread across the upper grids. For further details, please see the "Configuration Options" described later on.

Dimensions: 237 x 103.5 x h 227.5 cm; Weight: 57 kg



AR11007 FRAME 7



This is an exercise frame on two work planes, to be fitted to the wall. It consists of six 200 cm long, coated metal tubular elements, six high-strength steel grids at the top and other connecting and attaching elements, always made from coated metal. Also, grids have a scratch-resistant plastic coating; dimensions are 93.3 x 60.5 x h 7.1 cm. The overall work area on the top level is about 190 x 206.6 cm.

The frame can be upgraded on its vertical side by fitting up to 6 STANDARD GRIDS - ref. code AR11A01 or QUICK FIT GRIDS - ref. code AR11A02. Capacity can be increased up to 300 kg by fitting n. 2 GRID REINFORCEMENT SETS - ref. code AR11A04. The stated capacity is dependent on the wall elements strength and on how load is spread through the upper grids. For further details, please see the "Configuration Options" described later on.

Dimensions: 237 x 202 x h 227.5 cm; Weight: 94 kg



CONFIGURATION EXAMPLE N. 2

The L-frame shown here consists of the following elements:

- n. 1 piece AR11006 - FRAME 6
- n. 2 pieces AR11A01 - STANDARD GRID

This type of frame is recommended whenever there is limited operational space that needs to be optimized. Upon placing a purchase order for this type of configuration, please specify the codes and quantities as indicated above.



4

CONFIGURATION EXAMPLE N. 3

The solution proposed here is created from the following main frames plus additional standard grids, starting from the basic setting:

- n. 1 piece AR11006 - FRAME 6
- n. 2 pieces AR11002 - FRAME 2
- n. 7 pieces AR11A01 - STANDARD GRID

This type of frame is also recommended when trying to optimize the available space, as in the configuration example n. 2.

In particular, a very similar structure to the so-called "cage" frame was achieved, i.e. with four closed sides by using two angular walls. Upon placing a purchase order for this type of configuration, please specify the codes and quantities as indicated above.



PULLEY THERAPY

Archimedes System Self-supporting frames

AR11008 FRAME 8



This is a free-standing and self-supporting exercise frame on three work planes. It consists of six 200 cm long painted metal tubular elements, three high-strength steel grids at the top and other connecting and attaching elements, always made from painted metal. Also, grids have a scratch-resistant plastic coating; dimensions are 93.3 x 60.5 x h 7.1 cm. The overall work area on the top level is about 190 x 93.3 cm.

The frame can be upgraded on its vertical side by fitting up to 6 STANDARD GRIDS - ref. code AR11A01 or QUICK FIT GRIDS - ref. code AR11A02. Capacity can be increased up to 200 kg by fitting n. 1 GRID REINFORCEMENT SET - ref. code AR11A04. The stated load is dependent on how load is spread across the upper grids. For further details, please see the "Configuration Options" described later on.

Dimensions: 237 x 103.5 x h 227.5 cm; Weight: 77 kg



AR11009 FRAME 9



This is a free-standing and self-supporting exercise frame on three work planes. It consists of nine 200 cm long painted metal tubular elements, six high-strength steel grids at the top and other connecting and attaching elements, always made from painted metal. Also, grids have a scratch-resistant plastic coating; dimensions are 93.3 x 60.5 x h 7.1 cm. The overall work area on the top level is about 190 x 206.6 cm.

The frame can be upgraded on its vertical side by fitting up to 12 STANDARD GRIDS - ref. code AR11A01 or QUICK FIT GRIDS - ref. code AR11A02. Capacity can be increased up to 300 kg by fitting n. 2 GRID REINFORCEMENT SETS - ref. code AR11A04.

The stated load is dependent on how load is spread across the upper grids. For further details, please see the "Configuration Options" described later on.

Dimensions: 237 x 202 x h 227.5 cm; Weight: 125 kg



SELF-SUPPORTING FRAME WITH COUCH

AC0097.W ? FIXED-HEIGHT COUCH

Option to order an additional frame with a two-section couch to be attached to a self-supporting frame type AR11008, AR11009, AR11010. The couch is fitted at a height of 78 cm, the two sections have a standard length of 68 cm, and the head section can be adjusted upwards to up to 45°.

This module can also be bought at a later stage and includes any necessary hardware. The upholstery colour of the couch has to be chosen among options as presented below. When ordering, please remember to always add the identification code for the upholstery color along with the module code. Working safety load of 200 kg.

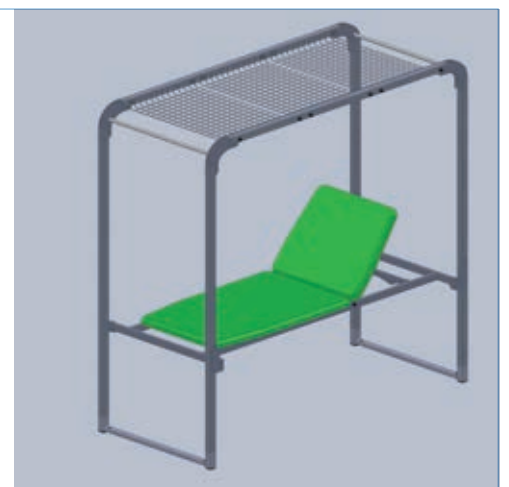

? CHOICE OF UPHOLSTERY COLOR - Important: always specify the upholstery code along with the chosen item when this option is available.



AR11010 FRAME 10



This is a free-standing and self-supporting exercise frame on four work planes. It consists of twelve 200 cm long, coated metal tubular elements, six high-strength steel grids at the top and other connecting and attaching elements, always made from coated metal. Also, grids have a scratch-resistant plastic coating; dimensions are 93.3 x 60.5 x h 7.1 cm. The overall work area on the top level is about 190 x 206.6 cm.

The frame can be upgraded on its vertical sides by fitting up to 18 STANDARD GRIDS - ref. code AR11A01 or QUICK FIT GRIDS - ref. code AR11A02. Capacity can be increased up to 300 kg by fitting n. 2 GRID REINFORCEMENT SETS - ref. code AR11A04. The stated capacity is dependent on how load is spread across the upper grids. For further details, please see the "Configuration Options" described later on.

Dimensions: 237 x 209.5 x h 227.5 cm; Weight: 158 kg



4

CONFIGURATION EXAMPLE N. 4

The frame shown here is the most complex and is universally recognized as "CAGE FRAME", as it consists of three sides and a top level.

In such case, the configuration also provides for two reinforcement element sets to increase the safe working load up to 300 kg. It consists of the following main and additional frame elements:

- n. 1 piece AR11010 - FRAME 10
- n. 18 pieces AR11A01 - STANDARD GRID
- n. 2 pieces AR11A04 - REINFORCEMENT GRID SET

In this case, the frame is configured with a standard number of grids closing off the three vertical sides, but it is equally possible to opt for partial closing by simply reducing the number of additional grids on order. Please remember that quick fit/removal grids can also be used in alternative. As another possible alternative for a frame with four closed work planes; please see the configuration example n. 6 on the following page.

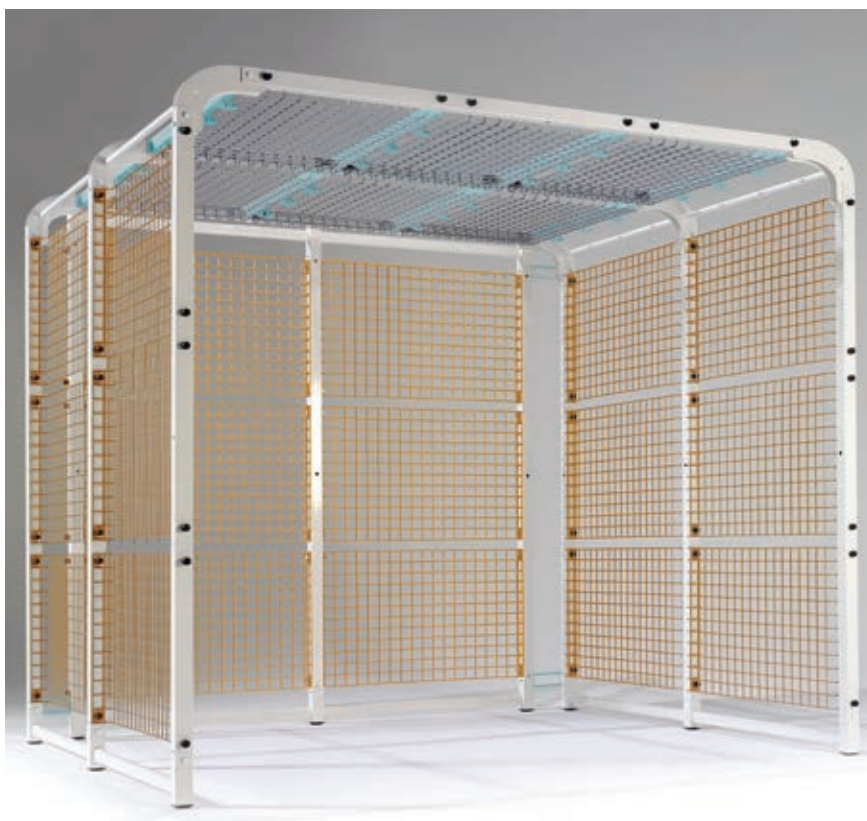

PULLEY THERAPY

Archimedes System Configuration Options

AR11A01 STANDARD GRID

The grid is made from high-strength steel 5 mm diameter bar mesh with scratch-resistant plastic coating and 5 x 5 cm mesh. It can be easily fitted to any frame configured with the specific hardware supplied as standard. Wall or ceiling frames or frames with two or more work planes, either attached to the wall or self-supporting, already use this type of grid as a standard configuration for upper horizontal planes and only for this type of grids, thus ensuring the stated safe working loads. More grids can be ordered to upgrade the frame onto vertical work planes. For an indication on the number of grids that may be added to each type of frame, please refer to the specific presentation in this section of the catalogue. Dimensions: 93.3 x 60.5 x h 7.1 cm; Weight: 5 kg

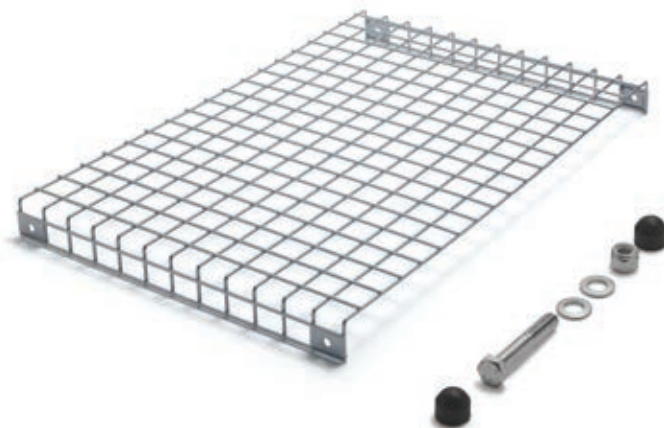

Pulley Therapy exercise in a supine position on a postural table M.I.T.O. with associated exercise ball. This requires the user's full participation.



AR11A02 QUICK FIT GRID

This grid has the same characteristics as item code AR11A01, except for the system attaching the grid to the frame, which does not require any tools for fastening. The standard supply includes four special stainless steel bolts for quick fit and/or removal. It can only be attached to the vertical sides of the chosen frame, as an alternative or in combination with other standard grids. Dimensions: 93.3 x 60.5 x h 7.1 cm; Weight: 5 kg



QUICK FIT GRID AR11A02 - The video shows how you can easily change the grid position along the frame's vertical sides of our ARCHIMEDE Pulley Therapy frames using the special pins included.



AR11A04 GRID REINFORCEMENT SET

It is an assembly of four elements that are attached to the frame on the top horizontal plane so exercises - or more general activities - can be performed with greater safe working loads than those stated as standard.

If needs be, the professional may request one or two of these reinforcement sets - depending on whether the frame is single or double - either at the time of ordering or at a later time. The group of elements is supplied along with specific hardware so they are secured to the main frame. Please refer to the presentation on the frame configurations in this section of the catalogue.

Dimensions: 98.3 x 7 x h 9 cm; Weight: 2.4 kg

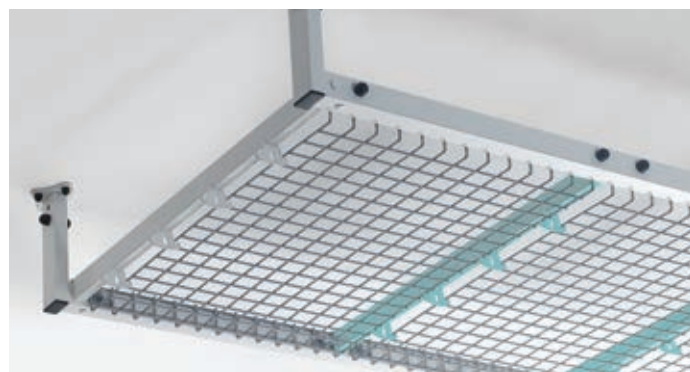

Example of exercises using rep cords to strengthen the abductor muscles. The circuit is created with a STANDARD PULLEY - code 07950 plus an ANKLE SUPPORT 2 - code AC0576.

About Pulley Therapy

TYPE OF APPLICATIONS:

- Suspension of a segment;
- Suspension of a number of segments;
- Gravity-assisted movements;
- Movements against resistance;
- Isometric contractions;
- Isotonic contractions;
- Eccentric contractions;

POSSIBLE OBJECTIVES:

- Elongation and strengthening, to attain myotensive balancing of the muscle groups;
- Restoration of the normal joint range;
- Execution of coordinated movements to improve the neuromotor system;



SUSPENSION OF A SEGMENT - "When lying on the side, the therapist checks the correctness of the position, which must be with the chest perpendicular to the plane, and therefore without rotary compensation. Connecting a rep cord to the ankle makes various exercises possible. The figure shows an oscillating movement on a plane parallel to the couch". - Extract from the Basic Course by Dr. Nedda Pellegrini

Archimedes System Configuration Options

AR11A06 LONG BAR 200

This 200 cm long metal tubular element is universal, i.e. it is used as a base element for many of the frame configurations described here, whether fixed or self-supporting. It can also be ordered separately to upgrade or create other frames as in configuration example n. 5.

In particular, two of these structural elements are required to attach a grid. The element is designed for use with up to a maximum of three grids. Alternatively, the same fixed or quick fit type grid can be easily re-positioned into three different predetermined positions, depending on the exercise to be performed or the user's specific requirements.

Dimensions: 201 x 5 x 5 cm; Weight: 7 kg



AR11A18 CONNECTING SET 2

It consists of two connecting elements at a 90° angle that must be used with a FRAME 2 – ref. code AR11002, and additional standard or quick fit-type grids if required – ref. codes AR11A01 or AR11A02 (up to a maximum of three grids). This setting allows for creating an additional vertical work plane for FRAME 8 or FRAME 9, **while providing additional stability to the main frame** to which it is attached.

The additional exercise area at the side can therefore range from a minimum of 93.3 x 60.5 cm (with one grid) to a maximum of 190 x 93.3 cm (with three grids). Finally, it is worth pointing out that, if attached to FRAME 9 together with the elements detailed above, the “connecting set” also provides an alternative to the so-called “cage frame” previously identified as FRAME 10. (Please see configuration example n. 6)

Dimensions: 124 x 22.3 x 47 cm; Weight: 2.3 kg



Note: The set can be ordered at the time of purchasing the main frame, or at a later time together with the other components.

AR11A19 CROSSBAR

This lateral crossbar element can be attached to the vertical side of a standard frame with at least two work planes - see FRAME 6 - 7 - 8 - 9 - 10. This configuration provides an alternative to using one grid, which increases the frame strength on the short side and can be used to hang straps and harnesses.

Dimensions: 102.5 x 5 x h 2.5 cm; Weight: 2.2 kg



LEARNING A CORRECT POSTURAL CONTROL - exercises to maintain balance on a footplate code 02600, with small movements of the arms supported by straps - code AC0577, and an rep cords circuit.



CONFIGURATION EXAMPLE N. 5

The configuration shown here uses two available walls, one supporting the L-frame and the other one as a vertical support/work side, by applying another special frame. It therefore consists of the following structural and optional elements:

- n. 1 piece AR11006 - FRAME 6
- n. 1 piece AR11002 - FRAME 2
- n. 1 piece AR11A06 - LONG BAR 200
- n. 8 pieces AR11A01 - STANDARD GRID

This type of frame is also recommended when trying to optimize the available space, as in configuration examples n. 2 and 3 previously described. However, the difference lies in a greater work surface provided by a second series of three grids attached to the back wall by adding one single tubular element identified as 200 CM LONG BAR.

Note: Upon placing a purchase order for this type of configuration, please specify the codes and quantities as indicated above.



CONFIGURATION EXAMPLE N. 6

The frame shown here is a variation of the so-called "CAGE FRAME" previously identified as configuration n. 4, which is made up of three sides and an upper plane. In particular, the key difference is that one side is closed off by means of a CONNECTING SET 2 – ref. code AR11A18 and that a FRAME 2 – ref. code AR11002 is used. In addition, in the configuration shown here the standard grids are not used to fully close the vertical sides. Finally, the safe working load is increased up to 300 kg by fitting the two reinforcement element sets. Therefore, the frame consists of the following structural and optional elements:

- n. 1 piece AR11009 - FRAME 9
- n. 1 piece AR11002 - FRAME 2
- n. 1 piece AR11A18 - CONNECTING SET 2
- n. 11 pieces AR11A01 - STANDARD GRID
- n. 2 pieces AR11A04 - REINFORCEMENT GRID SET

Please remember that quick fit/removal grids can also be used in alternative.



MAXIMUM EXERCISE LOAD UP TO 

Archimedes System Straps and supports



COORDINATION - HEAD MOVEMENTS: "The therapist guides the sideways bending movement of the head. With one hand they block the SIAS to immobilise the pelvis. The legs are suspended to relieve the lombo-sacral section of any load. Mobilisation of the cervical spine also involves the dorsal section." "Hooking the PT circuit to the ankles does not only relieve load from the lower limbs and the spine, but it serves to make coordinated movements that alternate with mobilisation of the cervical spine in a completely load-free state. This hook can be replaced by a leg support on a cube, on a ball, elongated on the couch plane, etc., depending on the goal to be achieved". - Extract from the Basic Course by Dr. Nedda Pellegrini



AC0055 SMALL STRAP

Padded strap with black synthetic leather lining and 35 mm diameter chromed rings at the ends. Comfortable and easy to disinfect, it provides support to lower/upper limbs. (single item)
Dimensions: 44 x 12 x 1.5 cm; Weight: 120 g.



AC0056 MEDIUM STRAP

Padded strap with black synthetic leather lining and 35 mm diameter chromed rings at the ends. Comfortable and easy to disinfect, it provides support to lower/upper limbs or to keep the head suspended. (single item).
Dimensions: 69 x 12 x 1.5 cm; Weight: 170 g.



AC0295 LARGE STRAP

Padded strap with black synthetic leather lining and 35 mm diameter chromed rings. Comfortable and easy to disinfect, it is recommended as a support and lift for trunk/pelvis. (single item)
Dimensions: 92 x 12 x 1.5 cm; Weight: 200 g.



AC0296 EXTRA LARGE STRAP

Padded strap with black synthetic leather lining and 35 mm diameter chromed rings. Comfortable and easy to disinfect, it is recommended as a support and lift for trunk/pelvis. (single item)
Dimensions: 110 x 24 x 1.5 cm; Weight: 330 g.



AC0297 CERVICAL STRAP

Strap recommended as a support and lift for the head and for traction exercises. Chromed rings at the ends have a diameter of 35 mm. (single item)
Dimensions: Length 74 x 10 x 1.5 cm; Weight: 140 g.



AC0300 FOOT STRAPS

Padded foot straps with semi-rigid sole and three support areas - lower, back and top/front, they comfortably adapt to any foot shape. Chromed rings have a diameter of 20 mm. There are three Velcro fastenings/adjustments. (for the pair)
Dimensions: 55 x 35 x 1.5 cm; Weight: 900 g.



AC0059 ANKLE SUPPORT 1

Padded strap with black synthetic leather lining and a chromed ring; it is fastened with high resistant Velcro adjustable strap. Comfortable and easy to disinfect. (single item) Dimensions: 26 x 9 x 1.5 cm (closed)



AC0060 WRIST SUPPORT

Padded strap with black synthetic leather lining and a chromed ring; it is fastened with high resistant Velcro adjustable strap. Comfortable and easy to disinfect. (single item). Dimensions: 23 x 7 x 1.5 cm (closed)



AC0577 PERFORATED STRAP

Padded strap with black synthetic leather lining and 4 rings, comfortable and easy to disinfect. It can also be used as an ankle support or to keep limbs suspended. (single item). Dimensions: 50 x 23 x 1.5 cm



AC0576 ANKLE SUPPORT 2

Padded strap with black synthetic leather lining and 2 chromed rings, it is fastened with Velcro strap. (single item). Dimensions: 31 x 29 x 2 cm (closed)



AC0303 SMALL CYLINDRICAL SUPPORT

Semi-rigid support with anti-bacterial and anti-mite synthetic leather lining, removable and easy to disinfect. It is supplied with an inner strap provided with two 20 mm diameter chromed attachment rings. Recommended to support the knee when suspended or provide support to the cervical area. (single item) Dimensions: ø 10 cm x length 36 cm; Weight: 700 g.



AC0304 LARGE CYLINDRICAL SUPPORT

Semi-rigid support with anti-bacterial and anti-mite synthetic leather lining, removable and easy to disinfect. The ends have two rings cast together with the manual attachment rope support. Recommended in dorsal spine mobilization exercises. (single item) Dimensions: ø 15 cm x length 64 cm; Weight: 1.2 kg



COORDINATION – COMBINED MOVEMENTS

“The entire spinal column can be mobilised by suspending the head and trunk using a strap, and positioning the hands with the fingers interlocked to guide the movement of the head.”

- Extract from the Basic Course by Dr. Nedda Pellegrin

Note: A SET OF STRAPS - code AC0325, , as shown in the picture, can be ordered. Please see the type and quantities suggested on the following page.

Archimedes System Handles



BALANCE ON AN EXERCISE BALL AND ARM PT

"This exercise implies greater control of the body and forces correct balancing reactions. Note the position of the body on the vertical. The stretch on the left side is achieved by elongating the same arm and leg"

Extract from the Basic Course by Dr Nedda Pellegrini



07930 HANDLE 1

Plastic handle with a chromed metal open ring for quick attachment. It can be used during suspension or strengthening exercises. (single item)

Dimensions: 18 x 14 x 4 cm; Weight: 170 g.



AC0298 HANDLE 2

30 mm diameter handle with non-slip rubber grip, with 35 mm diameter chromed attachment ring. It can be used during suspension or strengthening exercises.

(single item). Dimensions: 22 x 16 x Ø 3 cm; Weight: 100 g.



AC0299 HAND-WRIST-ANKLE STRAP

Strap indicated for use during suspension or strengthening exercises or as ankle support.

Completed by a 35 mm diameter chromed attachment ring. (single item). Dimensions: 33 x 5 x 1.5 cm; Weight: 50 g.



07970 HANDLE 3

Plastic handle with chromed metal construction and five 30mm diameter attachment rings. It can be used as support handle with the option to change user stability by increasing or reducing the attachment points. (single item). Dimensions: 21 x 19 x Ø 3 cm;

Weight: 370 g.



BALANCING ON AN EXERCISE BALL AND PULLEY THERAPY FOR ARMS - "Exercises in a seated position on a ball, which is an unstable surface, are aimed to stimulate balance reactions and create a control of the body that is segment by segment as well as global. Also, these exercises enhance perceptual qualities and coordination, as they can be performed moving two sections of the body simultaneously. - Extract from the Basic Course by Dr Nedda Pellegrini.

Note: A SET OF HANDLES - code AC0326, , as shown in the picture, can be ordered. Please see the content by type and quantities suggested on the following page.



07950 STANDARD PULLEY

Basic element to be used in combination with snap hook code AC0094 to configure the exercises. The pulley can be rotated so it can be used in any direction. (single item)
Dimensions: 10 x 5 x 2.5 cm;
Weight: 84 g.



AC0294 PLUS PULLEY

Basic element with snap hook included and possibility of rotation. This device also helps the therapist save time when performing practical configuration activities for an exercise, as the rope can be pulled off while in use without removing the equipment that is attached to it. (single item)
Dimensions: 15.5 x 6 x 4 cm;
Weight: 105 g.



AC0293 ROPE STOPPER

This item is useful to adjust the rope length, once equipped with the required accessories, depending on the exercise to perform; adjustments are made by the therapist easily and quickly without having to tie up the rope in different positions manually. (single item)
Dimensions: 9 x 4 x 2 cm; Weight: 45 g.



AC0301 SPACER

This is a metal element with plastic coating that can be fitted to a grid in vertical position. It allows for the pulley to be separated from the grid while it is sliding, and this prevents contact and rubbing between rope and frame during use. (single item)
Dimensions: 11 x 7 x h 6.5 cm
Weight: 300 g.



BALANCE ON A EXERCISE BALL AND ARM PT
"On the ball, the movement of opening the arms is associated with rocking forwards with the torso."
Extract from the Basic Course by Dr Nedda Pellegrini

Note: A SET OF TOOLS - code AC0327, as shown in the picture, can be ordered. Please see the type and quantities suggested on the following page.

Archimedes System *Other accessories*



STARTING POSITION PATIENT SEATED WITH STRAPS
"The patient is asked to control the state of relaxation of their shoulders. In this position they can make movements to free up the joint with a controlled excursion, and learn to keep the spine upright."
 Extract from the Basic Course by Dr Nedda Pellegrini



REP CORDS

A medium resistance elastic tubing available in two different lengths (recommended). Lattice free and odorless. A tube with different degrees of resistance - five planes - is also available. Please see the appropriate section of the catalogue for this. Supplied as a package.



- 31220** 7.6 M REP CORD
- 31300** 30.5 M REP CORD



AC0292 PLASTIC CLAMPS FOR REP CORD

This device allows for a rep cord to be properly secured to the snap hooks or directly to the equipment attachment ring, saving the therapist's time when setting up the exercise. (two items)
 Dimensions: 3 x 3.5 x 2 cm; Weight: 20 g.



COORDINATION - DOUBLE SUSPENSION:

"Short oscillating movements can be made by alternating the head and the legs. This has the effect of freeing up and mobilising the entire spine."
 Extract from the Basic Course by Dr Nedda Pellegrini





07920 S-SHAPED HOOK

Basic multi-purpose element, can be used to configure exercises with pieces of equipment that do not require a closed attachment ring; it can also be used to be hooked directly to the grid. (single item).

Dimensions: 5 x 2.5 x 0.5 cm; Weight: 15 g.



AC0094 SNAP HOOK

Basic multi-purpose element, used to safely link the grid / frame and the various pieces of equipment (accidental detachment is impossible). It is used, for example, along with the STANDARD PULLEY - ref. code 07950 for hooking the latter directly to the grid, or using a strap.

Dimensions: 7 x 3.5 x 0.7 0 cm
Weight: 25 g.



BAGS

Bags have synthetic leather lining and a 35 mm diameter attachment ring. They are available in six different weights. They are supplied as single items.

08035 – BAG 0.5 KG

08045 – BAG 1 KG

08055 – BAG 2 KG

08065 – BAG 3 KG

08075 – BAG 4 KG

08085 – BAG 5 KG



THERAPY PULLEY CIRCUITS

A set of 30 metres of special rope can be ordered as a standard item in order to set up various work circuits, or the number of metres you prefer. The relevant codes are as indicated below. Circuits can also be formed with th elastics.

07980 ROPE PER METRE

Nylon rope. Sold by the metre.

07981 30 M SET

Basic element - 30 m long nylon rope.



Note: A SET OF WEIGHT BAGS - code AC0077, as shown in the picture, can be ordered. Please see the content by type and quantities suggested on the following page.

Archimedes System *Other accessories*



AC0323 SPREADER BAR

Metal construction with three 1.2 cm diameter attachment rings for use with other accessories by means of snap hooks (ref. code AC0094). Please see the examples in the pictures previously shown in this section. Dimensions: 35 x 7 x 0.5 cm; Weight: 135 g.



09420 CHIN STRAP WITH SPREADER BAR

This support restrains the head while performing cervical traction exercises. It is reinforced and has Velcro fastenings. Supplied together with metal spreader bar ref. code AC0323. Dimensions: 35 x 7 x 0.5 cm; Weight: 250 g.

PELVIC HARNESSSES

Padded harnesses in different sizes with gray synthetic leather lining and Velcro fastening strap. They also have a belt with an adjustable metal buckle for attachment to a multi-purpose rope. Recommended for lumbar self-traction exercises. It is supplied as a single item.



AC0321 PELVIC HARNESS - SMALL

Dimensions: 112 x 32 x 1.5 cm
Weight: 460 g.

AC0320 PELVIC HARNESS - LARGE

Dimensions: 136 x 33 x 1.5 cm
Weight: 560 g.



AC0302 EXERCISE BAR

Coated tubular metal bar with 3 rings for attachment to a rope and other accessories through a snap hook (ref. code AC0094), depending on the exercise set up by the therapist. The attachment rings can also be moved along the bar in three other positions. (single item); Dimensioni: cm 111 x 11,5 x 4; Peso: Kg 2





Chinesport recommends the following items as a basic equipment for a pulley therapy exercise station - they are divided by type and quantity, according to homogeneous groups:

AC0325 SET OF STRAPS

Set of n. 17 straps as per following list: n. 5 pcs AC0055, n. 2 pcs AC0056, n. 1 pc AC0295, n. 1 pc AC0296, n. 1 pc AC0297, n. 1 pc AC0300, n. 1 pc AC0059, n. 2 pcs AC0060, n. 2 pcs AC0577, n. 1 pc AC0576.

AC0326 SET OF HANDLES

Set of n. 6 different type handles for exercises and various applications. In particular, the set consists of n. 2 pcs AC0298, n. 2 pcs AC0299, n. 1 pc 07970 and n. 1 pc 07930.

AC0327 SET OF ACCESSORIES

Set of n. 9 types of items in the following quantities: n. 8 pc 07950, n. 1 pc AC0294, n. 4 pcs AC0293, n. 1 pc AC0301, n. 1 pc 07980, n. 1 pc 31220, n. 2 pcs AC0292, n. 10 pcs 07920, n. 10 pcs AC0094.

AC0077 SET OF BAG WEIGHTS

Set of n. 6 different weight bags with 35 mm diameter chromed attachment ring. Weights are 0.5-1-2-3-4-5 kg.

AC0328 FULL SET

It consists of 1 piece for each group of available items, i.e. straps, handles, weights and other accessories required to set up the exercises.



07955 PULICAR TROLLEY

Coated steel trolley with two shelves with raised edges. It has a handle and swiveling castors for transport. Bags can be hung on the three pegs fitted to a bracket. Dimensions 65 x 45 x 95 h cm



Pulley Therapy - Ercolina



07405 ERCOLINA SINGLE

Equipment designed to perform counter-resistance strengthening exercises for upper and lower limbs. Exercises can be performed in all directions, either standing or seated, and with limited variable loads applied by means of weights. It also gives you the option of adjusting and locking the pulley in any intermediate position along the whole frame length up to 220 cm.

An exercise manual is included, with suggested uses in various modes: in an upright position or seated, or with various accessories.

Adjustment is very easy and doesn't require any tools, as there is simply a sliding action along a chromed bar. The frame is made from coated steel and intended for use as a wall-mounted application. It is supplied with a set of 10 weights of 1 kg each and one weight of 0.5 kg.

Fasteners are included. Dimensions: 20 x 33 x h 220 cm
Weight: 12 kg

Note: Lower limbs exercises can also be performed by adding accessories AC0094 - SNAP HOOK and AC0059 ANKLE SUPPORT 1.



CE



An exercise manual is included, with suggested uses in various modes: in an upright position or seated, or with various accessories. (please see the exercise example shown on the next page).



AC0302 EXERCISE BAR

Coated tubular metal bar with 3 rings for attachment to a rope and other tools through a snap hook (ref. code AC0094), depending on the exercise set up by the therapist. The attachment rings can also be moved along the bar in three other positions. Recommended for lumbar self-traction exercises. (single item); Dimensions: 111 x 11.5 x 4 cm; Weight: 2 kg

ACCESSORIES

For upper limbs exercises

- AC0094 SNAP HOOK**
- AC0298 HANDLE 2**
- AC0299 HAND-WRIST-ANKLE STRAP**
- AC0060 WRIST SUPPORT**
- AC0302 EXERCISE BAR**

For lower limbs exercises

- AC0094 SNAP HOOK**
- AC0059 ANKLE SUPPORT 1**

For exercises in a seated position

- 04820 BENCH**
- 04840 GINNY BENCH**
- 04850 PIVETTA BENCH**



ACCESSORIES



04820 BENCH

Coated steel construction, padded board and synthetic leather lining.
Dimensions: 60 x 30 x h 42 cm



04840 GINNY BENCH

Coated steel construction, padded board and synthetic leather lining..Adjustable backrest.
Dimensions: 120 x 30 x h 42 cm



04850 PIVETTA BENCH

Coated steel construction, padded board and synthetic leather lining.
Dimensions: 128 x 28/23 x h 42 cm



AC0094 SNAP HOOK

Basic multi-purpose element, used to safely link the grid / structure and the various pieces of equipment (accidental detachment is impossible). Dimensions: 7 x 3,5 x 0,7 ø 3 cm; Weight: 25 g.



AC0298 HANDLE 2

30 mm diameter handle with non-slip rubber grip, with 35 mm diameter chromed attachment ring. Can only be used with accessory AC0094 – SNAP HOOK. (single item)
Dimensions: 22 x 16 x ø 3 cm
Weight: 100 g.



AC0299 HAND-WRIST-ANKLE STRAP

Strap indicated for use during suspension exercises or as ankle support. Completed by a 35 mm diameter chromed attachment ring. Can only be used with accessory AC0094 – SNAP HOOK. (single item).
Dimensions: 33 x 5 x 1.5 cm; Weight: 50 g.



AC0059 ANKLE SUPPORT 1

Padded strap with a black synthetic leather lining with a chromed ring. Comfortable and easy to disinfect. (single item)
Dimensions: 26 x 9 x 1.5 cm (closed)



AC0060 WRIST SUPPORT

Padded strap with a black synthetic leather lining with a chromed ring; it is fastened with high resistant Velcro adjustable strap. Comfortable and easy to disinfect. (single item)
Dimensions: 23 x 7 x 1.5 (closed)

Exercise 1 FRONTAL ADDUCTION

1 - Starting position:

Upright, in front of the Ercolina. Upper limb in front and raised, in a long position, gripping the handle located in the upper area;

2 - Execution

Pull the handle downwards keeping the limb positioning unaltered.

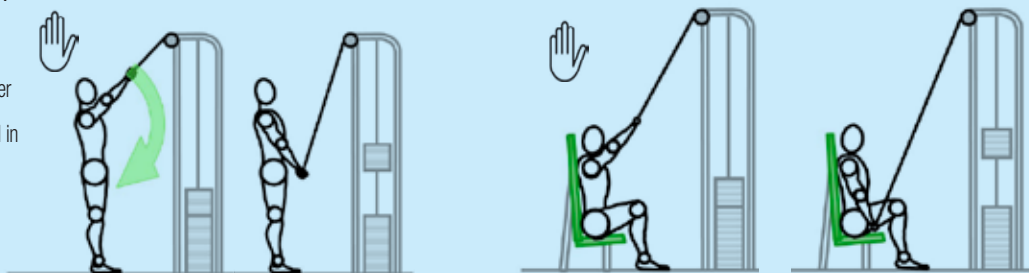

RECOMMENDED METHOD: With a Ginny bench - accessory code 04840

Pulley Therapy - Poliercolina

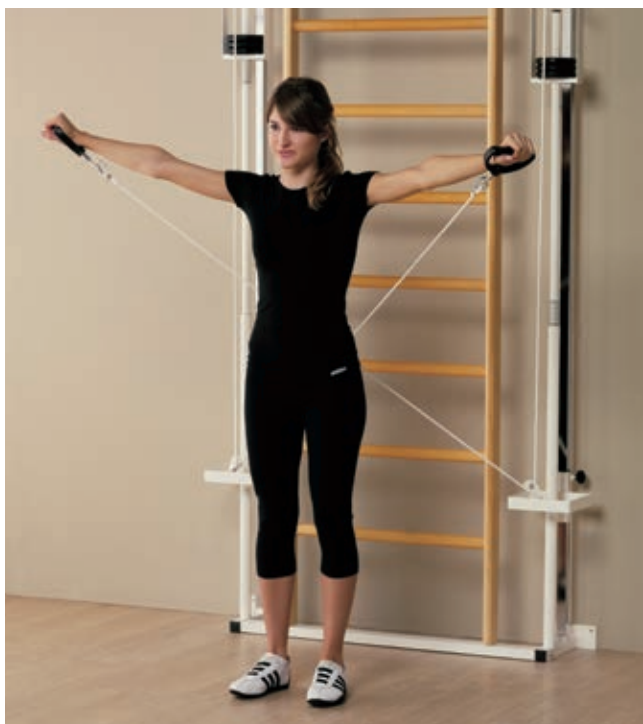

07415 POLIERCOLINA

Equipment designed to perform counter-resistance strengthening exercises for upper and lower limbs. Exercises can be performed in all directions, either standing or seated, and with limited variable loads applied by means of weights. In particular, the user can be requested to exercise both upper limbs while performing specific exercises. It also gives you the option of adjusting and locking the pulleys in any intermediate position along the whole frame length up to 220 cm. An exercise manual is included, with suggested uses in various modes: in an upright position or seated, or with various accessories (see the sample exercise shown on the page next to this one). Adjustment is very easy and doesn't require any tools, as there is simply a sliding action along chromed bars. A wall bar is also supplied, offering further exercise options. The frame is made from coated steel and intended for use as a wall-mounted application. It is supplied with a set of 20 weights of 1 kg each and 2 weights of 0,5 kg. Fasteners are included. Dimensions: 122 x 33 x h 220 cm; Weight: 74 kg



ACCESSORIES

For upper limbs exercises

AC0094 SNAP HOOK

AC0298 HANDLE 2

AC0299 HAND-WRIST-ANKLE STRAP

AC0060 WRIST SUPPORT

AC0302 EXERCISE BAR

For lower limbs exercises

AC0094 SNAP HOK

AC0059 ANKLE SUPPORT 1

For exercises in a seated position

04820 BENCH

04840 GINNY BENCH

04850 PIVETTA BENCH

04720 ABDOMINAL BENCH



AC0302 EXERCISE BAR

Coated tubular metal bar with 3 rings for attachment to a rope and other tools through a snap hook (ref. code AC0094), depending on the exercise set up by the therapist. The attachment rings can also be moved along the bar in three other positions. Recommended for lumbar self-traction exercises. (single item); Dimensions: 111 x 11.5 x 4 cm; Weight: 2 kg



ACCESSORIES



04820 BENCH

Coated steel construction, padded board and synthetic leather lining.

Dimensions: 60 x 30 x h 42 cm



04840 GINNY BENCH

Coated steel construction, padded board and synthetic leather lining.. Adjustable backrest.

Dimensions: 120 x 30 x h 42 cm



04850 PIVETTA BENCH

Coated steel construction, padded board and synthetic leather lining.

Dimensions: 128 x 28/23 x h 42 cm



04720 ABDOMINAL BENCH

Coated steel construction, padded board and synthetic leather lining. Adjustable foot support; a cervical cushion is supplied.

Dimensions: 196 x 32 x h 32 cm



AC0298 HANDLE 2

30 mm diameter handle with non-slip rubber grip, with 35 mm diameter chromed attachment ring. It can only be used with accessory AC0094 – SNAP HOOK. (single item)

Dimensions: 22 x 16 x ø 3 cm

Weight: 100 g.



AC0299 HAND-WRIST-ANKLE STRAP

Strap indicated for use during suspension exercises or as ankle support. Completed by a 35 mm diameter chromed attachment ring. (single item).

Dimensions: 33 x 5 x 1.5 cm

Weight: 50 g



AC0059 ANKLE SUPPORT 1

Padded strap with a black synthetic leather lining with a chromed ring. Comfortable and easy to disinfect (single item).

Dimensions: 26 x 9 x 1.5 cm (closed)



AC0060 WRIST SUPPORT

Padded strap with a black synthetic leather lining with a chromed ring; it is fastened with high resistant Velcro adjustable strap. Comfortable and easy to disinfect. (single item)

Dimensions: 23 x 7 x 1.5 cm (closed)



AC0094 SNAP HOOK

Basic multi-purpose element, used to safely link the grid / structure and the various pieces of equipment (accidental detachment is impossible). Dimensions: 7 x 3.5 x 0,7 ø cm;

Weight: 25 g.



An exercise manual is included, with suggested uses in various modes: in an upright position or seated, or with various accessories. (please see the exercise example shown below).



Exercise 1 FRONTAL ADDUCTION, Method: POLIERCOLINA

1 - Starting position:

Upright, in front of the Ercolina. Upper limb in front and raised, in a long position, gripping the handle located in the upper area.

2 - Execution

Pull the handle downwards keeping the limb positioning unaltered.

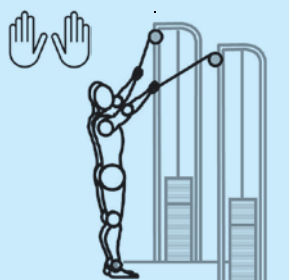

RECOMMENDED METHOD: with accessory code AC0302

R.I.C. Continued Intensive Rehabilitation - Frames

This rehabilitation program makes the most of the natural physiological resources of the human body through intense stimulation and strong motivations. The R.I.C. rehabilitation station has been designed for the motor recovery and functional recuperation in spinal cord injury patients through an innovative motor rehabilitation method that is intensive, continued and personalized.



RIC0100.01 R.I.C. BASIC FRAME

Motor rehabilitation station for a wide range of active exercises in various postures, also with the addition of weights and counterweights, to stimulate muscle recruitment and strengthening, balance, coordination and proprioception. In particular, the exercises can also be performed while lying supine, prone, on the side, or in a seated position, on all fours, or standing upright.

The areas to be treated can also be positioned in axial suspension to help move them and achieve the widest possible joint ROM. Finally, each exercise can be performed with different, personalized ranges of motion.

The frame is versatile, as the range of possible exercises would normally require to use various equipment and consequently to move the patient. The therapist's job is generally made easier. Dimensions 298 x 121 x 225 h cm

Standard configuration includes:

Adjustable bar	2 pcs	110 cm Chain kit	4 pcs
Movable crossbar (for sides)	2 pcs	Bar with R.I.C. hook	1 pc
Swivel pulley	6 pcs	Set of leather items	1 pc
Bobath feet-side fitting	2 pcs	Pulley therapy handle	2 pcs
Bobath head-side fitting	2 pcs	Pillow code 09600	2 pcs
Upper longitudinal member	1 pc	Pillow code 09620	1 pc
Frame	2 pcs	Pillow code 11250	1 pc
Movable upper crossbar	1 pc	Quick release pins (additional)	2 pcs
Loading cells unit	1 pc	Quick release pins for chains (add.)	2 pcs
Articulated footplate (for the pair)	12 pcs	S-shaped hook	8 pcs
R.I.C. quick coupling handle	2 pcs	Snap hooks	10 pcs
30 cm Chain kit	2 pcs	"Alboland" transfer straps	2 pcs

Suitable for R.I.C. Rehabilitation

Metodica R.I.C.
Riabilitazione Intensa Continua

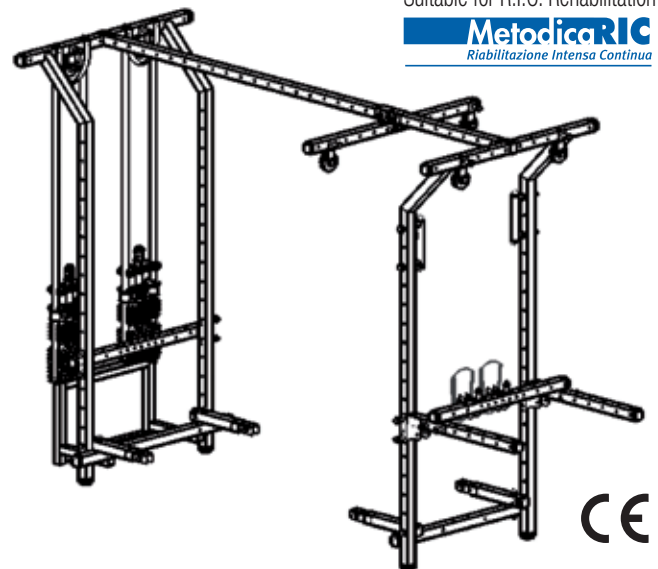

TO ORDER:

the basic frame must be ordered along with a special treatment table type Bobath and can be used in combination with a standing frame for exercises in the upright position (code AC 0100.01). The station is provided with a series of basic elements and can be expanded with accessories.

LB432A2.W ? BOBATH S RIC120

Treatment table, with electrically adjustable height by means of a low voltage (24 V) foot switch. Sections width 120 cm. The head section can be adjusted to a positive angle, in the middle up to 90 degrees; gas-spring assisted. A series of accessories are available for use with the table, particularly to better restrain the patient while performing the exercises. Possibility of choosing the upholstery among 24 colors. Safe working load 250 kg

Suitable for R.I.C. Rehabilitation

MetodicaRIC
Riabilitazione Intensa Continua

4

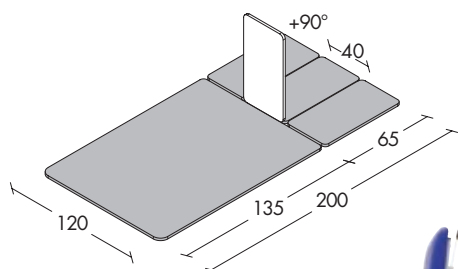

Video showing patients undergoing Continued Intensive Rehabilitation treatment according to ASIA impairment scale under official certification.



ACCESSORIES SPECIFIC TO BOBATH S RIC120 TABLE

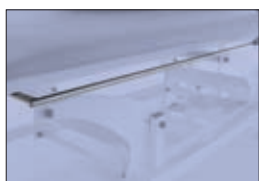

AC0009

STRAP BARS

Set of 4 bars for attaching the restraining/safety straps code AC0015



AC0015

FASTENING STRAP

This is a 240 cm long strap that can be used with the Bobath RIC 120 to the purpose of securing and/or restraining the patient while performing the exercises.

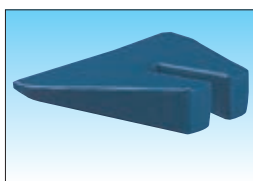

AC0025.W ?

FACE DOWN PILLOW

Used on treatment tables not provided with a breathing hole.



AC0039

ADDITIONAL HAND SWITCH - 1

Control for adjusting the height on both sides.



AC0042

HEAD / TRUNK SUPPORT

To be fitted on the adjustable headrest of the Bobath RIC 120 table. Helps restrain and support the patient when in seated position.

? CHOICE OF UPHOLSTERY COLOR - Important: always specify the upholstery code along with the chosen item when this option is available.





AC0100.01 R.I.C. STANDING FRAME

With this standing frame the patient can reach the upright position aided by the therapist. This equipment was conceived for use in combination with the basic frame code RIC 0100.01, thus widening the range of possible exercises in this posture too.

It is provided with a series of supports so the patient can maintain an erect posture, with support elements for the arms and restraints for the pelvis and trunk, to be used on a case by case basis. A further upper support for the arms is also available for order under accessory code AC0119.

The footplate features a special foot restraint system that allows moving each foot forwards and sideways independently and according to the exercise to be performed. This device can also be excluded through a lateral rotation adjustment which gives the patient in erect posture a wider range of movement with the lower limb in abduction and along the antero-posterior axis. The footboard is provided with a small castor to move the equipment more easily.

Dimensions 120 x 121 x 225 h cm

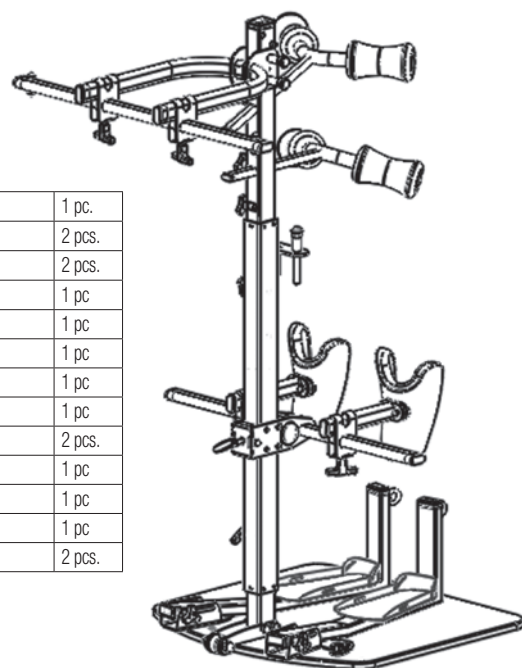

Standard Configuration

Lower base	1 pc.
Horizontal foot system	2 pcs.
Adjustable bars system	2 pcs.
Movable crossbar for sides	1 pc
Central column	1 pc
Pusher assembly	1 pc
Arm support set	1 pc
Knee pad set	1 pc
Harness hooks	2 pcs.
Castors	1 pc
Restraining strap for torso	1 pc
Pelvic harness	1 pc
Adjustable bar	2 pcs.

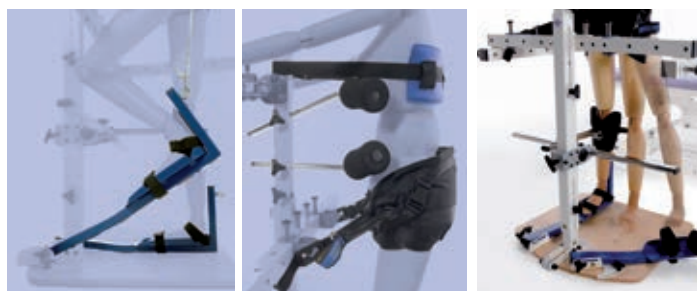

ACCESSORY SPECIFIC TO THE STANDING FRAME



AC0119 HAND GRIP SUPPORT

It can be fitted on the standing frame code AC0100.01 to provide further support to the upper limbs when deemed appropriate. The accessory that rotates nearer/farther from the patient is only suitable for tetraplegic patients.

COMMON ACCESSORIES FOR THE R.I.C. MOTOR REHABILITATION STATION

The R.I.C. motor rehabilitation station can be easily integrated with other accessories to widen the range of possible exercises or simplify the therapist's work.



AC0101 ADJUSTABLE BAR

This is a basic element that can be fitted with other accessories to perform various exercises. Please note that the standard supply for the basic frame - code RIC 0100.01 - already includes 2 pieces, and 2 pieces are supplied with the standing frame - code AC0100.01.



AC0102 MOVABLE CROSSBAR FOR SIDES

This is a basic element that can be fitted with other accessories to perform various exercises. Please note that the standard supply for the basic frame - code RIC 0100.01 - already includes 2 pieces, and 1 piece is included in the standing frame - code AC0100.01.



AC0103 SWIVEL PULLEY

This is a pulley that connects the body region to be treated and the corresponding weight or counterweight by means of a cord. In particular, it allows for creating exercises with personalized work angles by varying its position. As a result, it provides the highest flexibility of application. Please note that the standard supply for the basic frame - code RIC 0100.01 - already includes 6 pieces.



AC0329 R.I.C. QUICK-RELEASE HANDLE

This can be easily fitted to the frame's basic elements, and it provides a safe hold while performing the exercises. Please note that the standard supply for the basic frame - code RIC 0100.01 - already includes 2 pieces. It can be ordered as a single item.



AC0110 ARTICULATED FOOTPLATE

This articulated footplate provides support/restraint/posture to the feet while exercising with the R.I.C. rehabilitation station. Please note that the standard supply for the basic frame - code RIC 0100.01 - already includes 2 pieces. To be ordered as a pair.



AC0106 SLIDE SYSTEM

The slide system consists of a frame with seat, two slide rails and a movable crossbar for the sides (ref. code AC0102). This device makes it possible to perform all those exercises that require a seated position on a sliding plane. We recommend using this system together with the articulated footplates, accessory code AC0110.



AC0107 VERTICAL FOOT SYSTEM

This is to exercise with the lower limbs in suspension, with the patient in a clinostatic or in a seated or semiseated position. It is fitted to the base frame by means of the upper movable crossbar. To be ordered as a pair.



AC0112 PEDAL EXERCISER - FOR UPPER LIMBS

It enables users to exercise the upper limbs from a clinostatic or a seated position. The pedal exerciser must be fitted to the "adjustable bar" (ref. code AC0101), provided this is free (i.e. not engaged in other configurations).



AC0113 PEDAL EXERCISER - FOR LOWER LIMBS

It enables users to exercise the lower limbs from a clinostatic or a seated position. The accessory can only be used when fitted to another accessory - code AC0112 Pedal exerciser for upper limbs. It consists of two footplates and an elongated support bar.



AC0114 FOREARM SUPPORT

It consists of a fastening system to the frame and the respective forearm support that helps select the activity. To be ordered as a pair.



AC0117 SET OF HARNESES The standard series consists of the following elements: knee supports (1 pc), cross-over support strap (1 pc), plain support strap (1 pc), leather wrist straps (1 pair), leather ankle support (1 pair), hand gauntlet (1 pair), wrist supports (1 pair). Please note that the standard supply for the basic structure - code RIC 0100.01 - already includes one set. It can be ordered as a set.



AC0120 RESTRAINING STRAP FOR TRUNK

This restrains the patient's trunk when using the standing frame, either seated or standing. Please note that the standing frame - code RIC 0100.01 - already includes 1 piece.



01426 POSTURAL SET

Series of 5 posture pillows.



AC0121 QUICK RELEASE PIN

It can be used for securing basic elements and/or accessories to the basic frame - code RIC 0100.01, or to the standing frame - code AC 0100.01. Pin length 98 mm. Please note that the standard supply for the basic frame - code RIC 0100.01 - already includes 20 pieces, and 14 pieces are supplied with the standing frame - code AC0100.01.



AC0122 RELEASE PIN FOR CHAINS

Similar characteristics as the accessory code AC0121, but designed for clipping the chains. Please note that the standard supply for the basic frame - code RIC 0100.01 - already includes 2 pieces.



07930 HANDLE 1

Please note that the standard supply for the basic frame - code RIC 0100.01 - already includes 2 pieces. Can be ordered as a single item.



09600.W ? WEDGE PILLOW

Please note that the standard supply for the basic frame - code RIC 0100.01 - already includes 2 pieces 25 x 25 x 10 h cm



09620.W ? WEDGE PILLOW

Please note that the standard supply for the basic frame - code RIC 0100.01 - already includes 1 piece. 60 x 45 x 15 h cm



11250.W ? LEG WEDGE PILLOW

Shaped pillow. Please note that the standard supply for the basic frame - code RIC 0100.01 - already includes 1 piece 77 x 50 x 20/15 h cm

TARGET AUDIENCE: The Continued Intensive Rehabilitation (R.I.C.) is a motor rehabilitation method that targets those individuals who are affected by neurological pathologies, and in particular those who are neurologically or motor impaired, and those who suffer from the outcomes of infantile cerebral palsy (I.C.P.) and cerebral hemorrhage.



IMPORTANT FOR ANYONE CONCERNED:

Several individuals living in various Italian regions have used or are using the R.I.C. method at direct expense of their Local Health Authority with or without legal action.

“...We can say that the services relating to the R.I.C. rehabilitation method fall totally within those specified by the Essential Levels of Care (1) nationally and for the Tuscany Region... and that therefore such services can be considered appropriate. ...”
 “I also confirm that the Essential Levels of Care only specify the healthcare services on a separate basis and without determining the duration of the care. Therefore, the L.E.A. tables will never specify techniques or methods that cover the set of services that make up a therapy protocol, with particular and specific times and modes of execution that vary depending on the pathology to be treated, as these can only be assessed by each doctor based on their expertise and experience. Extract from: Medical-legal considerations - Ruling from the Courts of Florence N. 254 - 16.02.05.

Note (1) - The Essential Levels of Care (Italian: Livelli Essenziali di Assistenza - L.E.A.) are the services and assistance that the National Health Service (Servizio Sanitario Nazionale - S.S.N.) has to provide for the citizens either for free or against a co-payment fee (so-called ticket), using the public funding raised with general taxation.



Video showing patients undergoing Continued Intensive Rehabilitation treatment according to ASIA impairment scale under official certification.



? CHOICE OF UPHOLSTERY COLOR - important: always specify the upholstery code along with the chosen item when this option is available.

- A
- N
- 8
- 7
- K
- S
- B
- 4
- T
- 1
- 6
- E
- Z
- G
- F
- H
- 9
- Q
- R
- 2
- 3
- L
- M
- P

R.I.C. Continued Intensive Rehabilitation - The Method

R.I.C. Exercises: they originate from the global and sequential observation of the key functions performed by a healthy individual, as they go from a lying or a seated position to standing (walking) and return to the starting position. Each movement is analytically subdivided into various exercises; these exercises have been grouped into muscle regions and split into training days.

About 150 exercises have been studied and developed. Each exercise can have several variations and be performed in different postures (lying supine or prone, seated or upright, etc.), and can be aimed at muscle recuperation/strengthening, coordination, balance or reaching more objectives at the same time.

RESULTS ACHIEVED:

The results achieved are very encouraging and, in summary, we can say that:

- All patients showed a marked improvement in the international assessment scales (A.S.I.A., F.I.M., W.I.S.C.I., Ashworth ...);
- About 95% of the paraplegics and 65% of the tetraplegics have resumed an initial therapeutic gait with small splints under the knee, tripod canes or walking frames and aided by the therapist.

For many patients, the resumed gait function can be defined as therapeutic, but, in some cases, it can also become functional when necessary;

- All patients have recovered some independence in movement and personal care by increasing their functional capabilities depending on their impairment;
- Some patients have resumed some motor and sensory activity under the lesion, while others have noticed some urological, intestinal and sexual improvements;
- Most patients are feeling more secure and have greater self-esteem as a result of gaining awareness of and strengthening their motor abilities, so much so that they can resume an acceptable working and social activity;
- All patients have no longer suffered hypokinetic pathologies and the most frequent complications;
- From a psychological point of view, those patients who were de-motivated and depressed have all regained trust in their physical and psychological possibilities by socializing with other patients and appreciating the results achieved; all these patients, stimulated by the R.I.C., have resumed their social and working life outside of the family environment and medical institutions with a marked improvement in the quality of life.



Example 1. Using ankle supports (supplied as standard).



Example 2. Using Alboland restraint straps (supplied as standard).



Example 3. Using R.I.C. handles (supplied as standard).



Example 4. Using the upper limbs pedal exerciser (AC0112).



Example 5. Using the lower limbs pedal exerciser (AC0113).



Example 6. Using the vertical foot system (AC0107).



Example 7. Using the slide system (AC0106).



Example 8. Using the R.I.C. bar with hook (supplied as standard).

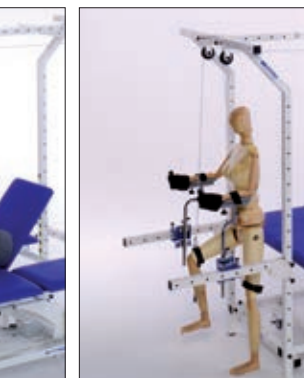

Example 9. Using the forearm supports (AC0107).

Follow us on 

Chinesport, just a click away

Chinesport's website has now also been designed and set up for those using mobile phones or iPads, not necessarily because they are out-and-about or travelling, but because they wish to know more about it while using our catalogue or other documentation. We are constantly involved in publishing new detailed information, photos (now even bigger), videos and multimedia files that are worth sharing. Finally, the website also provides a guide to putting the code together for a product made up of a number of parts.



Point, and explore the video!



REHABILITATION and MEDICAL EQUIPMENT

CHINESPORT spa
Via Croazia, 2
33100 Udine - Italy
Tel. 0432 621 621



www.chinesport.com