



Occupational Therapy

FROM CHINESPORT'S GENERAL CATALOGUE – 2015 EDITION



REHABILITATION and MEDICAL EQUIPMENT

CE

The **Chinesport** thanks all collaborators who have given their contribution to achieve the present document. In special way the Occupational Therapy program has been developed in collaboration with:

Ares Group
Ricerca & Sviluppo

At our sole discretion, the company reserves the right to change dimensions and type of construction, and to make improvements and other changes to its products. All reproduction right of all or part of the designs and illustrations are reserved throughout the whole work. All dimensions are expressed in centimetres. The printing process does not give a perfect reproduction of the colours.



The equipment illustrated in the present chapter can be subject of specific training and multilevel courses arranged by qualified professionals. So upon request it's possible to arrange events at Chinesport's head office or other site indicated by the customer.

5

Occupational Therapy

FROM CHINESPORT'S GENERAL CATALOGUE – 2015 EDITION

04 Teorema Project - Introduction

08 Configurable structures

13 Configured structures

14 Aids for insert and grasp work

18 Configuration options

20 Aids from the Magic Snake range

22 Other libraries of aids

34 Ergo Mobile station

35 Posture Monitoring Feedback

39 Instrumental evaluations

40 Occupational tables

42 More options

*'The man, through the use of his hands
as they are energized by mind and will,
can influence the state of his own health'*
(Reilly, 1962)

Teorema Project Introduction



“The main objective of occupational therapy is enable people to TAKE PART in everyday activities to the best of their abilities. Therapists guide patients in identifying those activities that are more difficult for them and finding possible solutions, using objects or strategies to compensate for or modify the activity. Upper limbs are extremely complex and represent one of the bigger challenges in rehabilitation, whether due to infantile cerebral palsy, Klumpke paralysis or any articular limitations caused by chronic inflammatory process such as in cases of rheumatoid arthritis and/or fibromyalgia. Even a simple peri-arthritis or tendonitis can be the cause of significant limitation in everyday activities. The number of even relatively young individuals affected by hemiparesis following a stroke is on the rise, as are demyelinating diseases and cases of multiple sclerosis, with all the issues deriving from having an abnormal control of the limbs. In order to improve the patient’s quality of life as well as for those who care for him/her daily, therapy efforts must try to achieve the highest results. To this end, the therapist needs a series of objects to both test patient’s capabilities and difficulties in performing various actions, and to progressively train him/her to overcome them. It may be necessary to repeat the same exercise several times to obtain meaningful results, so significant help comes from having an availability of tools that can be used without the constant presence of a professional. Reduced time and space, combined with a lack of suitable equipment that is easy to use, is a frequent cause for frustration both among patients and carers, and dramatically reduces the chances of recovery. Often an experience of unsuccessful attempts at using everyday objects or games stops any other further attempt, limits the acquisition of new skills and reduces the possibility of self-sufficient activities, increasing the need for assisted care. A patient starting occupational therapy expects an exercise and training programme, with an active role in therapy, and often expects to recover that function.”



The video shows an original exercise that uses metal discs, with magnetic support elements. Its flexibility when it comes to using it is confirmed by the aid and creativity the therapist can exercise in setting up the various tasks.

" ... For patients who have not yet had the chance of processing a trauma, as is the case after a stroke, it may be difficult to have a sense of reality regarding the damage. This is true for both limitations and residual capabilities. For a patient, it is difficult to understand the possible "adaptations" and compensations. Motivation is greatly increased when treatment occurs in an environment containing a wide range of equipment that physically tests every residual movement, even when limbs are severely affected. For example, making a patient aware of what type of grasp they are using or how they are able to bend or extend their elbow or wrist, or to what extent they are able to move their shoulder, is key to create a strong, comprehensive treatment and to set up a range of exercises that PREPARE them to re-gain independence when using various objects that are useful for home, work and spare time. Using "neutral" objects and materials that are removed from any emotional significance because they are either non-personal or non-evocative, is more likely to push you into testing yourself, experiencing satisfaction at every small progress. These modular aids can also be used in limited areas and suit every need, enabling an accurate evaluation and to achieve gratifying results for both the therapist and patients, whether they are children, adults or elderly, whether they suffer from musculoskeletal or neurological limitations or affected by attention deficit disorders or intellectual disorders. Seeing how an upper limb can recover its capabilities and be used to gain more independence in everyday tasks, even after a trauma, neurological condition, arthritis, arthrosis or stroke, improves the patient's general well-being and brings joy to family members and therapists too. It is in this context that, after many years of effort in rehabilitating patients suffering from complex conditions and multiple disabilities, we have further extended our Teorema programme with the critical contribution from patients and their families."

*Dr. M. Elisabetta Gaiatto, Physiatrist and Orthopaedist;
Santa Baldo, Physiotherapist; Dr. Manuele Meneghel,
Occupational Therapist.*

(The TEOREMA project is continually developed together with rehabilitation professionals and occupational therapists having a long experience).





THE LIBRARIES

A series of work aids is proposed that are used to simulate different activities in daily life. These aids have been grouped into various libraries - "Grasp and Insert", "Magic Snake", "Manipulation Skills", "Domestic Activities", "Clothing", and "Food".

A series of icons is used, along with the presentation of each individual aid, to facilitate which library it belongs to, as well as other specific attributes.

The base modules used to attach the aids are made from highly resistant, anti-bacterial materials of the highest quality, made to last over time without any alteration; in particular, they are resistant to water and UV rays and can be easily disinfected.

EXAMPLE - Two configurable "ergo 100" panels joined using the joining set

Joining of two ERGO 100 panels (ref. code AR10003) using the joining set (ref. code AR10005). Using two panels in line with one another can make it possible to move the individual work modules sideways, by sliding them in the guides, without removing them from the wall.

AID LIBRARIES



GRASP AND INSERT



MAGIC SNAKE



MANIPULATION SKILLS



DOMESTIC ACTIVITIES



CLOTHING



FOOD

USING THE AID



USE WITH ONE HAND



USE WITH TWO HANDS

Modularity

Modularity comes into its own with the variety of solutions proposed for executing occupational exercises, which can be done in a standing position or seated. Also panels are offered for wall-mounting, which can be configured and are of various types. These panels can be fitted with the most useful aids in each case, chosen from the theme libraries available. Using the same space for the wall panel it is therefore possible to vary the therapeutic exercises the patient is to carry out. Minimal time is required for the therapist to set up the panel, and no tools are required. The presentation below for each aid includes information in the form of an icon that indicates whether the aid can be positioned vertically, horizontally, or at an angle.



Flexibility

This results from the need to provide the patient with the possibility of making the exercise better suited to their limitations. Once the aid to be worked with has been identified, it can be positioned at the correct height. The possibility of positioning the individual work aid higher up brings gradualness and progression to the exercise, as the patient improves. Also, the same work aid can be used in a horizontal position or inclined between 0° and 90°.



Teorema Project Configurable structures



AR10007 TILT ERGO

This structure makes it possible to vary the tilt on an individual work aid by 0° to 90°, and can be adjusted to any intermediate position. This makes it possible to extend the opportunities for executing the same exercise in terms of commitment and difficulty. Also, it can be used horizontally, with the patient sitting, or vertically by fitting the element to a configurable ERGO 100 panel while the patient is standing.

The structure is in painted metal, while the base is in anti-bacterial polyethylene that is water and UV ray resistant and easy to sterilise.

Dimensions: (cm) 46 x 26.5 x h 14; Weight: 4 kg



AR10026 TILT ERGO 2

It can either be used horizontally, or vertically, by fitting a configurable ERGO 200 panel. However, we recommend not using it vertically if aids are heavier than 3 kg. It has a larger square base that provides total stability for use with any type of exercise aid. This item can also be used as tilting storage tray or as computer keyboard stand. Dimensions: (cm) 46 x 38 x h 14 ; Weight: 5.2 kg

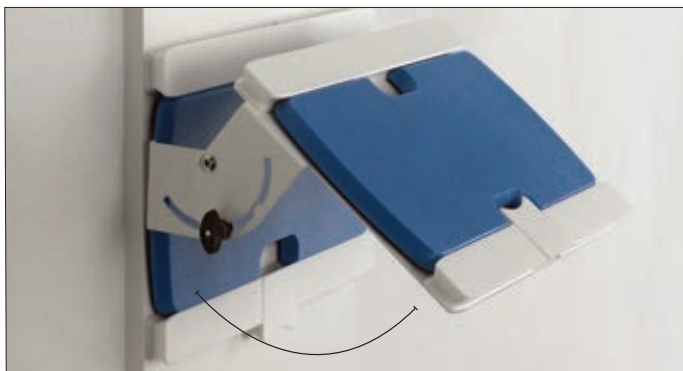
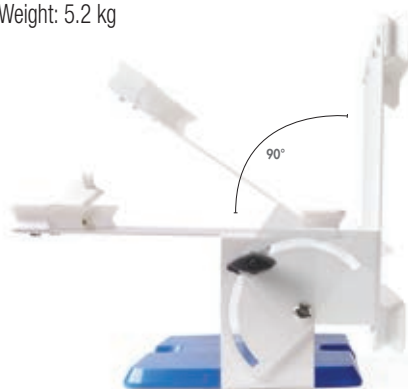

Rotation through 90° of the TILT ERGO structure fitted to a configurable ERGO 100 wall-mounted structure.- Makes it possible to change the tilt on a single work aid while exercising in an upright position.



Sequence showing how to insert a sample module in the TILT ERGO structure. The task of changing the work aid when necessary is quick and easy.

AR10006 ERGO TABLE

Individual work aids can also be used while seated, for example adding this specific fold-away, wall-mounted table. This service table blends in with any other vertical structures available, in terms of materials and aesthetic characteristics, and can be combined with one of them.

The structure is in painted metal, while the worktop is in anti-bacterial polyethylene that is water and UV ray resistant and easy to sterilise. The worktop is also shaped to make it more ergonomic for cases of use by patients in wheelchairs. When not in use the service table can be folded away. It comes with specific hardware.

Dimensions: (cm) 80 x 61.5 x 73.5 h; (folded down, (cm) 80 x 12.5 x 77 h);
Weight: 16.5 kg

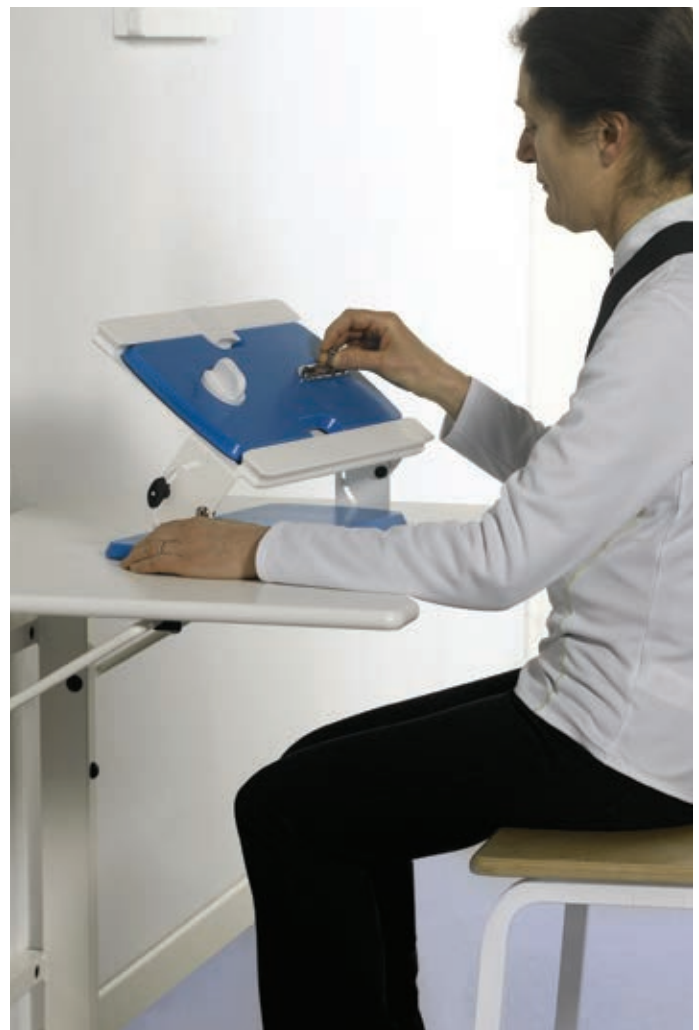

The TILT ERGO structure can be fitted to a configurable wall structure code AR10003 ERGO 100. We have also provided for the possibility of changing the angle of an individual aid during exercise in an upright posture.

The same exercise aid or a different aid can be used either horizontally or with a variable tilt angle using the TILT ERGO element. ref. code AR10007.

Teorema Project Configurable structures

AR10003 ERGO 100

This is a configurable panel that can be attached to the wall. The panel is designed to hold up to four exercise modules with a rectangular base, chosen among our available libraries. No tool is required to reposition an individual module at a different height. The module is inserted by sliding it into specific guides, and easily locked in place using a lever device. The possibility of positioning the module higher up allows for adapting the exercise gradually and progressively according to the patient's improvement. The structure is supplied with specific hardware.

Dimensions: (cm) 39.5 x 4 x 86 h; Weight: 5 kg



Easy insertion of the aid and tool-free locking system once positioning has been completed.



AR10025 ERGO 200

This is a configurable panel that can be attached to the wall. The panel is designed to hold up to two exercise modules with a square base, chosen among our available libraries. Similarly to ERGO 100, each individual module can be used at a different height and secured using a lever system. The structure is supplied with specific hardware. Dimensions: (cm) 39.5 x 4 x 86 h; Weight: 4.8 kg



Rotation through 90° of the TILT ERGO structure fitted to a configurable ERGO 100 wall-mounted structure. - Makes it possible to change the tilt on a single work aid while exercising in an upright position.



AR10005 JOINING SET

Two panels that are already configured (ERGO 10 and ERGO20 models) or can be configured (ERGO 100 or ERGO 200 models) can be put side by side, precisely, using two joining elements made of anti-bacterial polyethylene that is water and UV ray resistant. Joining set is supplied with specific hardware.

Dimensions: (cm) 85 x 1.5 x 5 h (individual piece); Weight: 0.95 kg (pair)

CONFIGURABLE "ERGO 100" PANELS AT VARIOUS HEIGHTS

A system comprising two separate ERGO 100 (ref. code AR10003) panels set up at different heights within a recommended range of 72 to 200 cm. This makes it possible to do the same exercise at different heights, to suit the patient's functional limitations, or progress as they improve. This situation makes it possible to run workout sessions with a number of users at the same time and a larger number of aids.



We would like to stress that the same exercise can be performed fitting the aid at different heights by means of a configurable panel code AR10003 ERGO 100. This creates a programme with an increasing level of difficulty that follows the patient's improvement trend.

Teorema Project Configurable structures

AR10004 ERGO 400

This is an advanced wall-mounted panel, set up for using a single work aid at a time. The module is inserted by sliding in specific guides, and locked in place using a lever device. The aid can now be easily adjusted in height without any tools or repositioning, making variations and progression possible when executing the same exercise. The adjustment system is simple and does not require any force on the part of the therapist. The aid can therefore be adjusted between 54 and 200 cm, at 2.5 cm intervals. The aid attachment also makes it possible to do the same exercise at a tilt of 0° to 90°, from vertical to horizontal. The work module can be freely chosen from the libraries available. The structure is in metal and is supplied with specific hardware.

Dimensions: (cm) 46 x 24,5 x 202 h; Weight: 32 kg

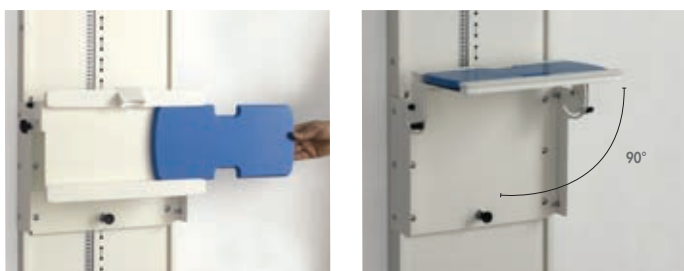

"Our main concern is to reach the predefined goal, which is to interact with the cup, take the cup and place it down, but the patient's task is to complete this movement creating a pattern that requires the upper body to be stabilised so that the arm is free to perform this functional task. Keeping the antenna angle stable, the tool height is modified, and clearly if the patient reaches a height without triggering the sound feedback, it means they have gained greater skills. The patient is asked to concentrate his/her attention to more than his/her end target." Alessandro Crippa - Rehabilitation Therapist (also see position feedbacks for postural control)

AR10001 ERGO 10

This is a wall mounted panel that is fitted with a library of 7 aids to simulate everyday domestic activities. In particular, the configured panel consists of the following aids: Window handle, Door handle, Rotating latch, Sliding latch, Switch, Electric plug with adapter, Wall spiral. The already fitted panel is supplied with specific hardware. Dimensions: (cm) 39,5 x 9 x 89 h; Weight: 5 kg



5



AR10002 ERGO 20

This is a wall mounted panel that is fitted with a library of 7 aids to simulate everyday dressing activities. In particular, the configured panel consists of the following aids: Series of buttons, Series of press studs, Series of horizontal laces, Series of criss-cross laces, Buckle with quick release adjustable belt, Zip kit, Worm screw with adjustable resistance. The already fitted panel is supplied with specific hardware. Dimensions: (cm) 39.5 x 9 x 89 h; Weight: 5.5 kg



OCCUPATIONAL THERAPY

Teorema Project Aids for insert and grasp work

AR10027 OLIMPIC DISCS - SMALL BOARD

The rectangular base panel is supplied together with 4 cylinders and 4 contoured discs made from different coloured plastic material. Cylinders can be freely inserted into the 30 holes arranged in the base, while discs can be fitted on the cylinders. The half-moon discs have a grip that is easier to grasp, using the hand in various positions and improving dexterity. The size has been designed to promote a grasp with an almost open hand and extending the metacarpophalangeal and Interphalangeal joints. Inserting the discs into the pins helps practise the pronosupination of the wrist. You can also work on recognising, matching and seriating the various colours. With a panel placed on the wall, you can also exercise elbows and shoulders. For those who need to work on a sloping plane, the panel can also be held on the knees or in the hands of the therapist, who is in front of the patient. The standard set-up for the exercise aid can be subsequently integrated with other similar or different components from the available choice of accessories. Dimensions: (cm) 39.5 x 17.5 x 10.5 h; Weight: 2 kg

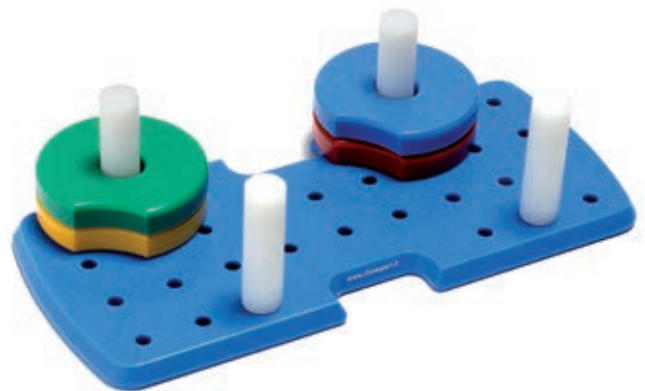

AR10028 OLIMPIC DISCS - LARGE BOARD

The panel has a larger, square base compared to item AR10027, and is supplied together with 8 cylinders and 8 contoured discs made from different coloured plastic material. Cylinders can be freely inserted into the 75 holes arranged in the base, while discs can be fitted on the cylinders. The discs have a grip that is easier to grasp, using the hand in various positions and improving dexterity. Starting by inserting the cylinders away from each other - even two cylinders will do -, the exercise difficulty is increased adding more cylinders on, so that the cylinder or discs need to be picked up in a "crowded" environment that makes the task more challenging. Discs can also be fitted vertically between cylinders and/or be moved as if they were vehicles on a track; they can also be placed on top of the pins in the shape of a stilt-house. The standard set-up for the exercise aid can be subsequently integrated with other similar or different components from the available choice of accessories. Dimensions: (cm) 40.5 x 38 x 10.5 h; Weight: 4.1 kg



A large variety of exercises can be done for gripping, insertion, distinguishing colours, or calculation tasks, to create "designs" or to pass elastic ribbons between the cylinders inserted into the base



AR10029 MAGNETICS GAMES - SMALL BOARD

The rectangular base panel is supplied together with 8 pins with a magnetic top, and 8 different coloured metal discs.

This game is particularly enjoyable and versatile, as it can also be used for colour recognition as well as to help improve calculation skills and create shape and colour sequences. The magnet helps to pair the half moons, even when the patient experiences serious difficulties with basic tasks. Lifting the metal disc requires greater strength and accuracy. Plates can be brought closer vertically (and dropped down - a very appealing game) or grabbed horizontally. Lifting the plate helps with tasks like pulling the tab in a drinks can, and using coins or buttons. Plates can also be removed with the open palm facing upwards. The special half-moon shape provides an easier grip and an extremely innovative opportunity for interaction. The standard set-up for the exercise aid can be subsequently integrated with other similar or different components from the available choice of accessories.

Dimensions: (cm) 39.5 x 17.5 x 10.5 h; Weight: 1.4 kg



AR10030 MAGNETICS GAMES - LARGE BOARD

The panel has a larger, square base compared to item AR10029, and is supplied together with 16 pins with magnetic top, and 16 different coloured metal discs. Magnetised pins can be freely inserted into the 75 holes arranged in the base, while metal discs can be fitted on or removed from the pins.

This exercise aid offers a wide and varied range of exercises as described under item AR10029, but with a greater number of elements.

The standard set-up for the exercise aid can be subsequently integrated with other similar or different components from the available choice of accessories.

Dimensions: (cm) 40.5 x 38 x 10.5 h; Weight: 4.1 kg



The video shows an original exercise that uses metal discs, with magnetic support elements. Its flexibility when it comes to using it is confirmed by the aid and creativity the therapist can exercise in setting up the various tasks.



Teorema *Project Aids for insert and grasp work*

AR10031 FANTASY STICKS - SMALL BOARD

The rectangular base panel is supplied together with metal cylinders that can be inserted freely into the thirty holes arranged in the base. It was devised for hand-eye coordination, to improve dexterity and/or use the correct strength when inserting things. It can also be used to weave coloured ribbons or elastic bands through the cylinders. It is to practise accuracy with movements and the strength required to either extract the cylinders or push them into the holes. The standard set-up for the exercise aid can be subsequently integrated with other similar or different components from the available choice of accessories. Dimensions: (cm) 39.5 x 17.5 x 10.5 h; Weight: 2 kg



AR10032 FANTASY STICKS - LARGE BOARD

The panel has a larger, square base compared to item AR10031. It comes with 16 metal cylinders that can be inserted freely into the 75 holes arranged in the base. This aid enables the patient to practise better coordination and use of strength when inserting the cylinders. More tasks can be devised, for example weaving coloured ribbons or elastic bands through the cylinders already inserted, or even counting, playing a line-them-up game, creating various shapes. The standard set-up for the exercise aid can be subsequently integrated with other similar or different components from the available choice of accessories. Dimensions: (cm) 40.5 x 38 x 10.5 h; Weight: 4.1 kg



Spheres: some proposed exercises - "Facilitate vertical gripping, as well as side-on gripping, resting the hand on the surface. I can play a game, arranging them on the same line, or alternating. I can use smaller spheres. It can also be used for insertion with the arm supported, or higher up."



AR10047 TRACKS - SMALL BOARD

This aid comes with two different shaped aluminium pins, two different sized spheres, and one plastic cylinder. These elements offer various handles and types of "grip".

- The two small aluminium pins are to perform accurate finger movements (one of these versions can replicate a key grip);
- The two spheres are also suitable for a child to "grasp" (for example, it can be grabbed using the palm of the hand);
- The cylinder with 2.5 cm diameter and 9 cm height is for grasping with the palm or finger tips depending on the patient's capabilities or the movement you wish to perfect.

This exercise aid improves the use of fingers, wrists, upper arms, hand-eye coordination both in adult and adolescent patients who need to learn and practise skills they have never used before or have lost after a trauma injury to the limbs or due to neurological lesions. Through a movement that is restricted to a track, the upper limb can move following a varied motor programme, while also working on retracting the shoulder-elbow-wrist joint. Helps improve writing skills and using keys in locks.

Dimensions: (cm) 39.5 x 17.5 x 6 h; Weight: 1.3 kg



AR10048 TRACKS - LARGE BOARD

This aid comes with two different sized aluminium pins, two different sized spheres, and one plastic cylinder as in item AR10047, however the base module has a larger square shape, with several patterns or possible paths. The elements offer various grips and types of "grasp".

It improves the use of fingers and wrists, both in flexo-extension and pronosupination, and improves the use of elbows in flexo-extension, hand-eye coordination both in adult and adolescent patients who need to learn and practise skills they have never used before or have lost after a trauma injury to the limbs or due to neurological lesions. Helps improve writing skills and using keys in locks.

Dimensions: (cm) 40.5 x 38 x 6 h; Weight: 2.4 kg





The gradualness and progression of difficulty of executing the planned - "Vertical gripping, horizontal gripping, as well as putting the handle between the fingers, depending on how the patient is able to grip it, thereby being able to grip and push it. You leave them free to do the various tests in the easiest way for them."



Teorema Project Configuration Options

CHOOSE YOUR PREFERRED CONFIGURATION

The following elements require a different technique and skill to grasp and insert. These elements can be considered as accessories, which means that they integrate the exercise aid kits already described in the previous pages, or they can also provide the professional with more options for free configurations.

REHABILITATION GOALS:

- Grasp: terminal digital, digito-lateral
- Joint mobility: interphalangeal joints, metacarpophalangeal joints
- Muscle strength (when inserting into holes and removing from holes)
- To practise grasping knobs
- Cognitive functions: orienting the hand in space, hand-eye coordination
- A variety of geometrical shapes can be created

BASE PANELS:

The base modules used to attach the aids are made from highly resistant, anti-bacterial materials of the highest quality, made to last over time without any alteration; in particular, they are resistant to water and UV rays and can be easily disinfected.



AR10044 – HOLE BASE – SMALL BOARD

Base module with a smaller, rectangular shape, with thirty holes to insert the elements freely. This module takes little space, it can be easily transported and used for therapy session at the patient's home. Dimensions: (cm) 39.5 x 17.5 x 1.7 h; Set weight: 0.9 kg



AR10045 – HOLE BASE - LARGE BOARD

Base module with a larger, square shape, with seventy-five holes to insert the elements freely. This module allows you to fit more elements, for a wider choice of exercises. Dimensions: (cm) 40.5 x 38 x 1.7 h; Set weight: 2.1 kg



AR10033 – OLIMPIC DISC SET 1

A series of eight cylinders and eight discs made from special plastic material as the base modules. Cylinders can be inserted into the base or slotted one on top of the other, while discs can be inserted into the cylinders. The cylinders' diameter is 2.5 x 9.5 h cm, while the discs' diameter is 11 x 1.9 h cm. Set weight: 1.8 kg



AR10034 – OLIMPIC DISC SET 2

A series of eight discs in four colours. The half-moon discs have a grip that is easier to grasp, using the hand in various positions and improving dexterity. They can be slotted into 2.5 cm diameter cylinders that, in turn, can be inserted vertically on a base. The discs' diameter is 11 x 1.9 h cm. Set weight: 1.3 kg.



AR10038 – FANTASY STICKS SET 1

A series of sixteen aluminium spheres with 15 mm diameter that can be inserted into a base module. This type of cylinders cannot be stacked on top of each other. Cylinder dimensions: diameter 1.5 x 9.5 h cm; Set weight: 0.7 kg



AR10039 – FANTASY STICKS SET 2

A series of fifteen aluminium spheres with 15 mm diameter that can be inserted into a base module. Unlike item AR10038, this type of cylinder offers the option of inserting them one on top of the other. This means that the patient can develop a vertical structure as well. Cylinder dimensions: diameter 1.5 x 9.5 h cm; Set weight: 0.7 kg



AR10035 MAGNETIC GAMES SET 1

A series of sixteen pins with a magnet at the top and an equivalent number of different coloured metal discs. The magnet helps to pair the half moons with the pins, even when the patient experiences serious difficulties with basic tasks. Pins are made from special plastic material and can be inserted into a base module. The pins' diameter is 2.5 x 3.5 h cm, while the discs' diameter is 4.5 x 0.3 h cm. Set weight: 0.8 kg



AR10040 – FANTASY STICKS SET 3

A series of sixteen cylinders made from special plastic material, with 25 mm diameter. These cylinders can be inserted into a base module, but they cannot be stacked on top of each other. Cylinder dimensions: diameter 2.5 x 9.5 h cm; Set weight: 0.8 kg



AR10041 – FANTASY STICKS SET 4

These cylinders can be inserted into a base module or even one on top of the other, i.e. they can be stacked in a different way than item code AR10040. This means that the patient can develop a vertical structure as well. Cylinder dimensions: diameter 2.5 x 9.5 h cm; Set weight: 0.8 kg

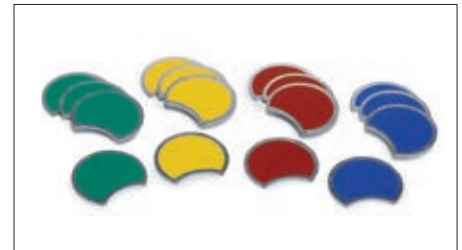

AR10036 MAGNETIC GAMES SET 2

A series of sixteen half-moon metal discs in four colours. Suitable for use with patients who lack strength in their grasp and with hand sensory deficiencies. The grasp can be terminal digital or digito-lateral, involving the distal phalangeal and wrist joints. They can be used with magnetic pins that facilitate pairing and can, in turn, be inserted into a base module. The discs' diameter is 4.5 x 0.3 h cm. Set weight: 0.4 kg



AR10042 – SET OF SPHERES ø 20 mm

A series of sixteen spheres made from plastic material with 20 mm diameter that can be inserted into a prearranged base module. The spheres enable to practise the distal finger grip, thumb-index finger or thumb-index finger with the help of the other fingers. Sphere dimensions: diameter 2 cm; Set weight: 0.2 kg



AR10043 – SET OF SPHERES ø 40 mm

A series of sixteen spheres made from plastic material with 40 mm diameter that can be inserted into a prearranged base module. The spheres enable to practise the distal finger grip, thumb-index finger or thumb-index finger with the help of the other fingers. Item AR10042 can also be beneficial due to its smaller diameter spheres. The various sphere sizes are conceived for different end users, i.e. children and adults. Sphere dimensions: diameter 4 cm; Set weight: 0.7 kg



AR10037 MAGNETIC GAMES SET 3

This is a series of ten metal discs with a special, rewritable white film. They can be used to write numbers and letters individually, or in groups as an alphabet library, or in groups by words, to write numbers, draw shapes and mix everything with the colours. Turn them over, and they can be used as a memory game, trying to remember what was written on the other side. They come with dry-erase markers. The discs' diameter is 5 x 0.3 h cm; Set weight: 0.5 kg

Teorema Project Aids from the Magic Snake range



“The aids from the MAGIC SNAKE range are especially suitable for patients with difficulties in pronosupinating the forearm; they have also proved to be effective when mounted in the shape of a semi-circle, including after Klumpke paralysis and to improve shoulder mobility, by sliding the various components along the supporting tube. It can also be used for individuals who experience pain at the wrists or repetitive and prolonged use of wrists and fingers (e.g. mouse and PC). Fitting and removing the hooks also facilitates the flexo-extension of the wrist.”

Dr. Elisabetta Gaiatto, Specialist Psychiatrist and Orthopaedist.



AR10053 MAGIC SNAKE 1

This aid primarily consists of a rectangular base module with a flexible plastic tube that can be bent and shaped as you wish to create the desired shape/path. The tube ends can then be slotted into the base. The kit also includes a “goose bill” hook, a ring and a disc, all with different sizes, grips and weight, that can be guided along the path defined by the shaped tube. This aid offers complete freedom in creating different movements and grips.

Dimensions: (cm) 39.5 x 17.5 x 40 h; Weight: 1.5 kg



The picture shows the exceptional flexibility of the plastic-coated tube that comes as standard with all the work aid kits from the MAGIC SNAKE range, which means that it can be easily adapted to the path shape preferred by the therapist. Once set, the shape remains the same until the next change.



Various exercise strategies and settings can be used so that the patient makes movements with their hand, following the shape put on the tube by the therapist.



In our ongoing quest to improve our TEOREMA project, we would be grateful if you could let us know about any specific needs that are currently not covered by the available aids. Feel free to send us your request by sending an e-mail to: info@chinesport.it. We will evaluate whether your request is for a customised solution only or if it can be extended to standard production.



AR10054 MAGIC SNAKE 2

Unlike item AR10053, this aid consists of two rectangular base modules with a rigid plastic tube that can be bent and shaped as desired. The tube ends can then be slotted into the bases. The kit also includes a "goose bill" hook and a ring that can be guided along the path defined by the shaped tube. This aid offers complete freedom in creating different movements and grips. Dimensions: (cm) 39.5 x 44.5 x 40 h; Weight: 2.7 kg



AR10055 MAGIC SNAKE 3

This aid consists of a larger, square base module with a rigid plastic tube that can be bent and shaped as desired to create the preferred shape/path. Its functional characteristics and accessories are the same as for item AR10053. This aid offers complete freedom in creating different movements and grips. Dimensions: (cm) 39.5 x 17.5 x 40 h; Weight: 1.5 kg





AR10008 HORIZONTAL SPIRAL

The aid exercises the subject in prono-supine positioning hand movements. Specifically, the subject is asked to keep the ball between the first three fingers on the hand and guide it over the sinusoidal path. This exercise means that the large prono-supine positioning joints in the forearm are used to the maximum. It is therefore useful to monitor the patient's behavior while executing this task. Any incapacity to explore the maximum levels of supine positioning could be compensated for by bending the trunk on one side, while limitation of prone positioning will cause early and excessive movement of the arm away from the trunk. Dimensions: (cm) 39.5 x 22 x 32 h; Weight: 2.5 kg



AR10009 VERTICAL SPIRAL

An instrument similar to the horizontal spiral, but different in that this exercise calls for greater involvement of the upper limb. In addition to prone-supine positioning movements of the forearm on must, in fact, use arm movements that must guide the hand in the twisting movements. The aim of the task is to exercise the upper limb in a complex movement that calls for a good level of skill and fluid movements. Dimensions: (cm) 39.5 x 17.5 x 28.5 h; Weight: 2 kg





AR10010 OBLIQUE SPIRAL

This aid involves work on the horizontal plane. The elbow bends and extends to reach the curves on the flexible element. Inclined radial / ulnar movements are required to get past them. Positioning on a vertical panel: in this case the instrument lies on the vertical plane. This instrument is therefore similar to the vertical spiral, but differs in that positioning it at various heights and working in an upright position, obliges the subject to achieve greater bending and extension of the arm.

Dimensions: (cm) 39.5 x 29 x 10 h
Weight: 1.8 kg



AR10011 WORM SCREW

An aid that is useful for a patient to work independently in order to recover joint function between the interphalangeal on the finger.

Executing this task correctly calls for the capacity to open and close the finger, while maintaining a set degree of pronation and supination of the hand. To do this, the subject must combine adequate joint movement and muscular function, with good coordination of hand movements. The aim is to get to know the fine movements of their hands and how to use them better. This aid provides the possibility of making a small adjustment to the resistance to rotating the bar. This has 2 different diameters, in order to make it more suited to the type of exercise / patient.

Dimensions: (cm) 39.5 x 17.5 x 15 h
Weight: 2 kg



AR10012 FLEXO EXTENSION

The patient puts their forearm into a support that holds it in place. The fingers are connected to the elastics by means of fixings put over the fingers like rings. A sliding adjustable system makes it possible to keep the optimum 90° angle between the phalanxes and the elastics. The tension in the elastics keeps the fingers' flexing muscles extended, changing the passive rigidity over time. Exercises can be done with concentric, eccentric and isometric contractions by the flexing muscles. The supports are in chromed metal, while the finger inserts are in atoxic imitation leather, and both the length and resistance can be adjusted in each individual finger elastic. Dimensions: (cm) 39.5 x 17.5 x 19 h; Weight: 2.3 kg

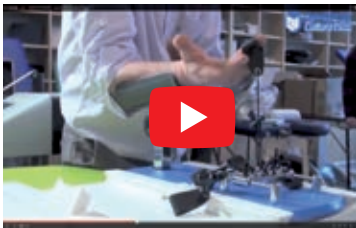

It also contains tips on how to make the best use of the equipment - code AR10002 FLEXO-EXTENSION in a wide range of exercise options



AR10014 PRONE SUPINATION

Positioned on a table: This aid is used to invite and guide the patient through prone supination tasks with their forearm. Two knobs below the equipment are used to position it correctly for the patient. The proximal support on which the forearm is placed must be adjusted to a height that keeps the shoulder in a comfortable, neutral position. By raising and lowering the adjustment element with the elbow flexed, the position is changed to extra/intra rotation of the upper limb respectively. The knob nearest to the handle is used to adjust it to the correct tilt on the prone supination plane, while the upper knob is used to adjust a system that is able to provide resistance to the movement by the patient, which can be varied in intensity. The patient is therefore asked to overcome the resistance offered by the aid, and the extent of that resistance is determined by the therapist in relation to the therapeutic goal. Dimensions: (cm) 46 x 17.5 x 19 h (can be raised to 22 cm); Weight: 2,6 kg



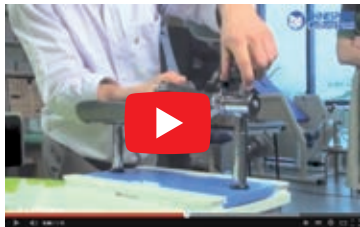

Please watch for an explanation of the various adjustments and related implications when executing the exercise. The presentation was prepared by a therapist with an extensive experience in rehabilitation.



AR10013 LADDER 10

Positioning on a table: when put up on a horizontal surface in front of the patient, the active work required in using the ladder with the fingers will involve the proximal joints, extending the elbow and flexing the shoulder. In doing this progressive task using their fingers, the patient develops fluidity and coordination, alternating a flexing movement with one finger with the simultaneous extension of the other to reach the next step. When positioned on a vertical panel, the ladder is positioned on the same axis as the support module, due to bulk considerations, and is rotated and used vertically. This is particularly useful when you wish to get the shoulder to a greater degree of flexing. When positioned on a surface at a variable tilt, the exercise proposed can be useful for teaching the patient to align their trunk correctly, in order to achieve the change in position from seated to standing upright. Patient seated a little away from the table. The aid is positioned so that it reaches the furthest reach of the fingers, with the elbow extended. Their centre of gravity is sufficiently in front of them to allow them to lift themselves up.

Dimensions: cm 39.5 x 17.5 x 4 h (closed); Weight: 2 kg



AR10050 LADDER 10 WITH HANDGRIP

This exercise aid has the same technical/functional and therapeutic characteristics as described for item code AR10013. The primary, original function of this equipment is to help mobilise fingers following the grooves, but it is also useful as an aid applied vertically on a module type ERGO 100 to help lift the shoulder. The most peculiar feature is a knob that enables the wrist and elbow to flex and extend, and the shoulder to be mobilised. The knob can be turned and makes it easier to be grasped either from above or from the side. This aid can be placed on different surfaces and at a different distance, even on the knees of a seated patient, to help move the hand and wrist, as well as the elbow and shoulder.

Dimensions: (cm) 39.5 x 17.5 x 16 h; Weight: 2.2 kg



AR10049 ROLLING WHEEL

The patient can practise performing a semi-circle or a full circle. The knob can be turned and makes it easier to be grasped either from above or from the side. This aid can be placed on different surfaces and at a different distance, even on the knees of a seated patient, to help move the hand and wrist, as well as the elbow and shoulder. Repeating the exercise provides remarkable benefits to recover mobility in the shoulder and shoulder blade even when affected by chronic periarthritis, arthrosis or rheumatoid arthritis, as well as in individuals with neurological deficiencies and muscular conditions. For those who need to work on a sloping plane, it can be held on the knees or in the hands of a therapist, who is in front of the patient. Dimensions: (cm) 40.5 x 38 x 16 h; Weight: 3.1 kg



AR10056 CLIMBY

This innovative aid makes it possible to adjust the metal structure tilt. It helps improve coordination when using both upper limbs by gradually mobilising the shoulder, elbow and wrists while keeping hold of the bar with the hands. It can also be used by individuals with serious lack of strength and resistance. Using the bar, one limb helps the other. This exercise aid is a favourite among people with spasticity or hypotonicity, periarthritis, shoulder arthrosis or hemiparesis. Dimensions: cm 43 x 38 x 64 h; folded: cm 43 x 75 x 10h; Weigh: 6 kg

The aid can be adjusted, and the 3D simulation provided here shows the lower, less bulky position, as well as a detail of the manual tilt adjustment.

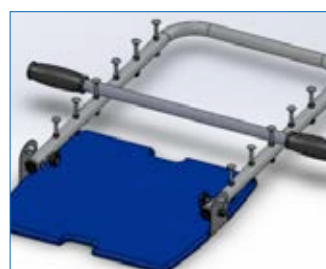



AR10052 HANGER

This aid enables to perform actions like hooking and sliding items with different grips on a bar. The basic kit has two "goose bill" hooks with through-hole, a ring and a disc. In particular, it enables to practise and simulate placing paper rolls (the bar can be removed and replaced multiple times), as well as simulate a coat hanger with the addition of hooks that can also slide along as it would happen with curtains. Dimensions: (cm) 39.5 x 17.5 x 17 h; Weight: 2 kg



AR10023 ELASTIC SLALOM

This aid is made to allow patients to exercise using "slalom" tasks between the pegs, following a sequence determined by the therapist on each occasion. Precision and coordination of movements is required to keep the elastic cord taut and to guide it during the exercise. The ring facilitates holding it. The unit has 5 plastic pegs. One of these is used to hold the end of the elastic to be "guided" as indicated by the therapist. Dimensions: (cm) 39.5 x 17.5 x 10 h; Weight: 1.5 kg





AR10051 BASKET

The purpose is to practise passing objects through a certain gap upwards and downwards, or sideways (from right to left, or left to right), as well as to try hooking up everyday objects on the edge. It is ideal when used in combination with the structure AR10004 ERGO 400 to perform exercises at different heights. It can also be used to pass different balls through the hole.

Dimensions: (cm) 39.5 x 17.5 x 26 h; Weight: 1.3 kg



AR10018 CUPS

In gripping the cup the weight of the object is used because the circumference is supported by the grip formed by the thumb and middle finger, and a hook made up of the index finger. This grip requires excellent thumb and middle finger stability, as well as the integrity of the deep flexor on the index finger and abductor on the thumb, which is essential for this task.

To grip the cup it is important to have good skill in using flexing/ extending muscles of both the hand and the rest of the upper limb in a harmonious manner, for the reaching and subsequent gripping phases. You can also work on the patient's capacity to open their hand to grip / release the cup at various heights. Common disposable plastic cups can be inserted.

Dimensions: (cm) 39.5 x 17.5 x 13.8 h; Weight: 1.3 kg





AR10015 LATCHES

A "sliding" latch (element on the left in the photo): due to this instrument's size, the patient has to have a fine grip using the first three fingers. Also they must associate a small movement in the vertical plane to free the latch and move it along the horizontal plane. The patient can also be asked to do this task without using the visual channel, which means that they must rely on tactile-kinaesthetic information. A "turning" handle (shown on the right in the photo): in this case the grip involves control with the thumb and side of the second finger. A supination and pronation rotating force is required to turn the handle.

Dimensions: (cm) 39.5 x 17.5 x 4.5 h; Weight: 1,3 kg



AR10017 HANDLES

Made up of a window handle (180° rotation about a central pin) and door handle (90° rotation about a pin to one side). Depending on how the aid is positioned on the wall panel, the latter can be used with the right or left hand.

Dimensions: (cm) 39.5 x 17.5 x 8 h; Weight: 1,5 kg



AR10024 TIGHTENING CYLINDERS

The tightening / loosening action involves a three-finger grip in which the thumb is positioned to the side, while the phalanx on the middle finger opposes the index finger. The role of counterposing the middle finger to the thumb is reinforced by the support that the third finger gets from the fourth and fifth fingers. The three different head diameters provide for increasing the complexity of the task. The entire support is made of anti-bacterial polyethylene that is water and UV ray resistant and easy to sterilise. It has 3 head diameters for varying levels of difficulty in gripping for the hand - wrist. The "heads", made of polyethylene like the support, can simulate the caps on food jars, a light bulb, gas tap, etc.

Dimensions: (cm) 39.5 x 17.5 x 13.8 h; Weight: 2,5 kg



AR10022 SCREWING IN PEGS

To do the tasks using this kit, coordinated use of both hands is essential. In this way the pressure of the thumb and index finger oppose the pulp side of the palm. This grip also coordinates the flexing gripping muscles of the first phalanx of the thumb: short flexor, first palm interosseus, and short abductor. The various shapes of the head of the screw varies the degree of ease and stability of the grip. There is also a two-handed task, in which one hand acts to secure the screw, while the other is involved in a rotation task to tighten / loosen the bolt. This aid has 5 different peg head shapes for various levels of difficulty of gripping using the fingers. Dimensions: (cm) 39.5 x 17.5 x 13.8 h; Weight: 2 kg



Teorema Project Other libraries of aids

AR10016 ELECTRICITY

To activate the switch, the finger must be positioned on the correct half of the button. This task can also be done using two fingers. To do a rhythmic alternating movement, selectivity is required in calling on the two fingers to flex in succession. Inserting a plug in a socket is a task that calls for attention, coordination and evaluation of the force to do so safely. The patient must grip the two elements firmly in their hands and connect them to one another.

Dimensions: (cm) 39.5 x 17.5 x 8.5 h; Weight: 1.3 kg



AR10020 LACES

Positioned on a table: In this position the task is made easier than when positioned vertically, due to the fact that the patient is not tired out by having to keep their arms raised and stabilised during the task.

Positioned on a vertical panel: To do these tasks, applying pressure by opposing endings is essential. This grip is finer and more precise because it makes it possible to hold an object securely. The thumb opposes the pulp side end of the end of the index finger, gripping the lace and the prone supination movements of the forearm, associated with flexing the wrist, make it possible to do the task and threading the lace through the various holes. For both these tasks the side of the hand acts to stabilise the object, and good coordination is essential to complete the tasks.

Bear in mind that even a minor injury that damages these articular areas can compromise this pincer grip - in fact, complete passive articular control of the distal IF on the second finger is required as well as stability of the deep flexor and synchronised activation of the long flexor in the thumb.

On one side this aid has laces with holes and "eyelets" (closed rings), and on the other laces hooked in an "oblique" direction by chromed hooks, both of which are found on many types of footwear.

Dimensions: (cm) 39.5 x 17.5 x 2.5 h; Weight: 1.1 kg



AR10019 CLIPS AND BUTTONS

As regards the aid with the four press studs, significant pressure force is required from the tip of the first finger.

The Trapeziometacarpal joint must be kept in the most suitable position between the bone ends, by the action of the intrinsic muscles that contract to stabilise the joint. The aim is to reduce radial dislocation of the metacarpal while applying force with the thumb, because this is a cause of pain for rhizoid arthritis pathologies.

As regards the task of doing up buttons, greater precision and independence of action by each finger is essential.

The thumb uses the pulp part to oppose the index and middle fingers, to tilt the button and push it into the button hole. Incorrect terminal opposition makes this task impossible, due to the shape of the object. The aid comprises 4 press studs on the one side and 4 buttons like those found on many items of clothing on the other side. Dimensionis (cm) 39.5 x 17.5 x 2.5 h; Weight: 1.2 kg



AR10021 BUCKLES

Good eye-hand coordination is required to insert the buckle. To tension the parts once inserted, a sub termino-lateral grip is used.

The palm face of the thumb's pulp rests on the outer face of the first phalanx on the index finger. The muscles that stabilise the grip are the first dorsal interosseous, that acts on the index finger, the short flexor, the first palm interosseous and abductor of the thumb.

This aid has a clip belt buckle on the one side that can be altered in length, and an end complete with zip that can be opened. The clip belt buckle also requires good coordination and significant force has to be applied by the thumb, opposing the index finger to clip the fixing device in place.

Dimensions: (cm) 39.5 x 17.5 x 4 h; Weight: 1.1 kg



Teorema *Project Ergo mobile station*

AC0654 ERGO MOBILE STATION

This trolley is designed to be used as a place for keeping the various aids, and as a mobile work station. The structure is in metal with three timber shelves, and it has side handles and swivelling castors with individual brakes. The central shelf has a height adjustment. The structure can also have some accessories fitted on it, that extend its use, allowing up to four working positions simultaneously, in a sitting or standing position. Dimensions: (cm) 106 x 68 x 82 h; Peso: 38 kg

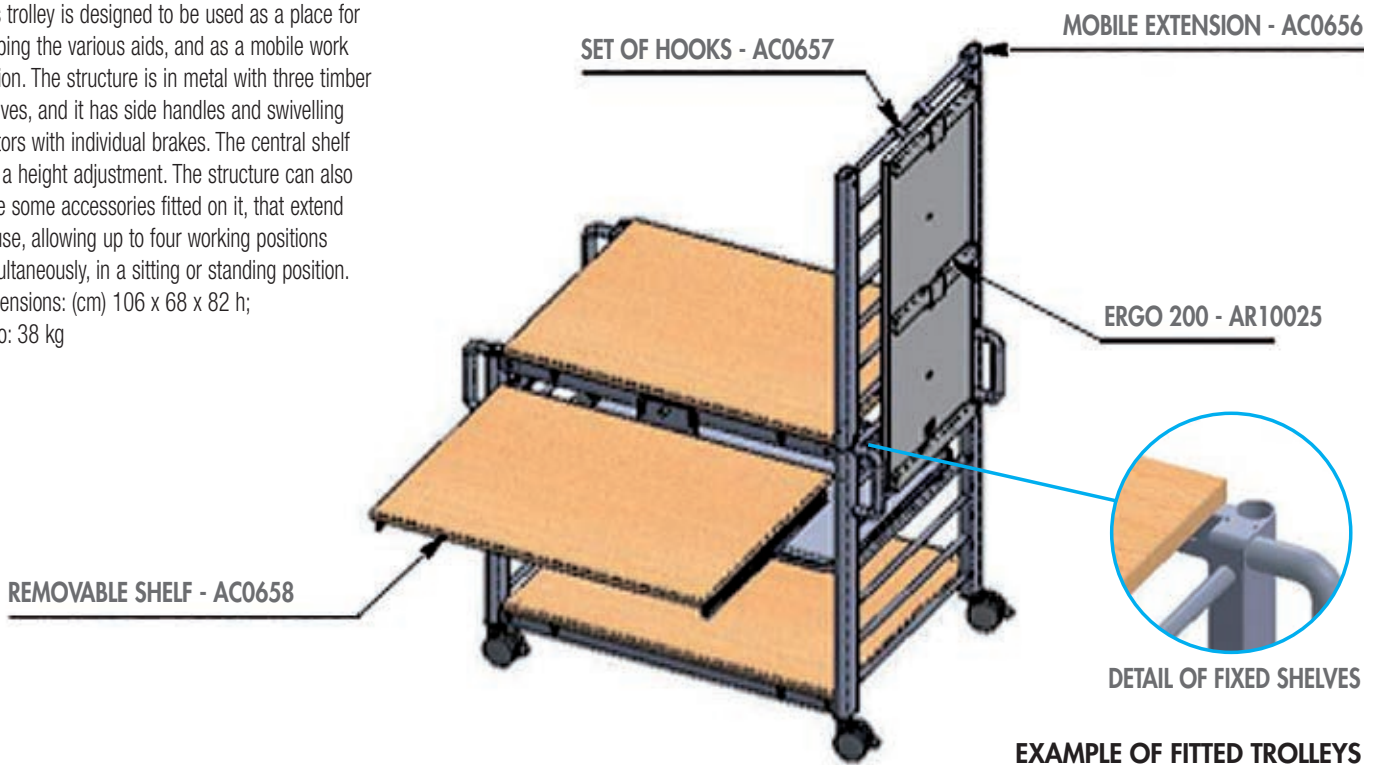

ACCESSORIES



AC0655 FIXED SUPPORT

This element can be fitted on a long side of the Ergo mobile station - code AC0654, and is available to allow another mobile extension accessory to be fitted - code AC0656; Dimensions: (cm) 62.5 x 3 x 71 h; Weight: 1.2 kg



AC0656 MOBILE EXTENSION

This is inserted into the specific seating on the short sides of the Ergo mobile station - code AC0654, or on the additional fixed support - code AC0655, and is used to extend the structure vertically and to allow configurable Ergo 100, Ergo 200 and container trays - code AC0659 or other equipment to be hooked to it. Dimensions: (cm) 62.5 x 3 x 79 h; Weight: 1.4 kg



AC0657 SET OF PANEL HOOKS

This set of four elements is used to set up configurable ERGO 100 and ERGO 200 panels to be hooked on the vertical structure obtained by fitting the mobile extensions. Hardware for fitting the set on the standard panels provided. Dimensions of an individual hook: (cm) 14.5x 4.5 x 6 h; Weight: 1.1 kg



AC0658 REMOVABLE SHELF

The worktop is inserted into metal guides that run on spheres. It can therefore be used by pulling it out when needed and applying the locking system. Dimensions: (cm) 85.5 x 63 x 8 h (height of worktop above floor level, 73 cm); Weight: 6.5 kg

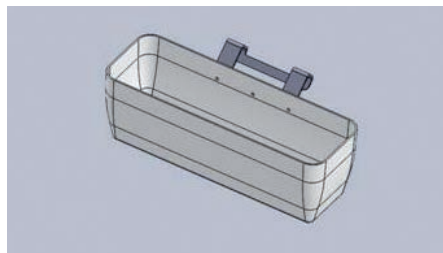

AC0659 CONTAINER TRAY

This is made of plastic and can be hooked to the base structure, or to the extensions fitted on it. The tray can be moved to the required height. Dimensions: (cm) 39 x 13 x 13 h; Weight: 1 kg

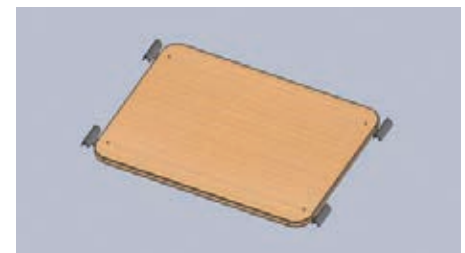

AC0668 ADDITIONAL SHELF

It's a wooden shelf that can be easily applied to the mobile station. It can be fixed on the top of the mobile extensions AC0656 or intermediate positions. Dimensions: (cm) 93 x 58 x 3,5 h; Weight: 5 Kg

POSTURE MONITORING FEEDBACK

By means of this exercise the patient must achieve gradual perfecting of movements, from the complexity required for shoulder, arm, forearm, and elbow movements, to fine movements at the wrist distal, hand and fingers. To make a stable position possible for the arm for which fine use of the hand is activated, proximal control of the trunk is fundamentally important. Attention must not be focused solely on interaction with the aid, but must also take the way the patient uses the various areas of their body into account. Simple gestures like opening / closing a door or window, and taking a glass of water, if included in therapeutic contexts with position monitoring instruments, are very useful for correct functional relearning. The use of position feedback instruments (inclinometer - protractor) makes it possible to draw the patient's attention to the motorial behaviour of areas of their body, of which the patient is not always fully aware, providing information on performance, and focusing attention on important aspects of the gesture. Also adding Feedback has a motivating effect and produces an immediate increase in performance.

Alessandro Crippa, Physiotherapist.



The video shows how it's easy to do the application of the Inclinometer on the patient before making occupational exercises with interest at the same time for a trunk control.

08258 CUBE THERAPY

A Plexiglas cube for rehabilitation of the wrist and fingers. The exercise involves tightening and loosening nuts in the holes formed in the cube's sides.

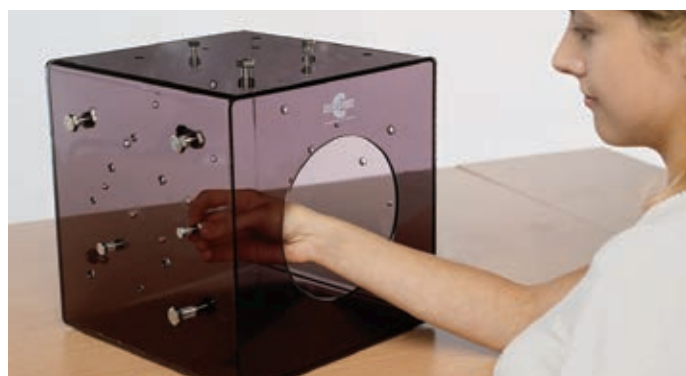

Posture Monitoring Feedback

02036 INCLINOMETER

The inclinometer is a sensor that closes an electric circuit when movements occur on the frontal - saggital plane, providing position feedback, as it reads absolute movements of the body (trunk movements, in the examples that follow) and provides information on them.

The signalling device can be visual, acoustic or vibratory. Visual feedback (FB) is useful when "setting" the instrument, to determine the angle beyond which the patient will feel the stimulus (sound / vibration). This avoids confusion being created, by providing the patient with a signal only when correctly set. In the most advanced learning stage, self-evaluation exercises are provided for ("summary feedback") in which the therapist watches the LED and has an objective parameter to compare with the perception expressed by the patient while executing a series of tests. Sound FB is commonly used because it informs the patient timeously and precisely, drawing their attention to the motorial behaviour of the area involved.

It is particularly useful for patients that tend to have limited attentive participation in the treatment. Vibrating FB is provided by a "vibrating pad" 2 cm in diameter, which will be positioned near the area of muscle you wish to stimulate / block. This results in the patient reducing the time lapse between information and response, because they do not have to interpret a sound or LED, but receive the information at the point monitored.

Visual / acoustic / vibratory FB has a warning and alarm meaning in relation to an incorrect gesture (negative FB) or recognition of correct execution (positive FB). For the same movements, the inclinometer is positioned in opposite directions to implement the two different modes (see the images of flexing the trunk, and Compensation n° 7 below)



THE ITEM COMPRISES THE FOLLOWING ELEMENTS :

- INCLINOMETER
- ELECTRICALLY CONNECTED
- VIBRATING PAD
- INCLINOMETER SUPPORT
- THORACIC VIEWER
- STRIP FOR THORACIC VIEWER
- ADDITIONAL ACOUSTIC SIGNALLING DEVICE



To set the range beyond which the feedback is activated, simply adjust the antenna, changing the tilt on it. The closer it is to the horizontal position, the more sensitive it will be to movements on that plane. The antenna is screwed to a support that is positioned using a velcro strip on the front or back of the thoracic viewer strap. In the two images above information is provided on movements in the frontal plane (lt-rt inclination). In the images below the reference plane is the saggital (flexing - extending).

The positional feedback inclinometer and protractor dealt with here are part of a larger set of rehabilitation aids named LEONARDO and explained in the Rehabilitation section of this catalogue.

02037 PROTRACTOR

This is an elastic structure that follows the patient's movements and informs them when they have reached / passed a predefined joint angle.

This aid works on relative angles, also monitoring joints that do not have a stable rotation axis, such as the thoracic scapula because, unlike other joint measuring systems, it is not positioned on the fulcrum, but is moved away in relation to the movement of the joint segments, closing the circuit and activating the sensor.

The instrument is put in place using velcro strips or double-sided tape applied to the skin. Adjustment is done by changing the length of a cable laid parallel to the elastic. When doing the exercises if elevation, tipping or rotation of the thoracic scapula is picked up, when it should be stabilised, the feedback is very effective. Also, given the difficulty of correctly perceiving the area, application of the vibrating pad on the muscle group to be activated, facilitates control.

NOTE: This aid can also be used for other joints and various "tasks".

THE ITEM COMPRISES THE FOLLOWING ELEMENTS:

- THORACIC VIEWER STRAP
- ADDITIONAL ACOUSTIC SIGNALLING DEVICE
- VIBRATING PAD
- VELCRO STRIP FOR PROTRACTOR
- PROTRACTOR



02038 POSITIONAL FEEDBACK

This set comprises two positional feedback devices known as an Inclinometer and Protractor. They can provide a visual, sound, or vibratory signal if incorrect posture occurs when a patient is busy doing some work. The feedback device to be positioned on the patient is chosen to suit the type of compensation to be monitored. See the description of the individual items contained in these pages and the illustration of the compensations below.



Explanation of how to use the TILT ERGO structure - code AR10007 to perform an exercise on an inclined plane, with postural feedback

When the elastic element is positioned behind the elbow (as in the figure) a range is determined, beyond which the FB is activated. By inverting the position, one can ask for a certain degree of extension to be reached / exceeded (positive FB). For each of the items described on the previous pages the protractor can be used if you want to draw the patient's attention to the behaviour of the proximal joints.



COMPENSATION 1 ELEVATING THE SCAPULA

In this task involving reaching the handle, there is a need to avoid the patient compensating by using the scapula-thoracic joint, to make a movement that must physiologically mainly be carried out by the scapulohumeral joint. The proximal part of the protractor is positioned using double-sided tape at the scapular spine and the velcro strip is used to connect the lower part to the thoracic strap. By adjusting the wire the range of elevation for the scapula is defined, beyond which the circuit is closed and the FB signal is activated.

INCORRECT POSITION



CORRECT POSITION



Plane	Posture	Task	Compensation	Tool	Type of FB
Frontal	Standing	Reaching the handle	Elevating the scapula	Protractor	Negative feedback

COMPENSATION 2 EXTENSION OF THE TRUNK

For this exercise, the patient's difficulty may be linked to a flexing deficit for the arm. Applying the inclinometer to the back immediately indicates any compensation by extending the trunk during the task of positioning an item in the support. Below an arm flexion of 120°-150° in fact, the trunk should not be involved.

In this case too, as in the previous case, being able to adjust the support to the required height, allows the therapist to work on the specific nature of the functional task. As for all the exercises with FB, the task can be made easier or more difficult by adjusting the inclination of the antenna.



Plane	Posture	Task	Compensation	Tool	Type of FB
Sagittal	Standing	Putting an item on a shelf	Extension of the trunk	Inclinometer	Negative feedback

01378 DYNAMOMETERS KIT FOR HANDS

This kit consists of three instruments contained in a convenient case. They can be used for different purposes in standard screening and diagnosis of hand traumas and conditions.

Dimensions: (cm) 31 x 23 x 10 h - 1.5 kg

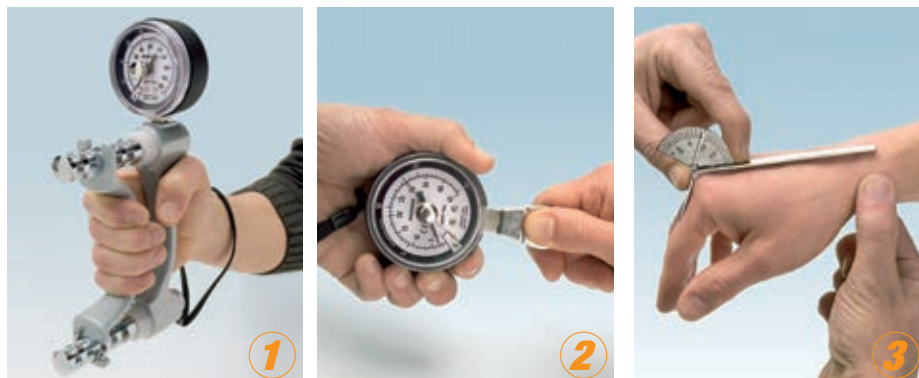

5

1 The Hydraulic Dynamometer for hands

is designed for reliable and consistent operation over time.

It is a precision instrument that may lose its accuracy if not used properly. Make sure the patient is wearing the safety strap to minimise the risks of accidentally dropping the instrument.

2 Hydraulic Dynamometer for fingers,

for a true and accurate measurement of the pressure applied. During measurements, the dynamometer is held by the therapist while the patient only applies pressure with his/her fingers. The reading remains on the indicator until it is reset.

3 Protractor for fingers, a stainless steel

instrument that is ideal for measuring metacarpal, phalangeal and interphalangeal joints. Degrees are displayed on both sides of the protractor.

Functions

Dual scale reading.

Displays the force of pressure in pounds and kilogrammes, with a maximum reading of 200 lb or 90 kg.

Needle with peak-hold function.

For convenience and to simplify data recording, the highest reading, which is shown by the needle with peak-hold function, is automatically saved. The reading remains on the indicator until it is reset.

Accuracy and repeatability.

When in use, it is isometric, with almost imperceptible grip movements regardless of pressure force. This ensures accurate and repeatable results.

Adjustable handle.

The handle adjusts to five positions to fit different size hands: from 1.3/8" to 3.3/8", in half inch increments. Because the pressure force can vary even for the same patient, this function allows the therapist to measure the pressure force with different size objects.

Advantages

Some patients may be reluctant to apply maximum strength when undergoing pressure evaluation tests. Repeating the test after a short rest break allows you to understand if a patient is applying maximum strength.

1. Test pressure in the usual way, taking the readings with the handle in each position of the dynamometer.
2. Perform the test on the healthy hand and then on the injured hand. Allow the patient to see the readings.
3. Repeat the test after a five minute break.

As a rule, if a patient has applied his/her maximum strength, the readings in the various pressure positions only vary by less than 10%. However, if a patient has not applied his/her maximum strength, tests results are inconsistent and show greater variations.

01051

VIGORIMETER

An instrument that measures the exact strength of each finger or of the whole hand. Suitable for: central nervous disorders; disorders related to bone marrow conditions; muscular system disorders.

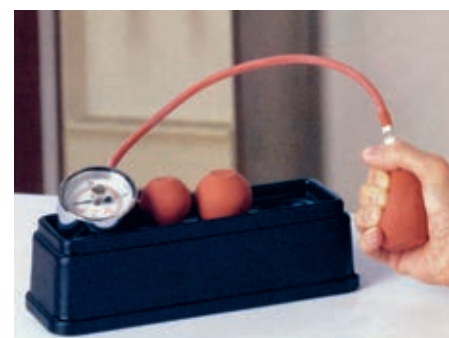

Occupational tables

Occupational tables with a variety of adjustment options to suit all users. Painted steel frame, with a wooden work top that can gradually be tilted up to 45° or 90° to the front. Gas spring or manual height adjustment.



08461 FUNCTIONAL TABLE

Tilt-top table with a maximum 45° tilt. Gas spring height adjustment. Dimensions: (cm) 90 x 70 x 68÷92 h



08475 FUNCTIONAL TABLE Q

Fixed top and middle cut-out. Gas spring height adjustment. Dimensions: (cm) 120 x 90 x 68÷92h



08477 FUNCTIONAL TABLE FI

Two-section top. One section is fixed and has a cut-out, and one section can be tilted. Gas spring height adjustment. Dimensions: (cm) 90 x 90 x 68÷92h



08464 FUNCTIONAL TABLE F

Middle section tilts up to 45°, two side sections are fixed. Gas spring height adjustment. Dimensions: (cm) 20+50+20 x 70 x 68÷92 h

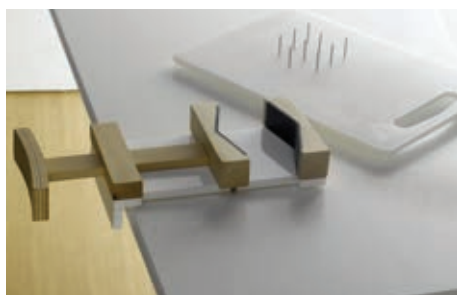

02039 TABLE CLAMP AND CUTTING BOARD FOR THE DISABLED

This aid is made up of two elements: a table clamp and cutting board. The "clamp" rests on the edge of the table top and by exerting gentle pressure with your side, you can grip the item you want to use with your good hand. This makes it possible to unscrew jar tops of various sizes, open cans, and grip containers and other items, easily and safely. The cutting board is made to fit on top of the clamp and the stainless steel spikes in it make it possible to trap various types of food to be cut, peeled, or grated. Do not wash in a dishwasher.

TABLE CLAMP Dimensions: (cm) 12 x 25 x 4; Peso: gr 600 - CUTTING BOARD Dimensions: (cm) 24 x 34 x 2; Weight: 800 g



08476 FUNCTIONAL TABLE RF
Fixed table top. Gas spring height adjustment.
Dimensions: (cm) 120 x 90 x 68÷92h



08478 TAVOLO ERGO FT
Table top with a maximum 90° tilt. Manual height adjustment.
Dimensions: (cm) 140 x 80 x 70÷120h



08462 FUNCTIONAL TABLE DF
Split-top table: left section tilts up to 45°, right section is fixed.
Gas spring height adjustment.
Dimensions: (cm) 60+30 x 70 x 68÷92h



08480 ERGO TABLE MC
Ergonomic table, two-section top. The monitor shelf can be tilted from 0° to -25°, the other section is fixed. Gas spring height adjustment.
Dimensions: (cm) 120 x 60+40 x 72÷120h

08463 FUNCTIONAL TABLE SF
Same as item code 08462, but with tops inverted (left section is fixed, right section is tiltable). Dimensions: (cm) 30+60 x 70 x 68÷92 h

ANCHORS facilitated unaided movement

The anchors are versatile, portable and durable, and can be placed on flat, smooth and clean surfaces. Increasing hand and arm stability benefits control over the head and trunk.



01608 HAND ANCHOR
This ergonomic anchor can be applied to any smooth surface to achieve greater stability and safe positioning of the hand.



01609 WRIST ANCHOR
This is provided with a resting pillow and Velcro wristband to ensure the hand is positioned in total safety.

More options



47020 CUBELAND 1

Set of 16 dice for compositions. Supplied with two guide books.



47030 CUBELAND 2

Set of 27 wooden dice with coloured faces for three-dimensional compositions. Supplied with 47 guide cards.



47090 EIGHT-SHAPED CAT

Wooden table game with compulsory track grooves to improve eye movement coordination.



47120 TAST-MEMORY

This game helps to develop memory and sensory skills.



47110 MEMORY

Game for motor and cognitive skills.



47060 NEUROTTEST

This game uses aluminium to improve tactile sensitivity. Innovative material due to its high heat conductivity.



47050 ABILITY

This game has aluminium pieces and a board with a series of holes in parallel rows in it, and requires concentration, fine motor skills and tactile sensitivity.



01052 ERGO SET 1

Basic home ergotherapy session kit, supplied with a small hard case for transport. The case contains aids suitable for therapies involving concentration, motorial sensation and cognitive exercises, also used in neuropsychological tests, eye-hand coordination, colour and shape recognition. Dimensions: (cm) 40 x 30 x 32 h



An exercising tool made up of wooden discs that move independently and unpredictably useful for improving motorial control, coordination and concentration, balance and reflexes, visual perception, musculature and joints in the upper limbs.

XI001 INIMOVE COMPLEX 4

With 4 movable discs.

XI002 INIMOVE COMPLEX 6

With 6 movable discs.

XI003 INIMOVE COMPLEX 8

With 8 movable discs.

Chinesport, just a click away

Chinesport's website has now also been designed and set up for those using mobile phones or iPads, not necessarily because they are out-and-about or travelling, but because they wish to know more about it while using our catalogue or other documentation. We are constantly involved in publishing new detailed information, photos (now even bigger), videos and multimedia files that are worth sharing. Finally, the website also provides a guide to putting the code together for a product made up of a number of parts.



Point, and explore the video!



REHABILITATION and MEDICAL EQUIPMENT

CHINESPORT spa
Via Croazia, 2
33100 Udine - Italy
Tel. 0432 621 621

www.chinesport.com

