



PROFESSIONAL SERIES GAS HEATERS



**X94 Professional**  
High Efficiency Pool and Spa Heater



# NO ONE PUTS MORE INTO THEIR POOL HEATERS

Introducing the Raypak X94 Professional series pool heater, designed specifically for commercial properties such as apartments, condos, hotels, motels, schools, parks, community and high-end private pools. It's also the perfect heater for tough coastal weather conditions where salt air challenges durability. When your reputation is on the line every day, you've got to work smart and come prepared with strength, experience, and the guts to lead the way. In a word, it demands a Raypak Professional series pool heater.

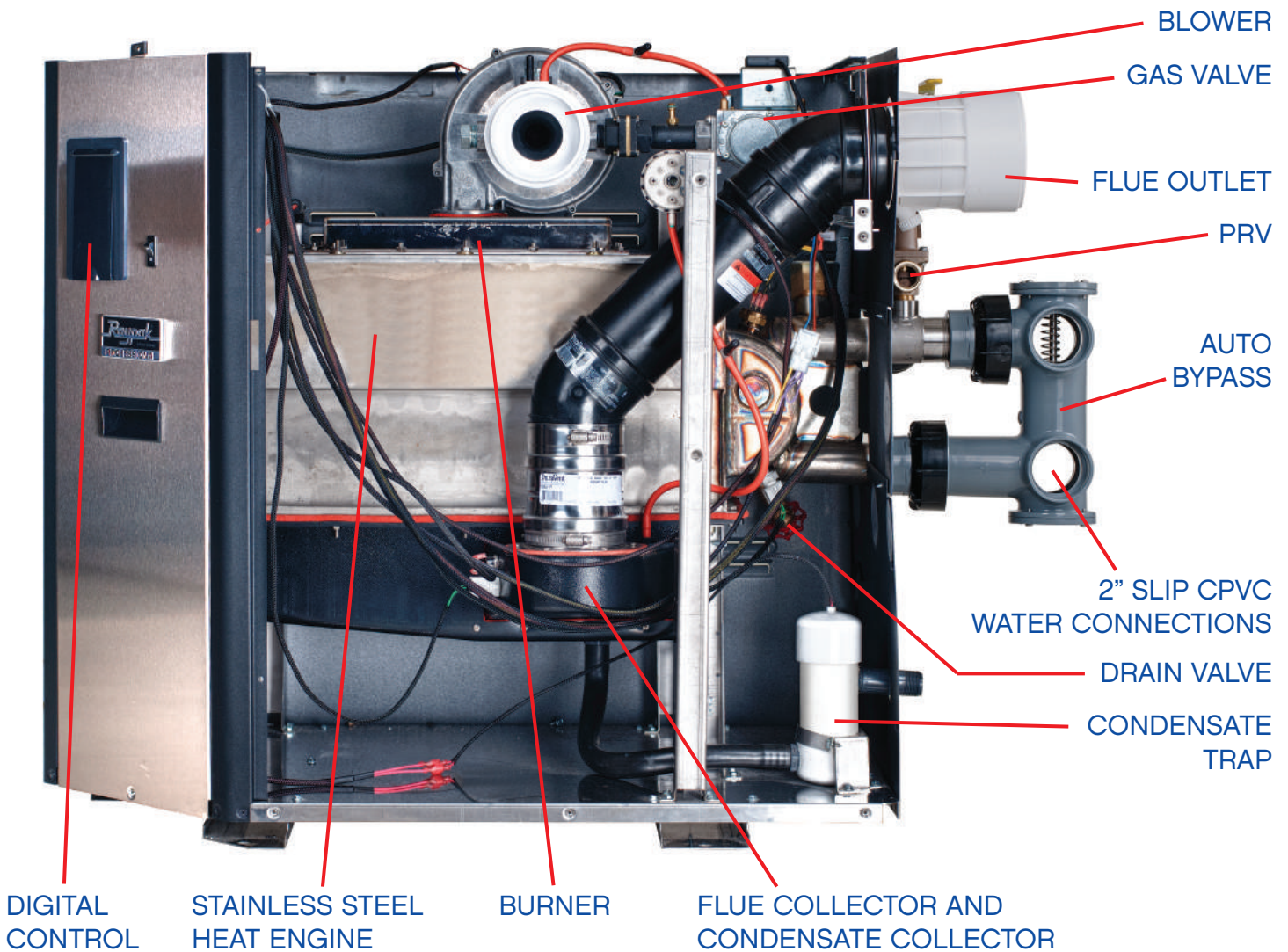

## PROFESSIONAL HERITAGE



Built by a company dedicated to water heating, and refined through more than six decades of year-round demanding use in commercial boiler rooms, Raypak Professional heaters embody the durability, longevity and flexibility that the true pool professional expects. Many of the X94 Professional pool heater features come directly from our years of commercial boiler experience. This knowledge and experience is unmatched in the pool heating industry.

# X94 PROFESSIONAL - IN A CATEGORY ALL ITS OWN

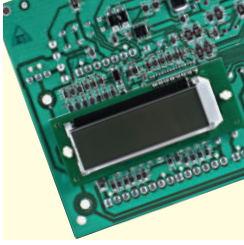

## MICROPROCESSOR

control is more precise than mechanical systems. It controls temperatures for pool and spa settings and stores diagnostic information for service technicians.



## STAINLESS STEEL

is used liberally throughout the X94 Professional pool heater. Raypak spared no expense to ensure that any area that could be compromised by harsh environments would stand the test of time.



## HEAT EXCHANGER

The first gas-fired pool heater to use a stainless steel heat exchanger designed specifically for pool heating. Excellent for salt chlorine generated pools.



## PLUMBING CONNECTIONS

Multi-port plumbing options are simple with 2" CPVC slip connections. Raypak supplies two 2" CPVC plugs so you can tailor the installation to your specific needs.



## CONDENSATE TRAP

This allows for the combustion condensate to gather safely without any of the flue gases leaking out. We provide a 3/4" CPVC stub out to route your condensate to a neutralizer (not supplied).



## DIRECT SPARK IGNITION

High-voltage spark provides a quick and smooth burner light off. Flame sensing and rectification are provided by the spark electrode and built-in sensing probe.



## DIRECT VENT CAPABLE

Flue exhaust vented up to 65 ft. with 4" and 150 ft. with 5" or 6" without the use of an extractor. Inlet combustion air can be ducted through PVC, ABS, CPVC, or galvanized steel duct. See manual for specifics.



## 94% EFFICIENCY

Certified and listed at 94% thermal efficiency. In addition to this high efficiency, the X94 Professional is also low NO<sub>x</sub> compliant in all 50 states. This is the greenest Raypak pool heater we have ever built!

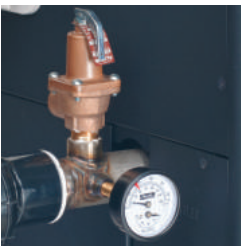

## FLOW SWITCH, T&P and PRV

50 state ASME compliant right out of the box. Flow switch eliminates possible "false" water flow issues from above/below grade pools. No additional parts to buy to make your heater commercial code compliant.

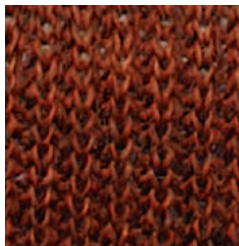

## METAL FIBER MESH BURNER

Our unique flat burner design is a 3D knitted structure made from FeCrAlloy® yarn. This design is made for high temperature and low oxidation operation. Designed to operate at low and high inputs without flashback.



## WIRING SHEATH

is standard construction on all exposed wiring. This helps prevent rodent damage and other associated issues that can damage the wiring. Not to mention it looks great!



## WARRANTY

The Raypak Professional is unmatched in warranty for commercial applications: Three years parts and labor. We stand behind what we believe in.



# A DIGITAL CONTROL SO SOPHISTICATED, YET SO SIMPLE TO USE

## Microprocessor-Controlled Thermostat

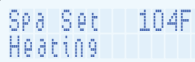

Spa Set 104F  
Heating

The Raypak X94 Professional gas heater is equipped with a microprocessor-based control. This control allows you to set your pool and spa temperature precisely at your preferred setting just by pressing an up or down temperature control button. The digital display tells you when the water is being heated and notifies you when your target temperature has been reached.



Spa Set 104F  
No Demand

## Self-Diagnostic

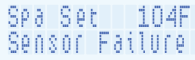

Spa Set 104F  
Sensor Failure

Troubleshooting a Raypak gas heater has never been easier. The Raypak Professional has on-board diagnostic controls that let the user and the service professional know what is going on with the heater at all times. The display uses real English, with no cryptic codes to decipher.

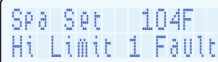

Spa Set 104F  
Hi Limit 1 Fault

## Remote-Compatible



Remote Pool 104F  
Water Temp 69F

The Raypak X94 Professional is compatible with most major pool controls and remote systems on the market today. Any two- or three-wire remote can connect to the Raypak X94 Professional and be integrated into the pool control system of your choice. The display clearly shows the heater is under control of a remote system.

## Run Time and Cycle Meter



Run Time 100h  
Cycles 134

Another industry first, the Raypak pool heater can report how long it has run and how many times it has fired the main burner. This is valuable feedback for the service professional. Multi-unit installations can monitor the run time of each unit and balance out the duty load, thus avoiding overworking one individual heater.

## Flame Strength Indicator



Flame Strength  
■■■■■■■ 8 Good

Raypak leads the way with the first control in the pool industry to monitor and measure the flame signal. Known for our high quality, leading edge commercial boilers, it just made sense for Raypak to use this existing commercial technology on our pool heaters. This little tool is a service tech's dream. Raypak also uses this function on the end-of-line test, making sure every heater leaves with a strong flame signal.

## On Board Voltmeter

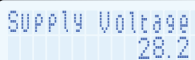

Supply Voltage  
28.2

The Raypak digital control is so smart it can monitor the low voltage electrical supply from the transformer. This helps eliminate miswiring during installation. It lets the installer know if the unit is wired for 240V when 120V is supplied and vice-versa. The heater will also let you know if the voltage has dropped too low to function properly. No other pool heater takes care of you like a Raypak and no other pool heater has this function built in.

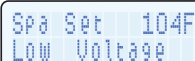

Spa Set 104F  
Low Voltage



## Flue Gas Temperature Monitoring



Flue Monitor  
CPVC/PP

The X94 comes standard with a built-in flue gas high limit located in the flue collector. This allows you to use PVC, CPVC or Polypro without having to buy any accessories to run the low temp flue pipe.

## Fan Speed - High Altitude Adjustment



Max Fan RPM  
7500

High altitude operation can be dialed in at the job site to maximize the combustion flue gases. The blower fan can safely be fine-tuned through the digital control. This feature is also helpful with long intake air ducting or to help reduce fan noise. The user can adjust the fan speed between 7000rpm and 7500rpm.

## Freeze Protection



Freeze Protect  
Enabled

When freeze protection is enabled (when pump operation is enabled) the control will monitor the water temperature. If it falls below 40°F the pump will turn on for 15 minutes. After 15 minutes the pump will shut off once the water exceeds 42°F.

## MORE CONTROL - LESS HASSLE

The Raypak X94 Professional gas heater is equipped with an enhanced functionality board as seen in the photo below. This control works in conjunction with the standard ignition control board and offers expanded functionality required to operate the variable speed fan. In addition to the fan control, the board also allows for a pump time clock function, pump speed controller, 3-way valve controller, freeze protection and burner modulation control. All programming is done through the standard control LCD display.



### Time Clock

```
Run Schedule A
Off Wed 2:06P
```

With the built-in time clock function you can program the pump for a 7 day schedule. It can be set for up to 4 different operating periods per day. There is also an option to set 2 different schedules, schedule A and schedule B. A manual override feature for service or operation outside the schedule is provided.

### Pump Speed Controller

```
Pump Operation
2 Speed
```

The controller can handle any type of pump from a single speed, dual speed, 4-speed or variable speed. Variable speed is handled through a direct PWM signal. The pump can also be programmed to boost the flow automatically when there is a call for heat in Pool or Spa mode.

### 3-Way Valve Controller

```
Valve Operation
Enabled
```

3-way water valve control is possible when pump operation is enabled. The control allows you to program the suction and return valves to the desired position. There is also an option to allow a "Valve Change Delay". This turns the pump off for 30 seconds to allow the valves to rotate into position without the pump running.

### Full Burner Control- Industry First Eco Mode • Turbo Mode • Comfort Mode

```
Pool Fan Mode
Turbo-Rapid Heat
```

Another industry first, the Raypak X94 can adjust the amount of input to the burner. Turbo mode is standard full-fire operation. Eco Mode is a reduced input rate which can be used for added energy savings or to reduce short cycling. Comfort Mode is for Spa mode and reduces the burner input as the water approaches the target temperature. Once the water is within 1.5°F of the set point, the burner modulates the input rate down to match the heating load. This feature helps keep the water comfortable and reduces short cycling.

### Easy Multiple Unit Nesting

Designed with multiple unit installations in mind, the X94 lends itself to space saving installations. All connections, except for combustion air, are located on the rear of the unit for clean installations and easy access to the heater. The unique angled front control panel allows unobstructed access to the controls when the units are installed side by side. Unit is serviceable from the top of the unit and the two front doors. With such a small footprint and close nesting capability, you can install 3 X94 heaters with just under 1.2 million BTU of input and take up less than 22 square feet!





# INSTALLATION FLEXIBILITY

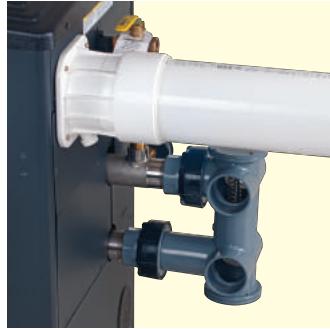

## Venting Material Options

### PVC, CPVC, Polypro or Stainless Steel

The X94 Professional offers the most venting options of any gas pool heater on the market today. The unit can be installed with PVC, CPVC, Polypro or stainless steel flue vent. The heater is equipped with a multiport vent adapter so no extra parts are required. The heater can also be installed with PVC or metal pipe duct to bring fresh combustion air from outside the equipment room. This is absolutely the perfect solution when chemicals are stored in the equipment room.

## Vent Size Options - 4" standard 5" and 6" optional

With more listed venting sizes than any heater on the market today, you can easily hook up to existing venting faster and more cost effectively. This is perfect for retrofit applications that have different existing vent sizes already on site.

Vent Adapter	Vent and Air Intake	Vent Length		Intake Air Max length
		Min.	Max.	
supplied	4"	5'	65'	65'
4" to 5" not supplied	5"		150'	150'
4" to 6" not supplied	6"			

## Optional Stainless Steel Vent Terminal

The Raypak X94 comes standard with a PVC vent terminal, required for all installations. A stainless steel version is available as an option.



P/N 015361



P/N 015451

## Optional Condensate Neutralizer

Raypak also offers a condensate neutralizer that is performance matched to the X94. Inexpensive and easy to install and maintain. All PVC construction with limestone rock neutralizer. Raypak makes larger neutralizers that can be used on multiple unit installations. Consult the factory for sizing.

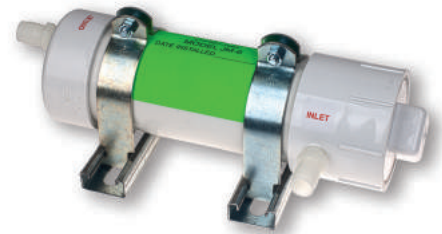

P/N 015199

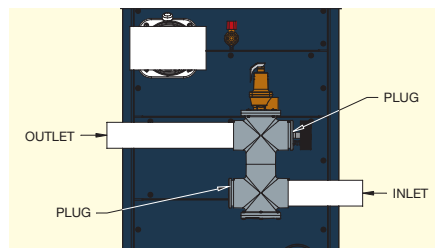
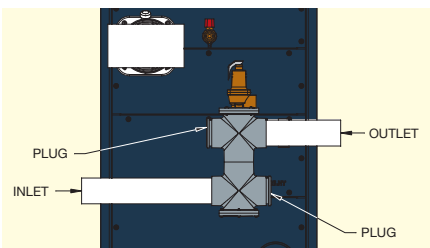
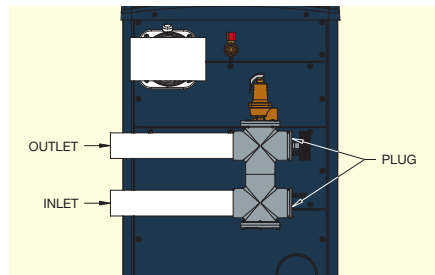
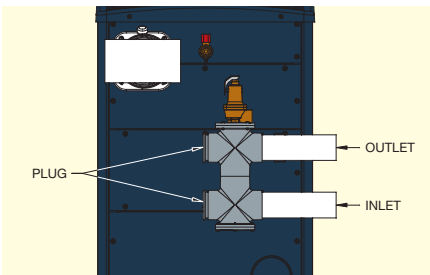

## Multiple Plumbing Options

Another industry first from Raypak - 4 possible water connection configurations. Not only do you have right-handed and left-handed options, but now you have pass-through options as well. You can place the heater in series with your equipment plumbing. The clean, straight piping eliminates or reduces the number of elbows needed, offering you the lowest possible pressure drop. The X94 Professional comes with 2 CPVC plug fittings to allow you full flexibility when installing the unit.

# THE HEART AND SOUL OF THE RAYPAK X94 PROFESSIONAL

---

**AL-6XN<sup>®</sup>**  
*Alloy*

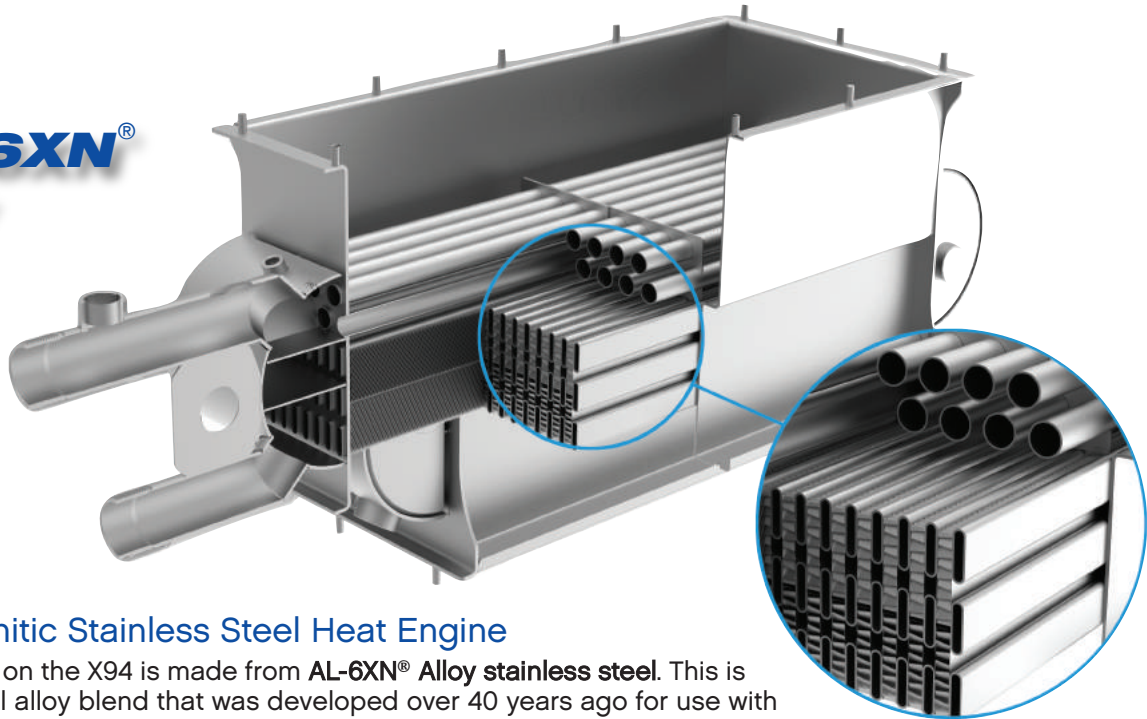

## Super-Austenitic Stainless Steel Heat Engine

The heat engine on the X94 is made from **AL-6XN<sup>®</sup> Alloy stainless steel**. This is a high-end metal alloy blend that was developed over 40 years ago for use with seawater and brackish water conditions. Used primarily in condensers and heat exchangers on offshore oil platforms and power plants. This special alloy blend is far superior in strength, pitting and corrosion resistance than other types of stainless. It is also preferred over titanium and other stainless steels when used in high salt-water applications. Raypak spent over three years developing the perfect heat engine for pool applications. We tested several different types of stainless material and concluded that AL-6XN is far superior to any other material available. Every part of the heat engine is made from this material including the fire box, heat exchange tubes, headers and nipples.

## So What Does This Mean To You?

Believe it or not, pool water is one of the most corrosive water applications for a heater to operate and survive in. Especially with the popularity of salt chlorine generators, the water continues to challenge the life span of pool heaters. The X94 is built specifically for this environment and uses all of the best materials available to provide the longest life for a premium product. No other high efficiency pool heater is built with the advanced alloys and heat engine design as the Raypak X94. There really isn't any competition to the Raypak Professional Series.

## THE MYSTERY OF ASME UNCOVERED

---

The Raypak X94 Professional heater comes standard as an ASME certified and stamped unit. Being in the boiler business for over 60 years truly makes Raypak the leader for your commercial needs. Why ASME? Most local codes require that public pools, pools that are in condominiums, apartments, or other commercial applications, be in compliance with ASME Section IV.

**ASME** stands for **American Society of Mechanical Engineers**, a non-profit group which sets many industrial and manufacturing standards. A pool heater that is made to ASME standards must conform to a set of specifications as determined by ASME, specifically in relation to the operating water pressure the appliance can handle. Each and every ASME heat exchanger that goes into a Raypak Professional heater is inspected to make sure it complies with the ASME Code for pool heaters.

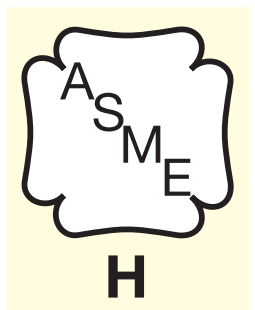

That's why Raypak is the only pool heater manufacturer to supply a flow switch, PRV and T&P gauge standard with every Professional Series gas heater under 400MBTU. We know what it takes to make a unit 50-state ASME compliant right out of the box. Does your heater company make sure all the little details are taken care of like Raypak does, or do you have to make another trip to your distributor to get everything you need?

# Technical Data

## X94 Professional Gas Pool Heaters

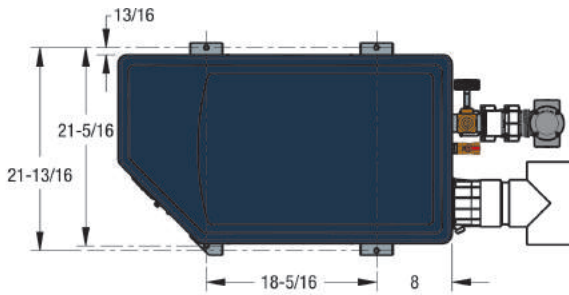

TOP

Amp Draw	
120 volt	240 volt
5	N/A



H

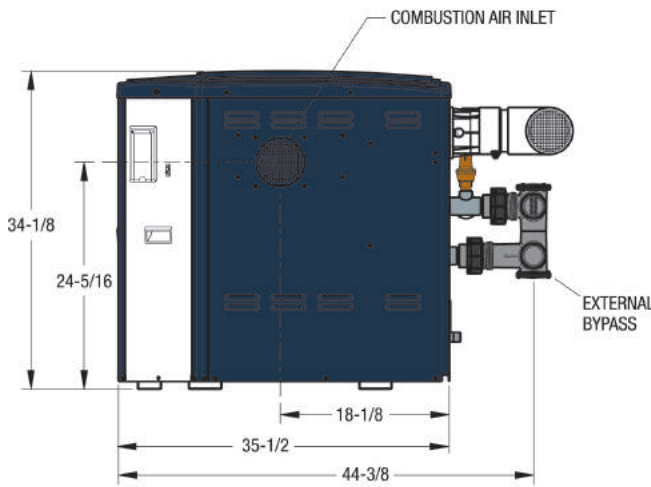

LEFT SIDE

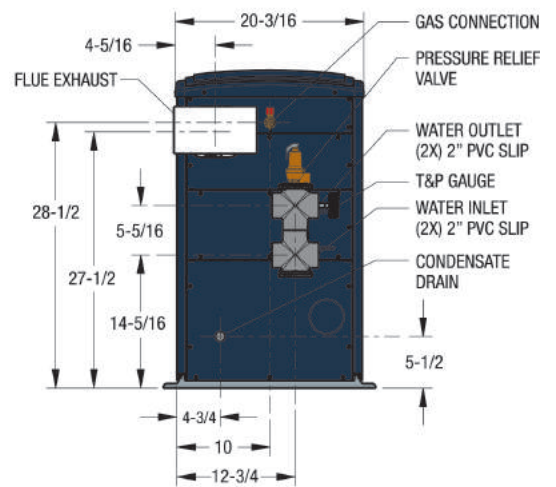

REAR

Heater Model	BTUH Input (000)	(B) Flue Diameter	(C) Air Inlet	Gas Connection	Water Connection	Minimum Flow (gpm)	Maximum Flow (gpm)	Shipping Weights (lbs)
								Complete Unit
S-R410	399.0	4"	4"	3/4"	2"	40	125	300

Designation for a Professional heater using propane gas is "EP"; a Professional heater using natural gas is "EN". Prefix "S" is for stainless steel heat exchanger and headers.

Example: S-R410-EN = Stainless steel heat exchanger, 410 model size, digital, natural gas

Heaters are rated for natural and propane gas up to 4,500 feet. For elevations over 4,500 feet consult the factory.

Heater can be installed directly on a combustible surface.

Flue gases must be properly vented with 4", 5" or 6" CAT IV venting, see I/O manual.

Inlet air can be ducted with 4", 5" or 6" metal or PVC pipe-See I/O manual for complete venting details

*Xtreme performance powered by*



Raypak, Inc. 2151 Eastman Avenue, Oxnard, CA 93030, (805) 278-5300. Fax (800) 872-9725 [www.raypak.com](http://www.raypak.com)

The Pool and Spa Heating Experts<sup>SM</sup>