

How to test a 94-98 Mustang Tachometer & Speedometer

© Mark Olson, Accutach Co.

Rev. 1, 11/12/2011

This is a fairly cheap and easy method for testing the speedometers and tachometers in 1994-1998 Ford Mustang clusters. All you will need is a good well-regulated 12V power supply; a 9 to 12VAC "Wall Wart" style wall transformer (similar to this: <http://search.digikey.com/us/en/products/EPA090050-S%2FT-SZ/T1004-ND/1630760>); a cheap, unregulated battery charger and a half dozen clip-leads (similar to these: <http://www.radioshack.com/product/index.jsp?productId=2062624>) to hook it all together.

You need the well-regulated 12V power supply to provide power to the tachometer and speedometer during testing. If you don't have access to a bench power supply, a charged car or motorcycle battery provides a great power supply. A battery charger is not a regulated power supply, so it will not work to power the speedometer or tachometer.

However, a battery charger can provide a good timing signal for your testing. Here in the US, our AC power frequency is very well controlled at 60Hz. Most battery chargers simply run the AC through a transformer to reduce the voltage and a rectifier bridge to convert it to DC. However, since the AC power is supplied in the form of a 60 Hz sine wave, the rectified sine wave becomes a 120 Hz DC signal such as this one:

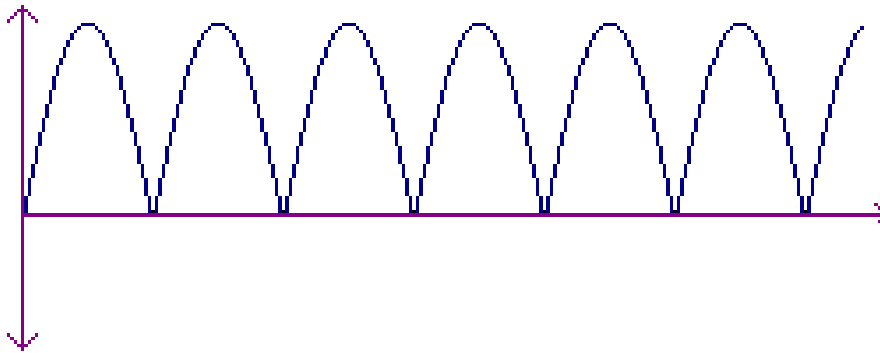

It turns out that this signal is a pretty good signal for testing tachometers, and it works with either a 6V or 12 V battery charger.

The V8 Mustang tachometers use the following formula to relate RPMs shown to frequency input:

$\text{RPMs} = 15 * \text{Frequency}$, so 120 Hz will simulate an 1800 RPM signal.

The V6 Mustang tachometers use the following formula to relate RPMs shown to frequency input:

$\text{RPMs} = 20 * \text{Frequency}$, so 120 Hz will simulate a 2400 RPM signal.

All that is needed to test a tachometer is to power up the tachometer and then feed the output of the battery charger into the tachometer input to ensure that the needle moves and points to the correct RPM.

The following pages show how to hook up the tachometer for testing and for putting the needle back on the tachometer at the correct angle if it has been removed.

Also, a 9-12VAC wall transformer will give you a very accurate 60 Hz AC signal for testing speedometers. The final pages of this document show you how to connect the wall wart style wall transformer to test (or install needles on) a speedometer.

Tachometer Connections

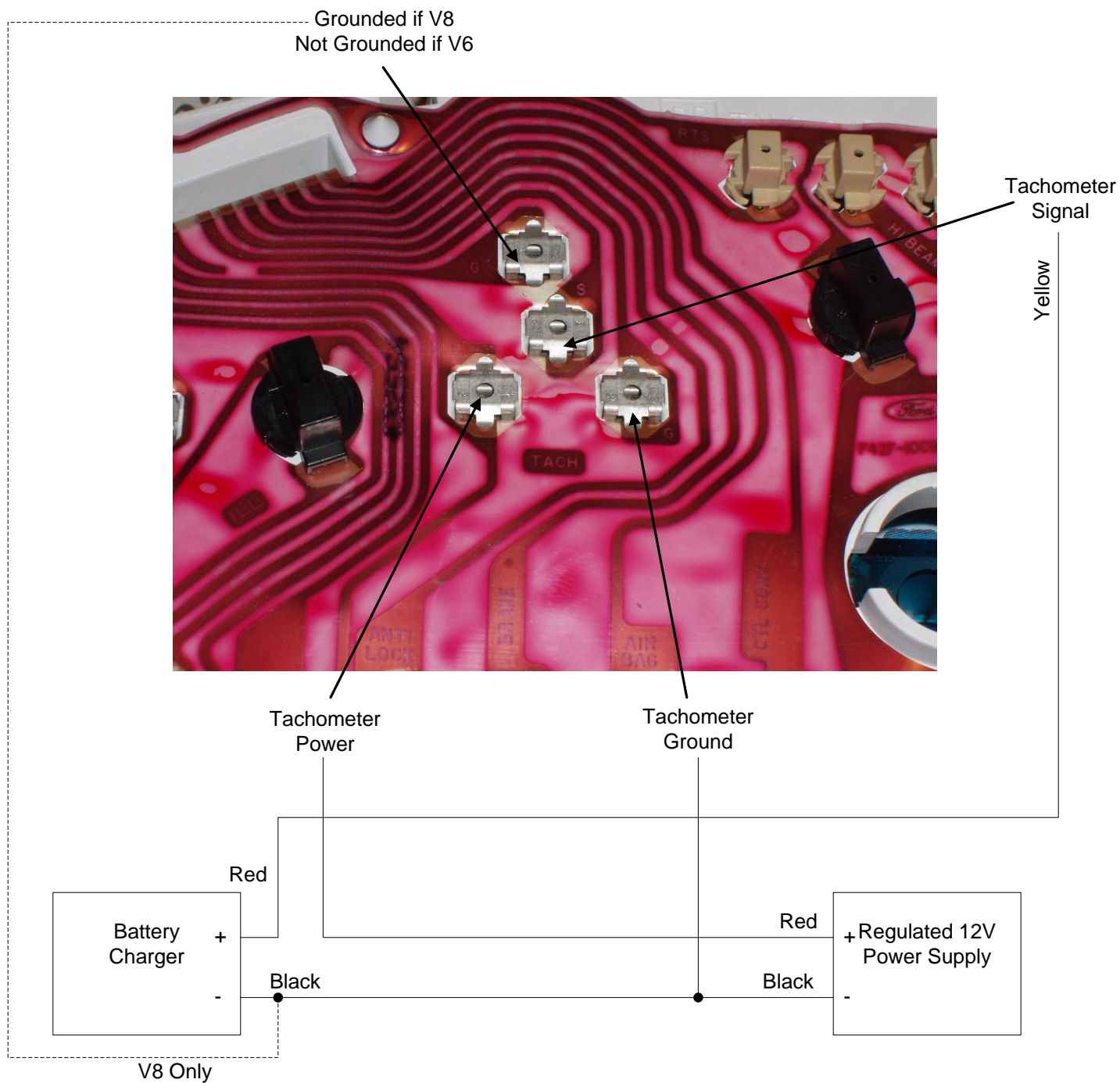

Connect the grounds together. Ground the top tachometer pin if you are testing a V8 tachometer, or leave it unconnected if testing a V6 tachometer. Connect the regulated 12V power to the tachometer power pin. Connect the battery charger power to the tachometer signal pin. (I used a yellow clip-lead for the tachometer signal.)

Battery Charger



Battery Charger Connections

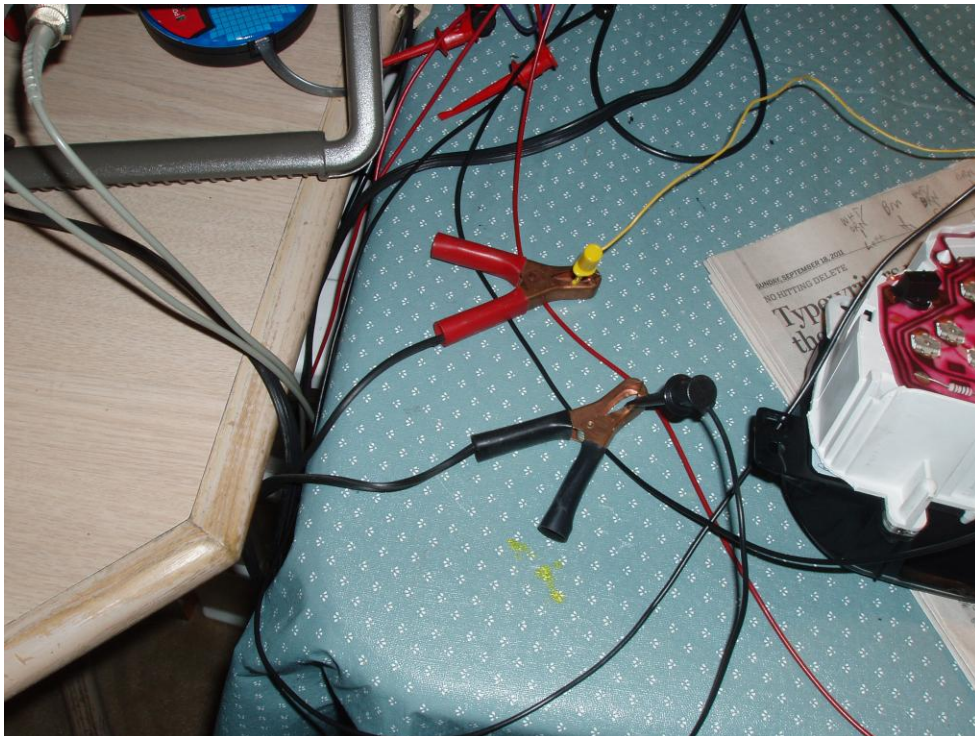

V6 Cluster Connections

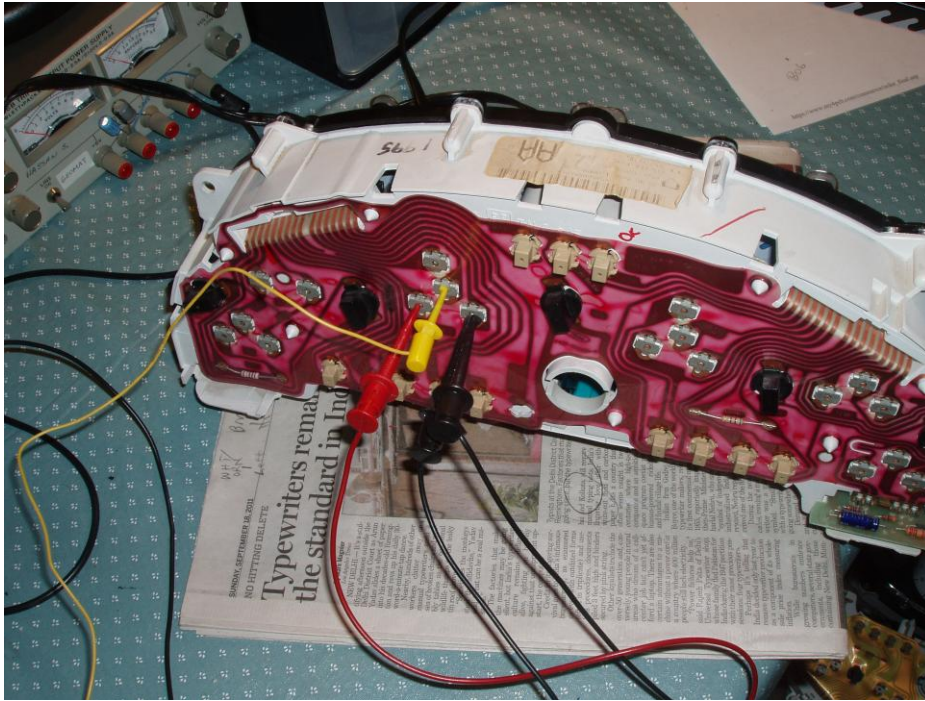

V6 Tachometer Needle



2400 RPM

V8 Cluster Connections

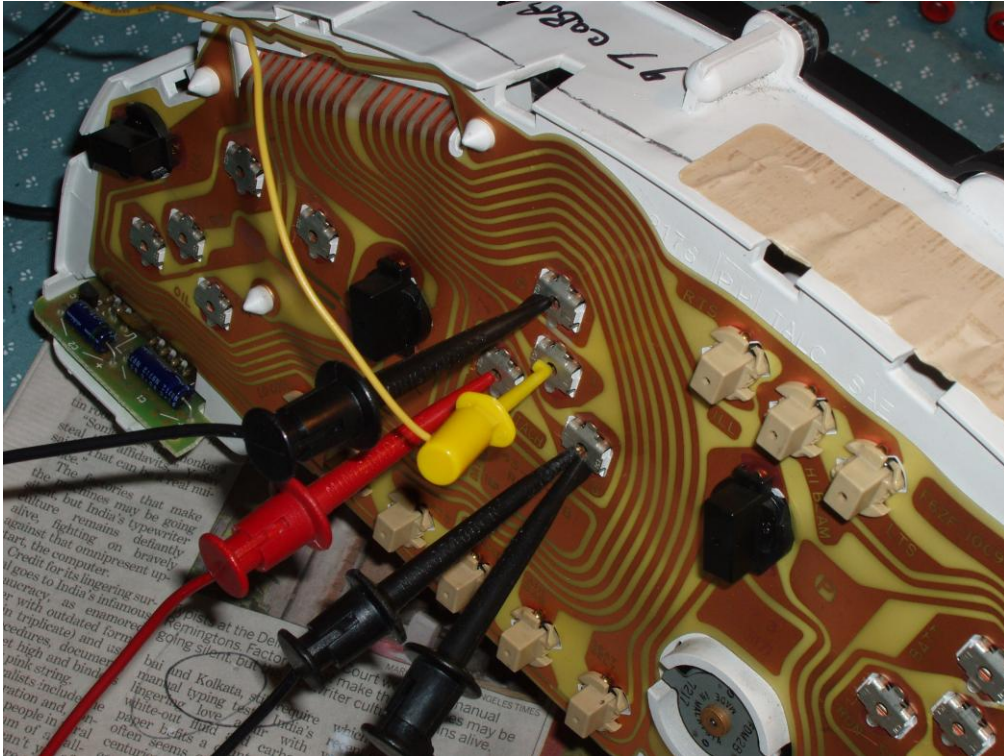

V8 Tachometer Needle



1800 RPM

Speedometer Connections

While the tachometer needs a DC signal to work, the speedometer needs an AC signal in order to work. You will use the 9 to 12 VAC wall transformer for the calibration signal. Since the speedometer expects 8000 pulses per mile, a 60Hz signal corresponds to a 27 MPH VSS signal for both V6 and V8 clusters.

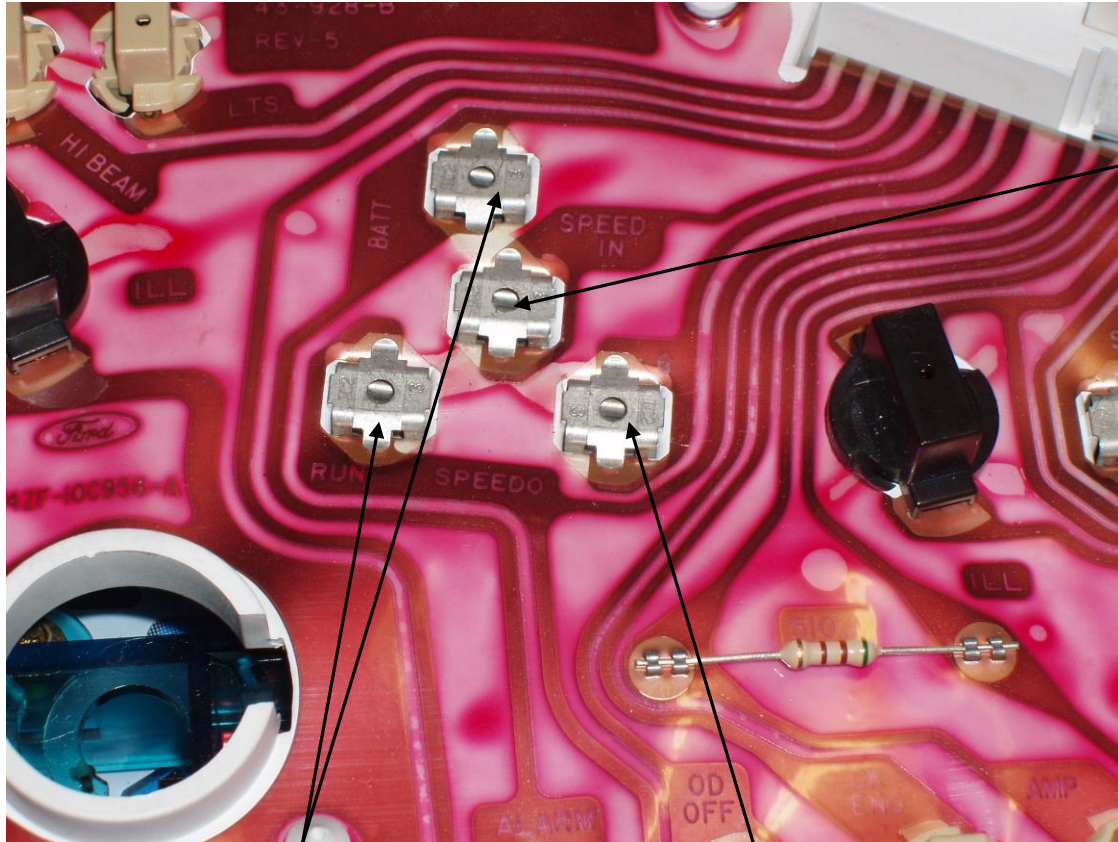

Speedometer
Signal

Yellow

Speedometer
Power

Speedometer
Ground

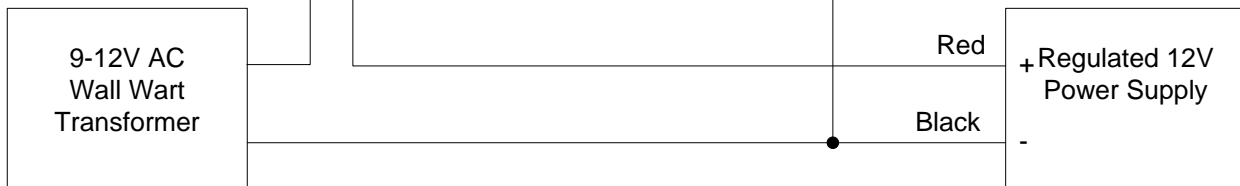

Connect the grounds together. Connect the regulated 12V power to the two speedometer power pins. Connect the wall transformer power to ground and to the tachometer signal pin. (I used a yellow clip-lead.) Since the wall transformer output is AC, the polarity doesn't matter.

“Wall Wart” Style Wall Transformer



Any 9 to 12VAC “Wall Wart” Style Wall Transformer will work.
I had a 9VAC unit in my junk box. This \$7 Digikey units will also work:
<http://search.digikey.com/us/en/products/EPA090050-S%2FT-SZ/T1004-ND/1630760>

Speedometer Cluster Connections

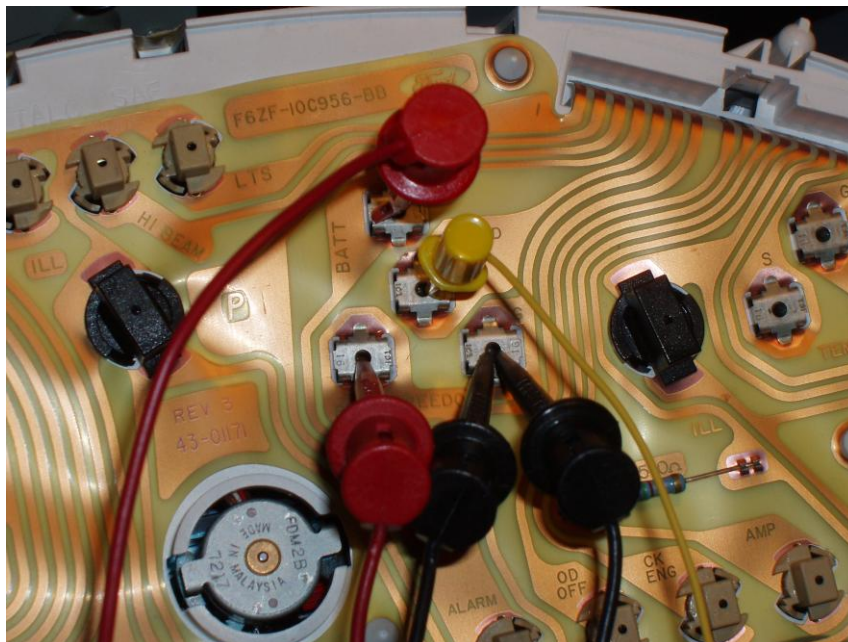

Speedometer Needle



27 MPH

By using these few, inexpensive tools, some of which you may already have, you can test (and calibrate the needles on) your 94-98 Mustang tachometers and speedometers. These techniques will probably also work for other model Ford clusters of the same generation.